

Ill. C. C. No. 15
Original Title Sheet No. 1
Cancelling Ill. C. C. No. 10 In Its Entirety
of Frontier North Inc. f/k/a Verizon North Inc.

Frontier North Inc.
f/k/a Verizon North Inc.

GENERAL EXCHANGE TARIFF
FACILITIES FOR INTRASTATE ACCESS
IN ALL EXCHANGES

Issued: May 10, 2011

By Kenneth Mason
Vice President
Government and Regulatory Affairs

Effective: July 1, 2011

Applies to All Exchanges Illinois

Pursuant to the Public Utilities Act, Ill. Rev. Stat., Ch. 111 2/3, paras. 13-501 and 13-502, Frontier North Inc. hereby adopts all the rates, rules and regulations set forth in Ill. C. C. No. 15 and hereby declares that all services contained in this tariff are noncompetitive services. The Company reserves the right to reclassify any portion of or all of these services as competitive services from time to time in accordance with para. 13-502(c) and (e) of the Public Utilities Act.

Issued: May 10, 2011

Effective: July 1, 2011

By Kenneth Mason
Vice President
Government and Regulatory Affairs

Applies to All Exchanges Illinois

FACILITIES FOR INTRASTATE ACCESS

TABLE OF CONTENTS
Alphabetical Listing

	<u>Section</u>	
Advanced Communications Networks	16	
Agreements with Telecommunications Carriers	17	
Ancillary Services.....	8	
Application of Tariff.....	1	
Coin Services	15	
Contract Tariffs.....	19	
Exceptions to FIA Offerings	14	
General Regulations	2	
Miscellaneous Services	6	
Operating Territories of Frontier North Inc. and Concurring Telephone Companies	20	(N)
Ordering Options for FIA.....	3	
Primary Interexchange Carrier Charge (PICC)	12	
Rate Zone Wire Centers	18	
Special Access	5	
Special Construction.....	10	
Special Facilities Routing of FIA.....	9	
Special Federal Government FIA.....	11	

Applies to All Exchanges Illinois

FACILITIES FOR INTRASTATE ACCESS

TABLE OF CONTENTS
Alphabetical Listing

	<u>Section</u>
Specialized FIA or Arrangements	7
Switched Access	4
Video Digital Transport Service.....	17

Applies to All Exchanges Illinois

FACILITIES FOR INTRASTATE ACCESS

TABLE OF CONTENTS

1. APPLICATION OF TARIFF

2. GENERAL REGULATIONS

2.1 Undertaking of the Telephone Company

- 2.1.1 Scope
- 2.1.2 Limitations
- 2.1.3 Liability
- 2.1.4 Provision of FIA
- 2.1.5 Installation and Termination of FIA
- 2.1.6 Maintenance of FIA
- 2.1.7 Changes and Substitutions
- 2.1.8 Discontinuance and Refusal of FIA
- 2.1.9 Preemption of FIA
- 2.1.10 Limitation of Use of Metallic Facilities

2.2 Use

- 2.2.1 Interference or Impairment
- 2.2.2 Unlawful Use of FIA

2.3 Obligation of the Customer

- 2.3.1 Damages
- 2.3.2 Theft
- 2.3.3 Equipment Space and Power
- 2.3.4 Space and Power for Expanded Interconnection Service
- 2.3.5 Availability for Testing
- 2.3.6 Balance
- 2.3.7 Design of Customer Services
- 2.3.8 References to Telephone Company
- 2.3.9 Claims and Demands for Damages
- 2.3.10 Coordination With Respect to Network Contingencies
- 2.3.11 Identification and Rating of VoIP-PSTN Traffic

(N)

Applies to All Exchanges Illinois

FACILITIES FOR INTRASTATE ACCESS

TABLE OF CONTENTS

- 2. GENERAL REGULATIONS (Cont'd)
 - 2.4 Payment Arrangements and Credit Allowances
 - 2.4.1 Payment of Charges and Deposits
 - 2.4.2 Minimum Periods
 - 2.4.3 Cancellation of an ASR
 - 2.4.4 Credit Allowance for FIA Interruptions
 - (A) General
 - (B) When Credit Allowance Does Not Apply
 - (C) Use of an Alternative Service Provided by the Telephone Company
 - (D) Temporary Surrender of a FIA
 - 2.4.5 Performance Commitment Program
 - (A) Performance Commitment Program - Provisioning
 - (B) Performance Commitment Program - IC Desired Due Date for PIC Installation
 - 2.5 Connections
 - 2.5.1 General
 - 2.5.2 Standard Access Service Connections
 - 2.5.3 Expanded Interconnection - Fiber Optic
 - 2.5.4 Expanded Interconnection - Microwave
 - 2.6 Definitions
 - 2.7 FIA Services Provided By More Than One Telephone Company
 - 2.7.1 General
 - 2.7.2 Single Company Billing
 - 2.7.3 Meet Point Billing
 - 2.7.4 Zone Density Meet Point Billing

Applies to All Exchanges Illinois

FACILITIES FOR INTRASTATE ACCESS

TABLE OF CONTENTS

- 3. ORDERING OPTIONS FOR FIA
 - 3.1 General
 - 3.1.1 Ordering Conditions
 - 3.1.2 Provision of Other Service
 - 3.1.3 Special Construction
 - 3.1.4 Expanded Interconnection Service (EIS)
 - 3.1.5 Tandem Switch Signaling
 - 3.2 Access Service Request
 - 3.2.1 Service Date Intervals
 - 3.2.2 ASR Modifications
 - (A) Service Date Change Charge
 - (B) Partial Cancellation Charge
 - (C) Discontinuance of Service
 - (D) Design Change Charge
 - (E) Requests for Expedition
 - 3.2.3 Selection of Facilities for Access Service
 - 3.2.4 Minimum Period
 - 3.2.5 Minimum Period Charges
 - 3.2.6 Cancellation of an ASR
 - 3.2.7 Discontinuance of Switched Access FGD or BSA-D
 - 3.2.8 FGD or BSA - D Maximum Per Trunk Cancellation Charge
 - 3.3 Access Service Requests For Services Provided By More Than One Telephone Company

Applies to All Exchanges Illinois

FACILITIES FOR INTRASTATE ACCESS

TABLE OF CONTENTS

4. Switched Access

4.1 General

4.2 Rates and Charges—Frontier North Inc. (OCN 1015 Exchanges)

4.3 Rates and Charges—Frontier North Inc. (OCN 1036 Exchanges)

4.4 Rates and Charges—Frontier Communications of the Carolinas (OCN 1000 Exchanges)

(D)(N)

(N)

(D)

Applies to All Exchanges Illinois

FACILITIES FOR INTRASTATE ACCESS

TABLE OF CONTENTS

4. RESERVED FOR FUTURE USE (Cont'd)

(D)

(D)

Applies to All Exchanges Illinois

FACILITIES FOR INTRASTATE ACCESS

TABLE OF CONTENTS

4. RESERVED FOR FUTURE USE (Cont'd)

(D)

(D)

Applies to All Exchanges Illinois

FACILITIES FOR INTRASTATE ACCESS

TABLE OF CONTENTS

4. RESERVED FOR FUTURE USE (Cont'd)

(D)

(D)

Applies to All Exchanges Illinois

FACILITIES FOR INTRASTATE ACCESS

TABLE OF CONTENTS

4. RESERVED FOR FUTURE USE (Cont'd)

(D)

(D)

Applies to All Exchanges Illinois

FACILITIES FOR INTRASTATE ACCESS

TABLE OF CONTENTS

4. RESERVED FOR FUTURE USE (Cont'd)

(D)

(D)

Applies to All Exchanges Illinois

FACILITIES FOR INTRASTATE ACCESS

TABLE OF CONTENTS

4. RESERVED FOR FUTURE USE (Cont'd)

(D)

(D)

Applies to All Exchanges Illinois

FACILITIES FOR INTRASTATE ACCESS

TABLE OF CONTENTS

4. RESERVED FOR FUTURE USE (Cont'd)

(D)

(D)

Applies to All Exchanges Illinois

FACILITIES FOR INTRASTATE ACCESS

TABLE OF CONTENTS

5. SPECIAL ACCESS

5.1 General

5.1.1 Rate Elements

- (A) Special Transport
- (B) Special Access Line (SAL)
- (C) Special Access Cross Connect
- (D) Supplemental Features
- (E) Multiplexing Arrangements
- (F) Special Transport Termination

5.1.2 Special Access Configurations

- (A) Two-Point Service
- (B) Multipoint Service

5.1.3 Special Facilities Routing

5.1.4 Design Layout Report

5.1.5 Acceptance Testing

5.1.6 Ordering Conditions

- (A) Determination of Jurisdiction of Mixed Use Special Access Lines
- (B) Special Access Jurisdictional Verification
- (C)

5.2 Description of Special Access

5.2.1 Voiceband

- (A) Two-Wire Voiceband Facility
- (B) Four-Wire Voiceband Facility

5.2.2 Program Audio

- (A) 200 to 3500 Hz
- (B) 100 to 5000 Hz
- (C) 50 to 8000 Hz
- (D) 50 to 15000 Hz

Applies to All Exchanges Illinois

FACILITIES FOR INTRASTATE ACCESS

TABLE OF CONTENTS

5. SPECIAL ACCESS (Cont'd)

5.2 Description of Special Access

5.2.3 Videoband

(A) Videoband Services - Type I

5.2.4 Wideband Analog

5.2.5 Wideband Data Service

5.2.6 High Capacity Digital

5.2.7 Digital Data Service

5.2.8 Miscellaneous Special Access Services

5.3 Description of Terminating Options

5.3.1 Narrowband

(A) 0 to 75 Baud Type 1

(B) 0 to 75 Baud Type 2

(C) 0 to 150 Baud

5.3.2 Voice Grade

(A) Two-Wire Voice Grade, Non-Data, Without Signaling

(B) Four-Wire Voice Grade, Non-Data, Without Signaling

(C) Voice Grade Data Termination

(D) Two-Wire Voice Grade Station Connecting Facility
Termination

(E) Four-Wire Voice Grade Station Connecting Facility
Termination

(F) Two-Wire Station Connecting Facility Termination for
the Open End of an Off Premises PBX Extension

(G) Dial Repeating Tie Trunk Termination

5.3.3 Program Audio

(A) 200 to 3500 Hz

(B) 100 to 5000 Hz, 50 to 8000 Hz and 50 to 15000 Hz

5.3.4 Videoband

5.3.5 Wideband Data Service

Applies to All Exchanges Illinois

FACILITIES FOR INTRASTATE ACCESS

TABLE OF CONTENTS

5. SPECIAL ACCESS (Cont'd)

5.3 Description of Terminating Options (Cont'd)

5.3.6 High Capacity Digital

- (A) High Capacity Digital DS1
- (B) High Capacity Digital DS1C
- (C) Fractional T1 Service
- (D) FiberConnect Service
- (E) High Capacity Digital DS3
- (F) High Capacity Digital DS3C

5.3.7 Digital Data Service (DDS)

5.4 Description of Supplemental Features

5.4.1 Bridging

- (A) MultiPoint Data Bridging
- (B) Voice Conference Bridging
- (C) Alarm Distribution Bridging
- (D) Program Audio Bridging
- (E) DDS Bridging

5.4.2 Conditioning Arrangements - Data

- (A) Type C
- (B) Type DA

5.4.3 Conditioning - Program Audio

- (A) Stereo Conditioning
- (B) Zero Loss

5.4.4 Signaling Arrangements

5.4.5 Echo Control

- (A) Echo Suppression
- (B) Echo Canceller

5.4.6 Improved Return Loss

5.4.7 Voiceband Facility Switching Arrangement

5.4.8 Automatic Protection Switch

5.4.9 Improved Termination Option

5.4.10 Improved Equal Level Echo Path Loss Option - ELEPL-2

Applies to All Exchanges Illinois

FACILITIES FOR INTRASTATE ACCESS

TABLE OF CONTENTS

5. SPECIAL ACCESS (Cont'd)

5.5 Description of Multiplexing Arrangements

- (A) Group to Voice
- (B) Supergroup to Group
- (C) Mastergroup to Supergroup
- (D) DS1 to Voice
- (E) DS1C to Voice
- (F) DS1C to DS1
- (G) DS3 to DS1
- (H) DS3C to DS1
- (I) Group to DS1
- (J) Digital Data Carrier Multiplexer
- (K) Digital Data Subrate Multiplexer

5.6 Rate Regulations

5.6.1 Types of Rates and Charges

- (A) Monthly Rates
- (B) Daily Rates
- (C) Time Sensitive Rates
- (D) Zone Density Plan – Special Access
 - (E) Nonrecurring Charges
 - (1) Design Change Charge
 - (2) Installation of Supplemental Features and Multiplexing Arrangements
 - (3) Installation of FiberConnect, FT1, DS3 and DS Special Access Lines
 - (4) Installation of Temporary Videoband Service
 - (5) Installation of Voicegrade, Program Audio and Digital Data Service Special Access Lines
 - (6) Service Rearrangements

5.6.2 Minimum Periods

5.6.3 Mileage Measurement

5.6.4 Moves

- (A) Same CDL
- (B) Different CDL

Applies to All Exchanges Illinois

FACILITIES FOR INTRASTATE ACCESS

TABLE OF CONTENTS

- 5. SPECIAL ACCESS (Cont'd)
 - 5.6 Rate Regulations (Cont'd)
 - 5.6.5 Rates and Charges on an Individual Case Basis
 - 5.6.6 Hub Wire Centers
 - 5.6.7 Shared Use Analog and Digital High Capacity Services
 - 5.6.8 Temporary Videoband Service
 - (A) Type I
 - (1) Use of Permanent Facilities for Temporary Video Broadcast- Type 1
 - (2) Use of Nonpermanent Facilities for Temporary Video Broadcast - Type 1
 - (3) Use of Combined Facilities for Temporary Video Broadcast - Type 1
 - (4) Joint Provisioning of Service
 - 5.6.9 Special Access Surcharge
 - 5.6.10 Message Station Equipment Recovery Charge
 - 5.6.11 DS3 High Capacity Service
 - (A) DS3 Rate Structure
 - (B) Minimum Service Periods
 - (C) Expiration of Minimum Service Period
 - (D) Discontinuance Without Liability - DS3 Minimum Service Period
 - (E) Discontinuance With Liability - DS3 Minimum Service Period
 - (F) Notification of Discontinuance
 - (G) Upgrade to Higher Speed Service
 - (H) DS3 Multiplexer Cross Connect Arrangement
 - (I) Partitioned Billing Arrangement (PBA)
 - 5.6.12 Optional Payment Plan (OPP)
 - (A) General
 - (B) Changes in Length of OPP Period
 - (C) Renewal Options
 - (D) Notification of Discontinuance
 - (E) Upgrade to Higher Speed Service
 - (F) Termination Liability
 - (G) Termination without Liability
 - (H) OPP for FT1 Service
 - (I) OPP for DDS

Applies to All Exchanges Illinois

FACILITIES FOR INTRASTATE ACCESS

TABLE OF CONTENTS

5. SPECIAL ACCESS (Cont'd)

5.6 Rate Regulations (Cont'd)

5.6.13 Four-Wire Voiceband and Digital Data Service (DDS)

Rate Stability Plan (RSP)

- (A) Description
- (B) Eligibility Requirement
- (C) RSP Terms and Conditions
- (D) RSP Nonrecurring Charges
- (E) RSP Services
- (F) RSP Application
 - (1) Rate Elements Subject to the Plan
 - (2) RSP Expiration
 - (3) Upgrade to Higher Capacity Service

5.6.14 DS1 Term Volume Plan (TVP)

- (A) Description
- (B) Rate Application
- (C) Rate Changes
- (D) Threshold Levels
- (E) Changes to Commitment Quantity or Term
- (F) TVP Plan Enrollment
- (G) Annual Review
- (H) TVP Conditions
- (I) Penalties for Failing to Meet Commitment
- (J) TVP Nonrecurring Charge
- (K) Changes in Length of a TVP Period
- (L) Renewal Options
- (M) Upgrade to Higher Speed Service
- (N) Termination Liability
- (O) Termination without Liability

Applies to All Exchanges Illinois

FACILITIES FOR INTRASTATE ACCESS

TABLE OF CONTENTS

5. SPECIAL ACCESS (Cont'd)

5.7 Rates and Charges

5.7.1 Nonrecurring Charges

5.7.2 Voiceband Facilities

(A) Standard Arrangements

(B) Optional Arrangements

5.7.3 Program Audio Facilities

(A) Standard Arrangements 200-3500 Hz

(B) Standard Arrangements 100-5000 Hz

(C) Standard Arrangements 50-8000 Hz

(D) Standard Arrangements 50-15000 Hz

(E) Optional Arrangements (50-15000 Hz Facilities Only)

(F) Optional Arrangements (All Bandwidths)

5.7.4 Video Facilities

(A) Temporary Videoband Services Type I

5.7.5 Digital Data Service Facilities

(A) Standard Arrangements

(B) DDS Optional Payment Plan

(C) Optional Arrangements

5.7.6 Multiplexing Arrangements

5.7.7 High Capacity Digital DS1 (1.544 Mbps) Facilities

(A) Standard Arrangements

(B) Optional Arrangements

(C) DS1 Optional Payment Plan

Applies to All Exchanges Illinois

FACILITIES FOR INTRASTATE ACCESS

TABLE OF CONTENTS

- 5. SPECIAL ACCESS (Cont'd)
 - 5.7 Rates and Charges (Cont'd)
 - 5.7.8 High Capacity Digital FiberConnect (6.312 Mbps) Facilities
 - (A) FiberConnect Optional Payment Plan - Electrical Interface
 - (B) FiberConnect Optional Payment Plan - Optical Interface
 - 5.7.9 High Capacity Digital FT1 Facilities
 - (A) Standard Arrangement
 - (B) FT1 Optional Payment Plan
 - 5.7.10 High Capacity Digital DS3 (44.736 Mbps) Facilities - Three System
 - (A) Protected DS3
 - 5.7.11 High Capacity Digital DS3 (44.736 Mbps) Facilities-Unlimited System
 - (A) Protected DS3
 - 5.7.12 High Capacity Digital DS3 (44.736 Mbps) Facilities-Individual System
 - (A) Protected DS3 Individual
 - 5.7.13 High Capacity Digital DS3 (44.736 Mbps) Facilities - Group Systems*
 - (A) Protected DS3 x 12*
 - (B) Protected DS3 x 24*
 - 5.7.14 High Capacity Digital DS3 (44.736 Mbps) Facilities-Special Transport
 - 5.7.15 High Capacity Digital DS3 (44.736 Mbps) Facilities - Multiplexer
Cross Connect Arrangement
 - 5.7.16 Four-Wire Voiceband and Digital Data Service (DDS) Rate Stability Plan
(RSP)
 - (A) Rates
 - 5.7.17 DS1 Term Volume Plan (TVP)
 - 5.8 Miscellaneous Special Access Services
 - 5.8.1 Clear Channel Capability
 - (A) Description of Service
 - (B) Rates
 - 5.9 Special Access Cross Connect Rates and Charges

*Limited to those services so equipped and in service as of March 25, 1999.

Applies to All Exchanges Illinois

FACILITIES FOR INTRASTATE ACCESS

TABLE OF CONTENTS

- 6. MISCELLANEOUS SERVICES
 - 6.1 General
 - 6.2 Additional Labor
 - (A) Overtime Installation
 - (B) Overtime Repair
 - (C) Additional Installation Testing (ALH)
 - (D) Standby (ALT)
 - (E) Testing and Maintenance with Other Telephone Companies (ALK)
 - (F) Charges for Additional Labor (ALK)
 - 6.3 Maintenance of Service Charge
 - 6.4 Telecommunications Service Priority (TSP) System
 - (A) Description of the Service
 - (B) Obtaining TSP System Service
 - (C) Provisioning Priority
 - (D) Restoration Priority
 - (E) Obligations of the Customer
 - (F) Obligations of the Telephone Company
 - (G) Rates and Charges
 - 6.5 Balloting and Allocation Process For Equal Access
 - (A) IPIC Charge Application
 - (B) Unauthorized Primary IntraMSA Carrier (IPIC) Restoral Change
 - (C) Liabiliy of the Telephone Company
 - (D) Carrier Desired Due Date (ICDDD) for IPIC Installation
 - (E) Nonrecurring Charge for Primary IntraMSA Carrier (IPIC)
 - (F) IC CIC Consolidation
 - (G) Nonrecurring Charge for IC CIC Consolidation

Applies to All Exchanges Illinois

FACILITIES FOR INTRASTATE ACCESS

TABLE OF CONTENTS

6. MISCELLANEOUS SERVICES (Cont'd)

6.6 Additional Testing

- (A) Switched Access Testing
 - (1) Additional Cooperative Acceptance Testing
 - (2) Automatic Scheduled Testing
 - (3) Additional Cooperative Scheduled Testing
 - (4) Additional Manual Scheduled Testing
 - (5) Nonscheduled Testing
 - (6) Obligations of the Customer
- (B) Special Access Testing
 - (1) Additional Cooperative Acceptance Testing
 - (2) Nonscheduled Testing
 - (3) Obligation of the Customer
- (C) Rates and Charges
 - (1) Automatic Scheduled Testing
 - (2) Additional Cooperative Scheduled Testing
 - (3) Additional Manual Scheduled Testing

6.7 End User/Agent Lists

- (A) Presubscription List
- (B) Allocation Lists
- (C) Snapshot List
- (D) Line Range Reports - Lines Not Available for Subscription

6.7.1 Rates and Charges

- (A) Initial and Allocation Lists
- (B) Snapshot List
- (C) Line Rate Reports – (NRBZR)

Applies to All Exchanges Illinois

FACILITIES FOR INTRASTATE ACCESS

TABLE OF CONTENTS

- 6. MISCELLANEOUS SERVICES (Cont'd)
 - 6.8 Billing Name and Address Service
 - (A) Per Call/Periodic BNA and Data Gathering Service
 - (B) End User Validation List
 - 6.8.1 Rates and Charges
 - (A) Per Call/Periodic BNA
 - (B) Data Gathering Service
 - (C) End User Validation List
 - 6.9 Denial/Restoral Service
 - 6.10 International Blocking Service
 - 6.11 Service Access Code 900 Blocking
 - 6.12 Selective Class of Call Screening (SCOCS)
 - 6.13 Answer Supervision
 - 6.14 Reserved for Future Use (C)
 - 6.15 DS1 Span Power
- 7. SPECIALIZED FIA OR ARRANGEMENTS
 - 7.1 General

Applies to All Exchanges Illinois

FACILITIES FOR INTRASTATE ACCESS

TABLE OF CONTENTS

8. ANCILLARY SERVICES

8.1 Billing and Collection Services

8.1.1 Service Offerings

8.1.2 Regulations

8.1.3 Description of Billing and Collection Services

8.1.4 Rate Regulations

8.1.5 Rates and Charges

8.2 Directory Assistance Service

8.2.1 General

8.2.2 Description of Service

8.2.3 Undertaking of the Telephone Company

8.2.4 Obligations of the Customer

8.2.5 Payment Arrangements

8.2.6 Rate Regulations

8.2.7 Rates and Charges

8.3 Operator Services

8.3.1 General Description

8.3.2 Service Provisioning

8.3.3 Rate Regulations

8.3.4 Rates and Charges

Applies to All Exchanges Illinois

FACILITIES FOR INTRASTATE ACCESS

TABLE OF CONTENTS

9. SPECIAL FACILITIES ROUTING OF FIA

9.1 Description of Special Facilities Routing of FIA

9.1.1 Diversity

9.1.2 Avoidance

9.1.3 Cable-Only Facilities

9.2 Rates and Charges

9.2.1 Diversity

9.2.2 Avoidance

9.2.3 Diversity and Avoidance Combined

9.2.4 Cable-Only Facilities

10. SPECIAL CONSTRUCTION

10.1 General

10.1.1 Conditions Requiring Special Construction

10.1.2 Filing of Charges

10.1.3 Ownership of Facilities

10.1.4 Interval to Provide FIA

10.1.5 Special Construction Involving Interstate and Intrastate FIA

Applies to All Exchanges Illinois

FACILITIES FOR INTRASTATE ACCESS

TABLE OF CONTENTS

10. SPECIAL CONSTRUCTION (Cont'd)

10.2 Liabilities, Charges and Payments

10.2.1 General

10.2.2 Payment of Charges

10.2.3 Start/End of Billing

10.2.4 Partial Payments

10.2.5 Development of Liabilities and Charges

10.2.6 Types of Contingent Liabilities

(A) Maximum Termination Liability

(B) Reduction on Maximum Termination Liability

10.2.7 Types of Charge

(A) Nonrecurring Charges

(1) Case Preparation Charge

(2) Termination Charge

(3) Cancellation Charge

(4) Expediting Charge

(5) Optional Payment Charge

(a) Development of Optional Payment Charge

(b) Replacement Charge

(B) Recurring Charges

(1) General

(2) Excess Capacity Charge

(3) Charge for Route or Type Other Than Normal

(4) Lease Charge

Applies to All Exchanges Illinois

FACILITIES FOR INTRASTATE ACCESS

TABLE OF CONTENTS

10. SPECIAL CONSTRUCTION (Cont'd)

10.2 Liabilities, Charges and Payments

10.2.8 Application of Charges

(A) Special Construction of Permanent FIA

- (1) Special Construction When Not Available and There is No Other Requirement for Them
- (2) Special Construction Using a Route or Type of FIA Other Than Normal
- (3) Special Construction of a Greater Quantity of FIA Than Necessary to Satisfy the Customer's Order for Service
- (4) Special Construction Expedited at Greater Cost Than Would Otherwise be Incurred

(B) Special Construction of Temporary FIA Order

10.3 Deferral of the In-Service Date of FIA

10.3.1 General

10.3.2 Construction Has Not Started

10.3.3 Construction Has Started But is Not Complete

(A) All FIA Are Deferred

(B) Some But Not All FIA are Deferred

10.3.4 Construction Complete

10.4 Charges for Customers Choosing the Standard Liability Period to Provide Permanent FIA

Applies to All Exchanges Illinois

FACILITIES FOR INTRASTATE ACCESS

TABLE OF CONTENTS

- 11. SPECIAL FEDERAL GOVERNMENT FIA
 - 11.1 General
 - 11.2 Emergency Conditions
 - 11.3 Intervals to Provide FIA
 - 11.4 Safeguarding of FIA
 - 11.4.1 FIA Availability
 - 11.5 Federal Government Regulations
 - 11.6.1 Type and Description
 - (A) Voiceband Special Access
 - (1) Voice Grade Secure Communications Type I
 - (2) Voice Grade Secure Communications Type II
 - (3) Voice Grade Secure Communications Type III
 - (4) Voice Grade Secure Communications Type IV
 - (B) Special Wideband Digital Special Access
 - (1) Wideband Secure Communications Type I
 - (2) Wideband Secure Communications Type II
 - (3) Wideband Secure Communications Type III
 - (C) Federal Payment Plan (FPP) - DS1/DDS/Four-Wire Voiceband/DS3
 - (D) Switched Data Service
 - 11.6.2 Mileage Application
 - 11.6.3 Rates and Charges

Applies to All Exchanges Illinois

FACILITIES FOR INTRASTATE ACCESS

TABLE OF CONTENTS

12.	<u>PRIMARY INTEREXCHANGE CARRIER CHARGE (PICC)</u>	
12.1	<u>General</u>	
12.2	<u>Rates and Charges</u>	
13.	<u>VIDEO DIGITAL TRANSPORT SERVICE</u>	
13.1	<u>General</u>	
13.2	<u>Abbreviations</u>	
13.3	<u>Description</u>	
13.4	<u>Regulations</u>	
13.5	<u>General Rate Regulations</u>	
13.6	<u>Rates and Charges</u>	
14.	<u>EXCEPTIONS TO FIA OFFERINGS</u>	
15.	<u>RESERVED FOR FUTURE USE</u>	(T)
		(D)
		(D)

Applies to All Exchanges Illinois

FACILITIES FOR INTRASTATE ACCESS

TABLE OF CONTENTS

	(D)
	(D)
16. <u>ADVANCED COMMUNICATIONS NETWORKS</u>	
16.1 (A) <u>General</u>	
(B) <u>Generic Names</u>	
(C) <u>Administrative Changes</u>	
(D) <u>Moves</u>	
16.2 <u>Packet Switching Network Service</u>	
(A) <u>Service Description</u>	
(B) <u>Service Provisioning</u>	
(C) <u>Rate Regulations</u>	
(1) Minimum Period	
(2) Rate Application	
(D) <u>Supplemental Features</u>	
(1) Fast Select	
(2) Priority	
(E) <u>Rates and Charges</u>	
(1) X.75 Access	
(2) Logical Channels	
(3) Supplemental Features	

Applies to All Exchanges Illinois

FACILITIES FOR INTRASTATE ACCESS

TABLE OF CONTENTS

16. ADVANCED COMMUNICATIONS NETWORK (Cont'd)

16.3 Frame Relay Service – Grandfathered¹ (C)

- (A) Service Description
- (B) Service Provisioning
- (C) Obligations of the Company
- (D) Obligations of the Customer
- (E) Rate Regulations
- (F) Rates

17. AGREEMENTS WITH TELECOMMUNICATIONS CARRIERS PURSUANT TO SECTIONS 251 AND 252 OF THE FEDERAL TELECOMMUNICATIONS ACT OF 1996.

18. RATE ZONE WIRE CENTERS

19. CONTRACT SERVICES

a. OPERATING TERRITORIES OF FRONTIER NORTH INC. & CONCURRING TELEPHONE COMPANIES

20.1 Operating Territory of Frontier North Inc

(A) Operating Territory of Illinois – Concurs in Frontier Telephone Companies FCC No 5, Section 4, Terms and Conditions. (OCN 1015)

(B) Operating Territory of Illinois – Concurs in Frontier Telephone Companies FCC No. 5, Section 4, Terms and Conditions. (OCN 1015 - 1036)

¹ Effective May 31, 2022, Frontier will no longer support Moves, Adds or Changes nor new installations for [Frame Relay] Service. Upon service term expiration, this service will transition to a Month-to-Month service arrangement. (N)
|
(N)

Applies to All Exchanges Illinois

FACILITIES FOR INTRASTATE ACCESS

TABLE OF CONTENTS

20. OPERATING TERRITORIES OF FRONTIER NORTH INC. & CONCURRING
TELEPHONE COMPANIES (Cont'd)

20.2 Operating Territory of Frontier Communications of the Carolinas Inc.

(A) Operating Territory of Illinois – Concurs in Frontier Telephone Companies FCC
No. 5, Section 4, Terms and Conditions. (OCN - 1015) (OCN - 1000)

Applies to All Exchanges Illinois

FACILITIES FOR INTRASTATE ACCESS

CONCURRING CARRIERS

Frontier Communications of the Carolinas Inc. - Illinois

CONNECTING CARRIERS

No Connecting Carriers

OTHER PARTICIPATING CARRIERS

No Other Participating Carriers

EXPLANATION OF SYMBOLS

- (C) - To signify changed regulation
- (D) - To signify discontinued rate or regulation
- (I) - To signify increase
- (N) - To signify new rate or regulation
- (R) - To signify reduction
- (S) - To signify reissued matter
- (T) - To signify a change in text but no change in rate or regulation
- (M)- To signify a move of text (N)

EXPLANATION OF ABBREVIATIONS

- AAM - Assumed Access Minutes
- ac - alternating current
- ACAT - Additional Cooperative Acceptance Testing
- ACD - Automatic Call Distributer
- AIOD - Automatic Identification of Outward Dialed
- AM - Access Minutes
- ANI - Automatic Number Identification
- ARD - Automatic Ringdown
- ASG - Access Services Group
- ASR - Access Service Request
- AST - Automatic Scheduled Testing
- AT&TC - American Telephone and Telegraph Communications, Inc.
- BHMC - Busy Hour Minutes of Capacity
- BP - Billing Percentage
- BSA - Basic Serving Arrangement
- BSE - Basic Service Element
- CAC - Carrier Access Code

Applies to All Exchanges Illinois

FACILITIES FOR INTRASTATE ACCESS

EXPLANATION OF ABBREVIATIONS

CCS - Centum-Call Seconds
CCSA - Common Control Switching Arrangement(s)
CDL - Customer Designated Location
CDM - Call Days in Month
CFA - Connecting Facility Assignment
CIC - Carrier Identification Code
CIP - Carrier Identification Parameter
CMF - Chargeable Minimum Factor
COMPS - Central Office Maintenance Planning System
Cont'd - Continued
CST - Cooperative Scheduled Testing
CSU - Circuit Switching Unit
DA - Digital Data Access
DAM - Distance in Airline Miles
dB - Decibel
dBm - Decibels below one milliwatt
dBmO - Transmission Level Referred to the Zero Transmission Level Point
dBrnCO - Decibel Reference Noise C-Message Weighted O
dBv - Decibels Referred to One Volt
dc - direct current
DDS - Digital Data Service
DTMF - Dual Tone Multifrequency
DX - Duplex
ECCKT - Exchange Carrier Circuit ID
ELEPL - Equal Level Echo Path Loss
E&M - The Receive and Transmit Leads of a Signaling System
EML - Expected Measured Loss
EPL - Echo Path Loss
ERL - Echo Return Loss
f - frequency

Issued: May 10, 2011

Effective: July 1, 2011

By Kenneth Mason
Vice President
of Government and Regulatory Affairs

Applies to All Exchanges Illinois

FACILITIES FOR INTRASTATE ACCESS

EXPLANATION OF ABBREVIATIONS (Cont'd)

FCC - Federal Communications Commission
FCO - Foreign Central Office Service
FIA - Facilities for Intrastate Access
FNPA - Foreign Numbering Plan Area
FX - Foreign Exchange
GSEC - General Services and Equipment Code
HC - High Capacity
HNPA - Home Number Plan Area
Hz - Hertz
IA - Interface Arrangement
IC - Interexchange Carrier
ICB - Individual Case Basis
IDDD - International Direct Distance Dialing
ILP - Initial Liability Period
IP - Interconnection Point
kbps - kilobits per second
kHz - kilohertz
LEC - Local Exchange Carrier
Ma - Milliampere
Mbps - Megabits per second
MHz - Megahertz
MJU - Multi-Junction Unit
MRC - Monthly Recurring Charge
MSA - Market Service Area
MST - Manual Scheduled Testing
MTL - Maximum Termination Liability
NA - Not Available
NANP - North American Numbering Plan
NECA - National Exchange Carrier Association
NPA - Numbering Plan Area
NRC - Nonrecurring Charge
NST - Nonscheduled Testing
NXX - Three Digit Central Office Code

Applies to All Exchanges Illinois

FACILITIES FOR INTRASTATE ACCESS

EXPLANATION OF ABBREVIATIONS (Cont'd)

OCN – Operating Company Number
OPS - Off Premises Station
PBX - Private Branch Exchange
PCM - Pulse Code Modulation
POT - Point of Termination
RMC - Recurring Monthly Charge
rms - root-mean-square
SASG – Special Access Service Guarantee
SCFA - Secondary Connecting Facility Assignment
SF - Single Frequency
SRL - Singing Return Loss
STR - Switched Transport Rate
TDCF - Total Day Conversion Factor
TLP - Transmission Level Point
TV - Television
UL - Under Utilization Liability
VG - Voice Grade
V&H - Vertical & Horizontal
WA - Wideband Analog
WATS - Wide Area Telecommunications Service

(N)

Applies to All Exchanges Illinois

FACILITIES FOR INTRASTATE ACCESS

REFERENCE TO OTHER TARIFFS

Whenever reference is made in this tariff, the reference is to the tariffs in force as of the effective date of this tariff, and to amendments thereto and successive issues thereof.

REFERENCE TO TECHNICAL PUBLICATIONS

- (1) NECA Technical Reference Publication AS No. 1 - Issued March, 1984: entire issue
Addendum - Issued March, 1987
- (2) GTE Technical Interface Reference Manual, Issue 2 - Issued August, 1984, Revised December 1985, August 1986 and October 1988; Sections 3300, 5107, 6000, 6103 and 7000
- (5) American National Standards Institute Publication ANSI T1.102, Issued 1993
- (5) American National Standards Institute Publication ANSI T1.105, Issued 1995
- (5) American National Standards Institute Publication
For the Service Category of Frame Relay:
T1.602-1989, Issued 1988
T1.606-1990, Issued 1989
T1.617-1991, Issued 1991
T1.618-1991, Issued 1991
- (3) Underwriters Laboratory Publication UL 94, Issued 1990
- (1) AT&T Technical Reference Publication 41014 - Issued February, 1978; entire issue
- (2) GTE Service Corporation Telephone Operations - Traffic Grade of Service Standards, Issued April, 1985; entire issue.

Issued: May 10, 2011

Effective: July 1, 2011

By Kenneth Mason
Vice President
of Government and Regulatory Affairs

Applies to All Exchanges Illinois

FACILITIES FOR INTRASTATE ACCESS

REFERENCE TO TECHNICAL PUBLICATIONS (Cont'd)

- (4) Bellcore Technical Reference Publication
 - TR-TSV-000905, Issue 1, August, 1989 GR-253-CORE, Issue 2, April, 1996
 - TR-NWT-000499, Issue 4, November, 1991 GR-1400-CORE, Issue 1, March, 1994
 - TR-NWT-000063, Issue 4, July, 1991 GR-1374-CORE, Issue 1, March, 1994
 - TR-TSY-000191, Issue 1, May, 1986 GR-1149-CORE, Issue 1, October, 1995
 - TR-TSY-000487, Issue 1, July, 1989 Available February, 1997
 - TR-NPL-000320, Issue 1, April, 1988

- (4) Multiple Exchange Carrier Access Billing (MECAB) Guidelines - Issued June, 1994

- (4) Multiple Exchange Carrier Ordering and Design (MECOD) Guidelines - Issued May, 1994

REFERENCE TO NECA TARIFFS

- (1) NECA Tariff FCC No. 4
 - (1) Available from the Federal Communications Commission's commercial contractor.
 - (2) Available from Testmark Labs, 3050 Harrodsburg Rd., Lexington, Kentucky 40503
 - (3) Available from Underwriters Laboratory, Inc., Attention: Publications, 333 Pfingsten Rd., Northbrook, Illinois 60062.
 - (4) Available from Bellcore, Customer Service, 8 Corporate Place, Piscataway, New Jersey 08854-4196
 - (5) Available from American National Standards Institute, 1430 Broadway, New York, NY 10018.

Applies to All Exchanges Illinois

FACILITIES FOR INTRASTATE ACCESS

REFERENCE TO NECA TARIFFS (Cont'd)

(1) Section 6.4(E)(8) NCS Manual 3-1-1 "Telecommunications Service Priority (TSP) System for National Security Emergency Preparedness (NSEP) Service User Manual", dated July 9, 1990.

(1) Section 6.4(F)(4) NCS Handbook 3-1-2 "Telecommunications Service Priority (TSP) System for National Security Emergency Preparedness (NSEP) Service Vendor Handbook", dated July 9, 1990.

(1) 47 C.R.F. FCC Rules and Regulations, Part 15.109
Issued: May 26, 1999 10-01-95 Available: 10-01-95

(1) Available from Government Printing Office, Superintendent of Documentation, Document Control Branch, 941 North Capitol Street, N.E., Washington, DC 20401.

Issued: May 10, 2011

Effective: July 1, 2011

By Kenneth Mason
Vice President
of Government and Regulatory Affairs

Applies to All Exchanges Illinois

FACILITIES FOR INTRASTATE ACCESS

1. APPLICATION OF TARIFF

1.1 This tariff contains regulations, rates and charges applicable to Switched Access, Special Access, End User Access, Lifeline Assistance, Universal Service Fund, Advanced Communications Networks and Expanded Interconnection Service or, in combination, as Facilities for Intrastate Access, hereinafter referred to as FIA, provided by Frontier North Inc., hereinafter referred to as the Telephone Company to customers. This tariff further provides for Ancillary and Miscellaneous Services. This tariff does not apply to other services offered by the Telephone Company, nor is it applicable to Radio Common Carriers.

Pursuant to the Commission's Rules at Section 69.4(c), 69.5(d), 69.104(1), 69.116, 69.117, 69.603(c), and 69.603(d), regulations concerning administration and billing of Lifeline Assistance and Universal Service Fund, rates and charges for these carrier's carrier elements are contained in Section 8 of the National Exchange Carrier Association, Inc., Tariff FCC No. 5. The National Exchange Carrier Association, Inc., will bill and collect all Lifeline Assistance and Universal Service Fund charges on behalf of the Telephone Company.

- 1.2 Regulations, rates and charges as specified in this tariff apply to FIA and shall not serve as a substitute for IC tariff offerings of services to end users. The provision of such FIA by the Telephone Company as set forth in this tariff does not constitute a joint undertaking with an IC for the furnishing of any service.
- 1.3 Switched Access Service is provided from the premises of an end user to the premises of a carrier only for connection to facilities or services of the carrier, or from the premises of an end user to the premises of an end user only for direct connection to interMSA facilities.
- 1.4 The regulations and rates contained in Section 4 following (Switched Access), are not applicable to end users subscribing to FX services. Until such time as the application of switched access charges to FX end users is authorized by the Illinois Commerce Commission, FX end users will continue to be billed the appropriate individual line rate for the open end of the service.

Carrier FX services are fully subject to the provisions of 4. following (Switched Access) beginning May 25, 1984.

Applies to All Exchanges Illinois

FACILITIES FOR INTRASTATE ACCESS

SECTION 2 TABLE OF CONTENTS

2.	<u>GENERAL REGULATIONS</u>	<u>Page</u>	
2.1	<u>Undertaking of the Telephone Company</u>	3	
	2.1.1 Scope	3	
	2.1.2 Limitations	3	
	2.1.3 Liability	5	
	2.1.4 Provision of FIA	7	
	2.1.5 Installation and Termination of FIA.....	8	
	2.1.6 Maintenance of FIA	8	
	2.1.7 Changes and Substitutions.....	9	
	2.1.8 Discontinuance and Refusal of FIA	10	
	2.1.9 Preemption of FIA	11	
	2.1.10 Limitation of Use of Metallic Facilities	11	
2.2	<u>Use</u>	12	
	2.2.1 Interference or Impairment.....	12	
	2.2.2 Unlawful Use of FIA	13	
2.3	<u>Obligation of the Customer</u>	13	
	2.3.1 Damages.....	13	
	2.3.2 Theft	14	
	2.3.3 Equipment Space and Power.....	14	
	2.3.4 Space and Power for Expanded Interconnection Service	14	
	2.3.5 Availability for Testing.....	14	
	2.3.6 Balance.....	15	
	2.3.7 Design of Customer Services	15	
	2.3.8 References to Telephone Company	15	
	2.3.9 Claims and Demands for Damages	16	
	2.3.10 Coordination With Respect to Network Contingencies.....	16	
	2.3.11 Identification and Rating of VoIP-PSTN Traffic	16.1	(N)

Applies to All Exchanges Illinois

FACILITIES FOR INTRASTATE ACCESS

SECTION 2 TABLE OF CONTENTS

2.	<u>GENERAL REGULATIONS</u> (Cont'd)	<u>Page</u>
2.4	<u>Payment Arrangements and Credit Allowances</u>	17
2.4.1	Payment of Charges and Deposits	17
2.4.2	Minimum Periods	22
2.4.3	Cancellation of an ASR	22
2.4.4	Credit Allowance for FIA Interruptions.....	23
	(A) General.....	23
	(B) When Credit Allowance Does Not Apply	29
	(C) Use of an Alternative Service Provided by the Telephone Company	31
	(D) Temporary Surrender of a FIA.....	31
2.4.5	Performance Commitment Program	31
	(A) Performance Commitment Program - Provisioning.....	31
	(B) Performance Commitment Program - IC Desired Due Date for PIC Installation	33
2.5	<u>Connections</u>	33
2.5.1	General	33
2.5.2	Standard Access Service Connections	33
2.5.3	Expanded Interconnection (EIS) - Fiber Optic	34
2.5.4	Expanded Interconnection - Microwave	34
2.6	<u>Definitions</u>	35
2.7	<u>FIA Services Provided By More Than One Telephone Company</u>	66

Applies to All Exchanges Illinois

FACILITIES FOR INTRASTATE ACCESS

2. GENERAL REGULATIONS (Cont'd)

2.1 Undertaking of the Telephone Company

2.1.1 Scope

- (A) The Telephone Company does not undertake to transmit calls or offer a telecommunications service under this tariff.
- (B) The Telephone Company shall be responsible only for the installation, operation, and maintenance of the services which it provides.
- (C) The Telephone Company will, for maintenance purposes, test its FIA only to the extent necessary to detect and/or clear troubles. Testing beyond normal parameters will be done as described in Section 6.
- (D) FIA are provided twenty-four hours daily, seven days per week.

2.1.2 Limitations

- (A) The customer may not assign or transfer the use of FIA provided under this tariff except that, where there is no interruption of use or relocation of the FIA, such assignment or transfer may be made to:
 - another customer, whether an individual, partnership, association or corporation, provided the assignee or transferee assumes all outstanding indebtedness for such FIA, and the unexpired portion of the minimum period and the termination liability applicable to such FIA, if any; or
 - a court appointed receiver, trustee or other person acting pursuant to law in bankruptcy, receivership, reorganization, insolvency, liquidation or other similar proceedings, provided the assignee or transferee assumes the unexpired portion of the minimum period and the termination liability applicable to such FIA, if any.

Applies to All Exchanges Illinois

FACILITIES FOR INTRASTATE ACCESS

2. GENERAL REGULATIONS (Cont'd)

2.1 Undertaking of the Telephone Company

2.1.2 Limitations (Cont'd)

(A) (Cont'd)

In all cases of assignment or transfer, the written acknowledgment of the Telephone Company is required prior to such assignment or transfer which acknowledgment shall be made within 15 days from the receipt of notification. All regulations and conditions contained in this tariff shall apply to such assignee or transferee.

The assignment or transfer of FIA does not relieve or discharge the assignor or transferor from remaining jointly or severally liable with the assignee or transferee for any obligations existing at the time of the assignment or transfer.

(B) The emergency provisioning and restoration of FIA shall be in accordance FCC's Rules and Regulations, which specifies the priority system for such activities.

(C) The Telephone Company does not warrant that its facilities and services meet standards other than those set forth in this tariff.

Applies to All Exchanges Illinois

FACILITIES FOR INTRASTATE ACCESS

2. GENERAL REGULATIONS (Cont'd)

2.1 Undertaking of the Telephone Company (Cont'd)

2.1.3 Liability

- (A) The Telephone Company's liability, if any, for willful misconduct is not limited by this tariff. With respect to any other claim or suit by a customer for damages associated with the installation, provision, termination, maintenance, repair or restoration of FIA, and subject to the provisions of (B) through (D), the Telephone Company's liability, if any, shall not exceed an amount equal to the proportionate charge for the FIA for the period during which the provision of FIA was affected. This liability for damages shall be in addition to any amounts that may otherwise be due the customer under this tariff as a credit allowance for a provision of FIA interruption.
- (B) The Telephone Company shall not be liable for any act or omission of any other carrier or customer providing a portion of a service, nor shall the Telephone Company, for its own act or omission, hold liable any other carrier or customer providing a portion of a service.
- (C) The Telephone Company shall be indemnified, defended and held harmless by the customer against any claim, loss or damage arising from the use of FIA offered under this tariff. The foregoing indemnity shall issue on the customer separately, each being responsible for his own acts and omissions, involving:
- Claims for libel, slander, invasion of privacy, or infringement of copyright arising from any communications;
 - Claims for patent infringement arising from combining or using the FIA furnished by the Telephone Company in connection with facilities or equipment furnished by the customer; or
 - All other claims arising out of any act or omission of the customer in the course of using FIA provided pursuant to this tariff.

Issued: May 10, 2011

Effective: July 1, 2011

By Kenneth Mason
Vice President
of Government and Regulatory Affairs

Applies to All Exchanges Illinois

FACILITIES FOR INTRASTATE ACCESS

2. GENERAL REGULATIONS (Cont'd)

2.1 Undertaking of the Telephone Company (Cont'd)

2.1.3 Liability (Cont'd)

- (D) The Telephone Company does not guarantee or make any warranty with respect to its FIA when used in an explosive atmosphere. The Telephone Company shall be indemnified, defended and held harmless by the customer from any and all claims by any person relating to the FIA so provided. The foregoing indemnity shall issue on the customer separately, each being responsible for his own acts and omissions.
- (E) Except in the case of willful misconduct, under no circumstances, shall the Telephone Company be liable for indirect, incidental, special or consequential damages; and this disclaimer shall be effective notwithstanding any other provisions hereof.
- (F) No license under patents is granted by the Telephone Company to the customer or shall be implied or arise by estoppel in the customer's favor with respect to any circuit, apparatus, system or method used by the customer in connection with FIA provided under this tariff. With respect to claims of patent infringement made by third persons, the Telephone Company will defend, indemnify, protect and save harmless the customer from and against all claims arising out of the use by the customer of FIA provided under this tariff.

Applies to All Exchanges Illinois

FACILITIES FOR INTRASTATE ACCESS

2. GENERAL REGULATIONS (Cont'd)

2.1 Undertaking of the Telephone Company (Cont'd)

2.1.3 Liability (Cont'd)

(G) The Telephone Company's failure to provide or maintain FIA under this tariff shall be excused by labor difficulties, governmental orders, civil commotions, acts of God and other circumstances beyond the Telephone Company's reasonable control, subject to the interruption allowance provisions.

(H) The Telephone Company shall reimburse the customer for damages to premises or equipment of the customer resulting from the provision of FIA by the Telephone Company on such premises, or by the installation or removal thereof, caused by the negligence or willful act of the Telephone Company.

2.1.4 Provision of FIA

(A) The Telephone Company, to the extent that such FIA are or can be made available with reasonable effort, and after provisions have been made for the Telephone Company's local service, will provide to the customer, upon reasonable notice, FIA offered in other applicable sections of this tariff at rates and charges specified therein.

(B) FIA provided to a customer under this tariff may be connected directly to customer facilities and/or may be connected to access facilities of another telephone company or companies in the joint provision of intrastate access.

Issued: May 10, 2011

Effective: July 1, 2011

By Kenneth Mason
Vice President
of Government and Regulatory Affairs

Applies to All Exchanges Illinois

FACILITIES FOR INTRASTATE ACCESS

2. GENERAL REGULATIONS (Cont'd)

2.1 Undertaking of the Telephone Company (Cont'd)

2.1.5 Installation and Termination of FIA

Except as provided for Expanded Interconnection Service specified in this tariff, the FIA provided under this tariff (A) will include any entrance cable or drop wiring and wire or intrabuilding cable to that point where provision is made for termination of the Telephone Company's outside distribution network facilities at a suitable location inside a customer-designated location, and (B) will be installed by the Telephone Company to such point of termination.

2.1.6 Maintenance of FIA

(A) The FIA provided under this tariff shall be maintained by the Telephone Company. The customer or others may not rearrange, move, disconnect, remove or attempt to repair any FIA provided by the Telephone Company, other than by connection or disconnection to any interface means used, except with the written consent of the Telephone Company.

(B) Customer provided transmission facilities and equipment terminating in the Telephone Company wire center, access tandem, manhole or similar location for purposes of virtual Expanded Interconnection Service (EIS), will be maintained by the Telephone Company. Customer provided transmission facilities and equipment terminating in the Telephone Company wire center or access tandem for purposes of physical EIS will not be maintained by the Telephone Company.

Issued: May 10, 2011

Effective: July 1, 2011

By Kenneth Mason
Vice President
of Government and Regulatory Affairs

Applies to All Exchanges Illinois

FACILITIES FOR INTRASTATE ACCESS

2. GENERAL REGULATIONS (Cont'd)

2.1 Undertaking of the Telephone Company (Cont'd)

2.1.7 Changes and Substitutions

Except as provided for equipment and systems subject to FCC Rules and Regulations, the Telephone Company may, where such action is reasonably required in the operation of its business, substitute, change, or rearrange any telephone plant used in providing FIA under this tariff, change minimum network protection criteria, change operating or maintenance characteristics of facilities, or change operations or procedures of the Telephone Company. In case of any such substitution, change or rearrangement, the facility parameters will be within generally accepted standards. The Telephone Company shall not be responsible if any such substitution, change or rearrangement renders any customer furnished services obsolete or requires modification or alteration thereof or otherwise affects their use or performance. If such substitution, change or rearrangement materially affects the operating characteristics or technical parameters of the FIA, as originally ordered by the customer, the Telephone Company will notify the customer in writing prior to making such substitution, change or rearrangement. Notification will be given as follows:

- Should a major change occur, the Telephone Company shall notify the customer at least one year in advance. A major change is described as any change in telephone plant which will affect the technical parameters of the interface (e.g., level, impedance, signaling, interface, bandwidth, two-wire, four-wire, etc.)
- Should a minor change occur, the Telephone Company shall notify the customer as least thirty days in advance. A minor change is described as any change in telephone plant which will not affect the technical parameters of the interface (e.g., level, impedance, signaling, interface, bandwidth, two-wire, four-wire, etc.)

The Telephone Company will work cooperatively with the customer relative to the redesign and implementation required by the change in operating characteristics.

Applies to All Exchanges Illinois

FACILITIES FOR INTRASTATE ACCESS

2. GENERAL REGULATIONS (Cont'd)

2.1 Undertaking of the Telephone Company (Cont'd)

2.1.8 Discontinuance and Refusal of FIA

- (A) If the customer fails to comply with certain provisions including any payments to be made by him on the dates or at the times herein specified, and fails within thirty (30) days after written notice, by certified mail, from the Telephone Company to a person designated by the customer to correct such noncompliance, the Telephone Company may discontinue the provision of the FIA to the noncomplying customer. In case of such discontinuance, all applicable charges shall become due.
- (B) If the customer repeatedly fails to comply with the provisions of this tariff in connection with the provision of a FIA or group of FIA, and fails to correct such course of action after notice as in (A), the Telephone Company may refuse applications for additional FIA to the noncomplying customer until the course of action is corrected.
- (C) If the National Exchange Carrier Association, Inc., notifies the Telephone Company that the customer has failed to comply with the National Exchange Carrier Association, Inc., Tariff (Lifeline Assistance and Universal Service Fund charges) including any customer's failure to make payments on the date and times specified therein, the Telephone Company, may on thirty days' written notice to the customer by Certified U.S. Mail, take any of these actions:
- refuse additional applications for service.
 - refuse to complete any pending orders for service.
 - discontinue the provision of service to the customer.

In the case of discontinuance, all applicable charges including termination charges, shall become due.

Applies to All Exchanges Illinois

FACILITIES FOR INTRASTATE ACCESS

2. GENERAL REGULATIONS (Cont'd)

2.1 Undertaking of the Telephone Company (Cont'd)

2.1.9 Preemption of FIA

In certain instances, (i.e., when spare facilities and/or equipment are not available), it may be necessary to preempt existing services to provision or restore National Security Emergency Preparedness (NSEP) Services. If, in its best judgement, the Telephone Company deems it necessary to preempt, then the Telephone Company will ensure that:

- (A) A sufficient number of public switched services are available for public use if preemption of such services is necessary to provision or restore NSEP Service.
- (B) The service(s) preempted have a lower or do not contain NSEP assigned priority levels.
- (C) A reasonable effort is made to notify the preempted service customer of the action to be taken.
- (D) A credit allowance for any preempted service shall be made in accordance with the provisions in Section 2.4.4(A).

2.1.10 Limitation of Use of Metallic Facilities

Except for loop and duplex (DX) type signaling, metallic facilities shall not be used for ground return or split pair operation. Signals applied to the metallic facility shall conform to minimum protection criteria for direct electrical connections as in FCC Rules and Regulations. In the case of applications of dc telegraph signaling systems, the customer shall be responsible, at his expense, for the provision of current limitation devices to protect the Telephone Company FIA from excessive current due to abnormal conditions and for the provision of noise mitigation networks when required to reduce excess noise.

Applies to All Exchanges Illinois

FACILITIES FOR INTRASTATE ACCESS

2. GENERAL REGULATIONS (Cont'd)

2.1 Undertaking of the Telephone Company (Cont'd)

2.1.10 Limitation of Use of Metallic Facilities (Cont'd)

Interoffice metallic facilities are limited and requests for metallic facilities will only be provided where available. DC (Metallic) and telegraph-grade facilities and services will be discontinued effective May 30, 1992. Interoffice metallic facilities (wire pairs) are in diminishing supply, and can be expected to become less available as optical fiber is deployed and wire cables are removed.

2.2 Use

2.2.1 Interference or Impairment

- (A) The characteristics and methods of operation of any circuits, facilities or equipment provided by other than the Telephone Company, including customer transmission equipment and facilities used with EIS, and associated with the FIA provided under this tariff shall not interfere with or impair service over any facilities of the Telephone Company, its connecting and concurring carriers, or other telephone companies involved in its services, cause damage to their plant, impair the privacy of any communications carried over their facilities or create hazards to their employees or to the public.
- (B) Except as provided for equipment or systems subject to FCC Rules and Regulations, if such characteristics or methods of operation are not in accordance with (A), the Telephone Company will, where practicable, notify the customer, as appropriate, that temporary discontinuance of the use of FIA may be required; however, where prior notice is not practicable, nothing contained herein shall be deemed to preclude the Telephone Company's right to temporarily discontinue forthwith the use of FIA if such action is reasonable in the circumstances. In case of such temporary discontinuance the customer will be promptly notified and afforded the opportunity to correct the condition which gave rise to the temporary discontinuance. During such period of temporary discontinuance, allowance for interruption of FIA as in 2.4.4 is not applicable.

Issued: May 10, 2011

Effective: July 1, 2011

By Kenneth Mason
Vice President
of Government and Regulatory Affairs

Applies to All Exchanges Illinois

FACILITIES FOR INTRASTATE ACCESS

2. GENERAL REGULATIONS (Cont'd)

2.2 Use (Cont'd)

2.2.2 Unlawful Use of FIA

The FIA are furnished subject to the condition that they will not be used for an unlawful purpose. FIA will be discontinued if any law enforcement agency, acting within its apparent jurisdiction, advises in writing that such FIA are being used in violation of law. The Telephone Company will refuse to furnish FIA when it has reasonable grounds to believe that such FIA will be used in violation of law.

2.3 Obligation of the Customer

2.3.1 Damages

The customer shall reimburse the Telephone Company for damages to the Telephone Company facilities utilized to provide FIA under this Tariff caused by:

- the negligence or willful act of the customer, or
- resulting from the customer's improper use of the Telephone Company facilities, or
- due to malfunction of any facilities or equipment provided by other than the Telephone Company.

Nothing in the foregoing provision shall be interpreted to hold one customer liable for another customer's actions. The Telephone Company will, upon reimbursement for damages, cooperate with the customer in prosecuting a claim against the person causing such damage and the customer shall be subrogated to the right of recovery by the Telephone Company for the damages to the extent of such payment. The amount of reimbursement shall be the actual cost of repair to the damaged facilities including labor costs.

Applies to All Exchanges Illinois

FACILITIES FOR INTRASTATE ACCESS

2. GENERAL REGULATIONS (Cont'd)

2.3 Obligation of the Customer (Cont'd)

2.3.2 Theft

The customer shall reimburse the Telephone Company for any loss through theft of facilities, apparatus, or equipment utilized to provide FIA under this tariff at the customer designated location or at the end user's premises. The amount of reimbursement shall be the actual cost for replacement of facilities, apparatus, or equipment lost, plus labor costs.

2.3.3 Equipment Space and Power

The customer shall furnish or arrange to have furnished to the Telephone Company at no charge, equipment space and electrical power required by the Telephone Company to provide FIA under this tariff at the points of termination of such FIA. The equipment space provided shall meet industry standard environmental conditions. The selection of ac or dc power shall be mutually agreed to by the customer and the Telephone Company. The customer shall also make necessary arrangements in order that the Telephone Company will have access to such spaces at reasonable times for installing, repairing or removing facilities of the Telephone Company.

2.3.4 Space and Power for Expanded Interconnection Service

Where available, the Telephone Company shall make available wire center or access tandem floor space and electrical power required by the customer for the provision of Expanded Interconnection Service at charges set forth in this tariff.

2.3.5 Availability for Testing

The FIA provided under this tariff shall be available to the Telephone Company at times mutually agreed upon in order to permit the Telephone Company to make tests and adjustments appropriate for maintaining the FIA in satisfactory operating condition. Such tests and adjustments shall be completed within a reasonable time. No credit will be allowed for any interruptions involved during such tests and adjustments.

Applies to All Exchanges Illinois

FACILITIES FOR INTRASTATE ACCESS

2. GENERAL REGULATIONS (Cont'd)

2.3 Obligation of the Customer (Cont'd)

2.3.6 Balance

All signals for transmission over the FIA provided under this tariff shall be delivered by the customer balanced to ground except for ground start and duplex (DX), McCulloh-loop (alarm system) type signaling, and dc telegraph transmission at speeds of 75 baud or less.

2.3.7 Design of Customer Services

The customer shall be solely responsible at his expense for the overall design of his services. The customer shall be responsible separately, each at his own expense, for any redesigning or rearrangement of his services which may be required because of changes in FIA, operations or procedures of the Telephone Company, minimum network protection criteria or operating or maintenance characteristics of the FIA.

2.3.8 References to Telephone Company

The customer may advise his end users that certain FIA are provided by the Telephone Company in connection with the service the customer furnishes to his end user; however, the customer shall not represent that the Telephone Company jointly participates in the customer's services.

Applies to All Exchanges Illinois

FACILITIES FOR INTRASTATE ACCESS

2. GENERAL REGULATIONS (Cont'd)

2.3 Obligation of the Customer (Cont'd)

2.3.9 Claims and Demands for Damages

- (A) With respect to claims of patent infringement made by third persons, the customer shall defend, indemnify, protect and save harmless the Telephone Company from and against all claims arising out of the combining with, or use in connection with, the FIA provided under this tariff, any circuit, apparatus, system or method provided by the customer, the IC or his end users.
- (B) The customer shall defend, indemnify and save harmless the Telephone Company from and against suits, claims, and demands by third persons arising out of the construction, installation, operation, maintenance, or removal of the customer's circuits, facilities, or equipment connected to the Telephone Company's FIA provided under this tariff including, without limitation, Workmen's Compensation claims, actions for infringement of copyright and/or unauthorized use of program material, libel and slander actions based on the content of communications transmitted over the customer's circuits, facilities or equipment, and proceedings to recover taxes, fines, or penalties for failure of the customer to obtain or maintain in effect any necessary certificates, permits, licenses or other authority to acquire or operate the FIA provided under this tariff; provided, however, the foregoing indemnification shall not apply to suits, claims, and demands to recover damages for damage to property, death, or personal injury unless such suits, claims or demands are based on the tortuous conduct of the customer, his officers, agents or employees.

2.3.10 Coordination With Respect to Network Contingencies

The customer shall, in cooperation with the Telephone Company, coordinate in planning the actions to be taken to maintain maximum network capability following natural or man-made disasters which affect telecommunications services.

Applies to All Exchanges Illinois

FACILITIES FOR INTRASTATE ACCESS

2. GENERAL REGULATIONS (Cont'd)

2.3 Obligation of the Customer (Cont'd)

2.3.11 Identification and Rating of VoIP-PSTN Traffic

(A) Scope

- (1) VoIP-PSTN Traffic is defined as traffic exchanged between the Telephone Company end user and the customer in time division multiplexing ("TDM") format that originates and/or terminates in Internet protocol ("IP") format. This section governs the identification of VoIP-PSTN Traffic that is required to be compensated at interstate access rates by the Federal Communications Commission in its Report and Order in WC Docket Nos. 10-90, etc., FCC Release No. 11-161 (Nov. 18, 2011) ("FCC Order"). Specifically, this section establishes the method of separating such traffic (referred to in this tariff as "Relevant VoIP-PSTN Traffic") from the customer's traditional intrastate access traffic, so that such Relevant VoIP-PSTN Traffic can be billed in accordance with the FCC Order.
- (2) This section will be applied to the billing of switched access charges to a customer that is a local exchange carrier only to the extent that the customer has also implemented billing of interstate access charges for Relevant VoIP-PSTN Traffic in accordance with the FCC Order.

Applies to All Exchanges Illinois

FACILITIES FOR INTRASTATE ACCESS

2. GENERAL REGULATIONS (Cont'd)

2.3 Obligation of the Customer (Cont'd)

2.3.11 Identification and Rating of VoIP-PSTN Traffic (Cont'd)

(B) Rating of VoIP-PSTN Traffic

The Relevant VoIP-PSTN Traffic identified in accordance with this tariff section will be billed at rates equal to the Telephone Company's applicable tariffed interstate switched access rates as specified within this tariff.

As of July 13,2012, any intrastate originating Toll VOIP-PSTN Traffic will be billed at rates equal to the Company's intrastate originating switched access rates as provided in this tariff. Beginning July 1,2014, any intrastate originating Toll VOIP-PSTN Traffic identified in accordance with this tariff section will be billed at rates equal to the Telephone Company's relevant interstate switched access rates as provided in the Telephone Company's applicable Federal Access Tariff.

(N)
(N)

(C) Calculation and Application of Percent-VoIP-Usage Factor

The Telephone Company will determine the number of Relevant VoIP-PSTN Traffic minutes of use ("MOU") to which interstate rates will be applied under subsection (B), above, by applying a Percent VoIP Usage ("PVU") factor to the total intrastate access MOU exchanges with The Telephone Company from the customer. The PVU will be derived and applied as follows:

(D)
(T)

- (1) The customer will calculate and furnish to the Telephone Company a factor (the "PVU") representing the percentage of the total intrastate and interstate access MOU that the customer exchanges with the Telephone Company in the State, that is sent to the Telephone Company and that originated in IP format, or is received from the Telephone company and terminated in IP format. This PVU shall be based on information such as traffic studies, actual call detail, or other relevant and verifiable information.

(T)
(N)
(N)

FACILITIES FOR INTRASTATE ACCESS

2. GENERAL REGULATIONS (Cont'd)

2.3 Obligation of the Customer (Cont'd)

2.3.11 Identification and Rating of VoIP-PSTN Traffic (Cont'd)

(C) Calculation and Application of Percent-VoIP-Usage Factor (Cont'd)

- (2) The Telephone Company will, likewise, calculate a factor (the "PVU-T") representing the percentage of the Telephone Company's total intrastate access MOU in the State that the Telephone Company originates or terminates on its network in IP format. This PVU-T shall be based on information, such as the number of the Telephone Company's retail VoIP subscriptions in the state, traffic studies, actual call detail, or other relevant and verifiable information. (N)
- (3) The Telephone Company will use the PVU-C and PVU-T factors to calculate a PVU factor that represents the percentage of total intrastate MOU exchanged between a Telephone Company end user and the customer that is originated or terminated in IP format, whether at the Telephone Company's end, at the customer's end, or at both ends. The PVU factor will be calculated as the sum of: (A) the PVU-C factor and (B) the PVU-T factor times (1.0 minus the PVU-C factor). (N)
- (4) The Telephone Company will apply the PVU factor to the total terminating intrastate access MOU received from the customer to determine the number of Relevant VoIP-PSTN Traffic MOUs. (T)
- (5) If the customer does not furnish the Telephone Company with a PVU pursuant to the preceding paragraph 1, the Telephone Company will utilize a PVU equal to zero. (T)

Applies to All Exchanges Illinois

FACILITIES FOR INTRASTATE ACCESS

2. GENERAL REGULATIONS (Cont'd)

2.3 Obligation of the Customer (Cont'd)

2.3.11 Identification and Rating of VoIP-PSTN Traffic (Cont'd)

(D) Initial PVU Factor

If the PVU factor is not available and/or cannot be implemented in the Telephone Company's billing systems by January 30, 2012, once the factor is available and can be implemented the Telephone Company will adjust the customer's bills to reflect the PVU retroactively to January 30, 2012. This retroactive adjustment will be made to January 30, 2012, provided that the customer provides the factor to the Telephone Company no later than April 15, 2012; otherwise, it will set the initial PVU equal to zero, as specified in subsection (C)(1), above.

(M)

(M)

(E) PVU Factor Updates

The customer may update the PVU factor quarterly using the method set forth in subsection (C)(1), above. If the customer chooses to submit such updates, it shall forward to the Telephone Company, no later than 15 days after the first day of January, April, July and/or October of each year, a revised PVU factor based on data for the prior three months, ending the last day of December, March, June and September, respectively. The revised PVU factor will apply prospectively and serve as the basis for billing until superseded by a new PVU.

(F) PVU Factor Verification

Not more than four times in any year, the Telephone Company may ask the customer to verify the PVU factor furnished to the Telephone Company. The party so requested shall comply, and shall reasonably provide the records and other information used to determine the PVU factors.

Applies to All Exchanges Illinois

FACILITIES FOR INTRASTATE ACCESS

2. GENERAL REGULATIONS (Cont'd)

2.3 Obligation of the Customer (Cont'd)

2.3.11 Identification and Rating of VoIP-PSTN Traffic (Cont'd)

(G) Rates and Charges

Switched Access Rate Elements

Switched Access Rate Element	FCC 5 North & <u>Carolinas</u>	FCC 6 <u>North</u>	
Local Switching	*	*	(C) — (C)
Shared Trunk Port/Common Trunk Port	*	*	
Information Surcharge per MOU	*	*	
Tandem Transport Facility per minute-mile	*	*	
Tandem Transport Termination	*	*	
Tandem Switching	*	*	
Shared Multiplexing, per Tandem MOU	*	*	

* See Frontier Telephone Companies Tariff FCC No. 5 and 6 for rates.

Applies to All Exchanges Illinois

FACILITIES FOR INTRASTATE ACCESS

2. GENERAL REGULATIONS (Cont'd)

2.3 Obligation of the Customer (Cont'd)

2.3.11 Identification and Rating of VoIP-PSTN Traffic (Cont'd)

(H) Traffic that originates in Illinois on the PSTN and terminates outside of Illinois as VoIP will be billed at switched access element rates in (G), above (i.e., interstate rates or, alternatively refer to the FCC tariff). Traffic that originates on the PSTN in Illinois and terminates in Illinois as VoIP will be billed at intrastate switched access element rates contained elsewhere in this tariff.

(N)
|
(N)

2.4 Payment Arrangements and Credit Allowances

2.4.1 Payment of Charges and Deposits

(A) The Telephone Company may, in order to safeguard its interests, require a customer, which has a proven history of late payments to the Telephone Company or does not have established credit, to make a deposit prior to or at any time after the provision of the FIA to the customer to be held by the Telephone Company as a guarantee of the payment of rates and charges. No such deposit will be required of a customer which is a successor of a company which has established credit and has no history of late payments to the Telephone Company.

A deposit may not exceed the actual or estimated rates and charges for the FIA for a two month period. The fact that a deposit has been made in no way relieves the customer from complying with the Telephone Company's regulations as to the prompt payment of bills.

At such time as the provision of the FIA to the customer is terminated, the amount of the deposit will be credited to the customer's account and any credit balance which may remain will be refunded. After the customer has established a one year prompt payment record, such a deposit will be refunded or credited to the customer account at any time prior to the termination of the provision of the FIA to the customer.

Applies to All Exchanges Illinois

FACILITIES FOR INTRASTATE ACCESS

2. GENERAL REGULATIONS (Cont'd)

2.4 Payment Arrangements and Credit Allowances

(M)

2.4.1 Payment of Charges and Deposits (Cont'd)

(A) (Cont'd)

In case of a cash deposit, for the period the deposit is held by the Telephone Company, the customer will receive simple annual interest at the percentage rate determined by the Illinois Commerce Commission.

(B) Where the provision of FIA requires facilities that meet any of the conditions specified in 10.1.1, Special Construction charges in this tariff will apply.

(M)

(C) The Telephone Company shall bill FIA services on a current basis for (a) all charges incurred, (b) applicable taxes, and (c) credits due the customer.

- Switched Access (except for the Entrance Facility, Direct-Trunked Transport and Multiplexing elements), Ancillary and Miscellaneous services shall be billed in arrears.

- Special Access, monthly EIS elements and Switched Access Entrance Facility, Direct-Trunked Transport and Multiplexing elements shall be billed in advance except for the charges and credits associated with the initial or final bills. The initial bill will also include charges for the actual period of service up to, but not including, the bill date. The unused portion of the FIA already billed will be credited on the final bill.

The customer will receive his bill in; 1) a paper format, 2) a paper format bill summary with a magnetic tape to provide the detailed information of the bill, 3) magnetic tape only, or 4) via electronic transmission. Such bills are due when rendered regardless of the media utilized. Adjustments for the quantities of FIA established or discontinued in any billing period beyond the minimum period in 2.4.2 will be prorated to the number of days based on a 30 day month. The Telephone Company will, upon request and if available, furnish such detailed information as may reasonably be required for verification of any bill.

Applies to All Exchanges Illinois

FACILITIES FOR INTRASTATE ACCESS

2. GENERAL REGULATIONS (Cont'd)

2.4 Payment Arrangements and Credit Allowances (Cont'd)

2.4.1 Payment of Charges and Deposits (Cont'd)

(D) All bills to the customer are due 31 days (payment date) after the bill date or by the next bill date (i.e., same date in the following month as the bill date), whichever is the shortest interval. In the event the customer does not remit payment in immediately available funds by the payment date, the FIA may be discontinued.

(1) If the entire amount billed is not received by the Telephone Company in immediately available funds by the payment date, an additional charge (late payment charge) equal to $1/365$ th of the percentage rate for deposit interest as that in 2.4.1(A) of the unpaid balance will be applied for each day or portion thereof that an outstanding balance remains.

If such payment date would cause payment to be due on a Saturday, Sunday or Holiday (i.e., New Year's Day, Independence Day, Labor Day, Thanksgiving Day, Christmas Day, the second Tuesday in November and a day when Washington's Birthday, Memorial Day or Columbus Day is legally observed), payment for such bills will be due from the customer as follows:

- If such payment date falls on a Saturday or on a Holiday which is observed on Tuesday, Wednesday, Thursday or Friday, the payment date shall be the last non-Holiday day preceding such Saturday or Holiday.
- If such payment date falls on a Sunday or on a Holiday which is observed on a Monday, the payment date shall be the first non-Holiday day following such Sunday or Holiday.

Issued: May 10, 2011

Effective: July 1, 2011

By Kenneth Mason
Vice President
of Government and Regulatory Affairs

Applies to All Exchanges Illinois

FACILITIES FOR INTRASTATE ACCESS

2. GENERAL REGULATIONS (Cont'd)

2.4 Payment Arrangements and Credit Allowances (Cont'd)

2.4.1 Payment of Charges and Deposits (Cont'd)

- (2) In the event of a billing dispute, the customer must submit a documented claim for the disputed amount.
- If the claim is received within 6 months of the payment due date, and the customer has paid the total billed amount, any interest credits due the customer upon resolution of the dispute shall be calculated from the date of overpayment.
 - If the claim is received more than 6 months from the payment due date, any interest credits due the customer upon resolution of the dispute shall be calculated from the later of the date the claim was received or the date of overpayment.

Issued: May 10, 2011

Effective: July 1, 2011

By Kenneth Mason
Vice President
of Government and Regulatory Affairs

Applies to All Exchanges Illinois

FACILITIES FOR INTRASTATE ACCESS

2. GENERAL REGULATIONS (Cont'd)

2.4 Payment Arrangements and Credit Allowances (Cont'd)

2.4.1 Payment of Charges and Deposits (Cont'd)

(D) (Cont'd)

(2) (Cont'd)

A credit will be granted to the customer for both the disputed amount paid and an amount equal to the percentage rate in (1).

The Telephone Company will assess or credit late payment charges on disputed amounts to the customer as follows:

- If resolved in favor of the Telephone Company and the customer has paid the disputed amount on or before the payment due date, no late payment charges will apply.
 - If resolved in favor of the Telephone Company and the customer has withheld the disputed amount, any payments withheld pending settlement of the dispute shall be subject to the late payment charge in (1).
 - If resolved in favor of the customer and the customer has withheld the disputed amount, the customer shall be credited for each month or portion thereof that the late payment charge in (1) may have been applied. In the event the customer has paid the late payment charge, a credit will be granted to the customer for both the late payment charge paid on disputed amount and an amount equal to the percentage rate in (1).
- (3) Late Payment Charges applicable to End User FIA are those in other Tariffs of the Telephone Company.

Applies to All Exchanges Illinois

FACILITIES FOR INTRASTATE ACCESS

2. GENERAL REGULATIONS (Cont'd)

2.4 Payment Arrangements and Credit Allowances (Cont'd)

2.4.2 Minimum Periods

- (A) The minimum periods for which FIA are provided and for which rates and charges are applicable are in this tariff.
- (B) The minimum periods for which FIA are provided and for which rates and charges are applicable for Specialized FIA or Arrangements provided on an Individual Case Basis, as in this tariff are established with the individual case filing.
- (C) For discontinuances of FIA with a one month minimum period, all applicable charges for the one month period will apply. In instances where the minimum period is greater than one month, however, the charge will be the lesser of the Telephone Company's non-recoverable costs less the net salvage value for the discontinued service of the minimum period charges.
- (D) The minimum periods for which Expanded Interconnection Services are provided and which rates and charges are applicable are in this tariff.

2.4.3 Cancellation of an ASR

Provisions for the cancellation of an ASR are in 3.2.6.

Applies to All Exchanges Illinois

FACILITIES FOR INTRASTATE ACCESS

2. GENERAL REGULATIONS (Cont'd)

2.4 Payment Arrangements and Credit Allowances (Cont'd)

2.4.4 Credit Allowance for FIA Interruptions

(A) General

A FIA is interrupted when it becomes unusable to the customer because of a failure of a component used to furnish FIA under this tariff, or when the service is preempted as a result of invoking NSEP Treatment or when the application of protective controls interrupt all transmission paths as set forth in 4.2.9 following. An interruption period starts when Telephone Company personnel become aware that the FIA is inoperative.

The credit allowance(s) for an interruption or for a series of interruptions will be computed based upon the billing method which applies to the service being credited. In no case will the credit allowance for service interruptions exceed the applicable charges for the billing period during which the interruption occurred.

A credit allowance for any FIA service will apply for the period specified as follows:

- (1) For Special Access services other than Program Audio, Videoband and Expanded Interconnection, and for Switched Access Entrance Facilities, Direct-Trunked Transport and Multiplexing services a credit allowance will be made for an interruption period of 30 minutes or more. The allowance will be calculated at the rate of 1/1440 of the monthly charge for the portion of the FIA affected, for each 30 minutes or major fraction thereof that the interruption continues. A major fraction is considered to be sixteen minutes or more beyond the 30 minute period.
- (2) For Program Audio and Videoband Special Access services, a credit allowance will be made for an interruption of 30 seconds or more. Two or more such interruptions occurring during a period of 5 consecutive minutes shall be considered as one interruption. The allowance will be calculated as follows:

Applies to All Exchanges Illinois

FACILITIES FOR INTRASTATE ACCESS

2. GENERAL REGULATIONS (Cont'd)

2.4 Payment Arrangements and Credit Allowances (Cont'd)

2.4.4 Credit Allowance for FIA Interruptions (Cont'd)

(A) General (Cont'd)

(2) (Cont'd)

- (a) For Program Audio Service provided at monthly rates, the credit will be at the rate of 1/8640 of the monthly service rate.
 - (b) For Program Audio Service provided at daily rates, the credit will be at the rate of 1/288 of the daily rate.
 - (c) For Temporary Videoband Service provided at hourly rates, the credit will be at 1/12 of the hourly rate.
- (3) Except as noted, all Special Access Services will be eligible for a credit allowance for each occurrence of a service interruption period greater than 30 minutes. The maximum credit allowance will be \$200.00 for each out of service condition within the Telephone Company's facilities and will not exceed the monthly charge for the interrupted service. The credit allowance will not be applied more than once per calendar month. This credit allowance is applicable in all jurisdictions. The credit allowance is in addition to the credit allowance in 2.4.4(A)(1) and 2.4.4(A)(2). A credit allowance will not be extended in accordance with conditions in 2.1.3(H) and 2.4.4(B) for repair of Telephone Company owned facilities.

Applies to All Exchanges Illinois

FACILITIES FOR INTRASTATE ACCESS

2. GENERAL REGULATIONS (Cont'd)

2.4 Payment Arrangements and Credit Allowances (Cont'd)

2.4.4 Credit Allowance for FIA Interruptions (Cont'd)

(A) General (Cont'd)

(3) (Cont'd)

The exceptions to this credit allowance are part-time Program Audio Service in 5.2.2, Videoband Services in 5.2.3, Miscellaneous Special Access Services in 5.8 and Individual Case Basis Services in this tariff.

* Section 2.4.4(A)(3) is not available for Special Access Services installed after July 1, 2006. The preceding sentence applies to both Special Access Services that are provided on a month-to-month basis and Special Access Services that are provided under a Discount Plan (as defined below).

For Special Access Services installed on or before July 1, 2006, Section 2.4.4(A)(3) will not be available as follows:

- (a) For Special Access Services provided on a month-to-month basis, after July 1, 2006.
- (b) For Special Access Services provided under a Discount Plan (as defined below), after the date of expiration, termination, or cancellation of the Discount Plan commitment period that is in effect on July 1, 2006.

As used in this note, "Discount Plan" means any tariff arrangement for the provision of Special Access Services other than on a month-to-month basis.

For any month for which a Special Access Service receives a credit allowance under Section 2.4.4(A)(3), that Special Access Service shall not receive a credit allowance under Section 2.4.4(A)(4).

Applies to All Exchanges Illinois

FACILITIES FOR INTRASTATE ACCESS

2. GENERAL REGULATIONS (Cont'd)

2.4 Payment Arrangements and Credit Allowances (Cont'd)

2.4.4 Credit Allowance for FIA Interruptions (Cont'd)

(A) General (Cont'd)

- (4) For certain Special Access services, a Special Access Service Guarantee (SASG) credit allowance will apply in the event that such services experience a service interruption of four or more consecutive hours except as specified in 2.4.4(B) following. The SASG credit allowance will apply to Voiceband, monthly Program Audio, Video Digital Transport Service, Digital Data Service (DDS), and High Capacity DS1 & DS3 Special Access services (collectively, Special Access Services).

If a Special Access Service is eligible for an SASG credit allowance, the Telephone Company shall provide the applicable credit amount as set forth in the table following. The Telephone Company shall bill customer the applicable monthly rate for the Special Access Service, and if customer is eligible to receive the SASG credit allowance, the customer shall receive the SASG credit in a later invoice. Except as stated in this tariff, the SASG credit allowance is in addition to any other credit allowances available under this Section 2.4.4. The maximum amount of all credit allowances available under this Section 2.4.4 for a Special Access Service for a given billing period shall not exceed the total applicable monthly charge paid by the customer for such Special Access Service. The monthly charge will consist of all applicable rate elements charged to the circuit experiencing the service interruption. The SASG credit allowance can only be applied once per month on a per circuit basis. For multi-point circuits, the SASG credit allowance will apply to each leg of the circuit that experiences a service interruption.

Applies to All Exchanges Illinois

FACILITIES FOR INTRASTATE ACCESS

2. GENERAL REGULATIONS (Cont'd)2.4 Payment Arrangements and Credit Allowances (Cont'd)2.4.4 Credit Allowance for FIA Interruptions (Cont'd)(A) General (Cont'd)

(4) (Cont'd)

The Special Access Service Guarantee (SASG) credit allowance, for each applicable service is listed below:

<u>Service</u>	<u>SASG (per circuit)</u>
Voiceband	\$ 20.00
Full-time Program Audio (provided at monthly rates)	
200 – 3500 Hz	10.00
100 – 5000 Hz	15.00
50 – 8000 Hz	20.00
50 – 15000 Hz	25.00
Video Digital Transport Service (monthly, 1-year, 2-year, 3-year & 5-year plans)	100.00
Digital Data Service	
2.4 kbps	40.00
4.8 kbps	45.00
9.6 kbps	50.00
19.2 kbps	55.00
56.0 kbps	60.00
64.0 kbps	65.00
High Capacity	
DS1	160.00
DS3	400.00

Issued: May 10, 2011

Effective: July 1, 2011

By Kenneth Mason
Vice President
of Government and Regulatory Affairs

Applies to All Exchanges Illinois

FACILITIES FOR INTRASTATE ACCESS

2. GENERAL REGULATIONS (Cont'd)

2.4 Payment Arrangements and Credit Allowances (Cont'd)

2.4.4 Credit Allowance for FIA Interruptions (Cont'd)

(A) General (Cont'd)

(5) For Switched Access service, billed using assumed minutes of use, a credit allowance will be made for an interruption of 24 hours or more. The credit allowance will be calculated at 1/30 of the assumed minutes of use charge for each 24 hours or major fraction thereof that the interruption continues. A major fraction is considered to be 13 hours. No credit will be given where Switched Access billing is based on actual usage.

(6) For Switched Access service interrupted by an NXX isolation, a credit will be given the billed customer of record utilizing the following formula:

$300 \text{ Minutes of Use} \times \text{the appropriate Switched Access rate} \times \text{the number of trunks out of service} = \text{the credit allowance.}$

NXX isolation is defined as a situation whereby a customer in an NPA-NXX is unable to originate a call to the carrier network and/or receive a call from the carrier network.

The credit will apply when an out of service condition of 30 minutes or more occurs within the Telephone Company's switched facilities. The credit allowance will not be applied more than once per calendar month. A credit allowance will not be extended in accordance with conditions in 2.1.3(H) and 2.4.4(B) for repair of Telephone Company owned facilities.

Applies to All Exchanges Illinois

FACILITIES FOR INTRASTATE ACCESS

2. GENERAL REGULATIONS (Cont'd)

2.4 Payment Arrangements and Credit Allowances (Cont'd)

2.4.4 Credit Allowance for FIA Interruptions (Cont'd)

(A) General (Cont'd)

- (7) Switched Access Service entrance Facilities, Direct-Trunked Transport and Multiplexing will be eligible for a credit allowance for each occurrence of a service interruption period greater than 30 minutes. The maximum credit allowance will be \$200.00 for each out of service condition within the Telephone Company's facilities. The Credit Allowance will not exceed the monthly charge for the interrupted service and will not be applicable more than once per calendar month. This credit allowance is applicable in all jurisdictions. A credit allowance will not be extended in accordance with conditions in 2.1.3(H) and 2.4.4(B) for repair of Telephone Company owned facilities.

(B) When Credit Allowance Does Not Apply

No credit allowance will be made for:

- (1) Interruptions caused by the negligence of the customer.
- (2) Interruptions of a FIA due to the failure of equipment or systems provided by the customer or others.
- (3) Interruptions of a FIA during any period in which the Telephone Company is not afforded access to the premises where the FIA is terminated.
- (4) Interruptions of a FIA during an agreed upon period when the customer has released a FIA to the Telephone Company for maintenance purposes, to make rearrangements, or for the implementation of an ASR for a change in the FIA. Should the maintenance, rearrangement, or ASR implementation interruption period extend beyond the agreed upon period, credit allowance will apply.

Applies to All Exchanges Illinois

FACILITIES FOR INTRASTATE ACCESS

2. GENERAL REGULATIONS (Cont'd)

2.4 Payment Arrangements and Credit Allowances (Cont'd)

2.4.4 Credit Allowance for FIA Interruptions (Cont'd)

(B) When Credit Allowance Does Not Apply (Cont'd)

No credit allowance will be made for: (Cont'd)

- (5) Interruptions of a FIA which continue because of the failure of the customer to authorize replacement of any element of Special Construction, as set forth in Section 10 following. The period for which no credit allowance is made begins on the seventh day after the Telephone Company's written notification to the customer of the need for such replacement and ends on the day after receipt of the customer's written authorization for such replacement.
- (6) Periods when the customer elects not to release the FIA for testing and/or repair and continues to use it on an impaired basis.
- (7) Periods when the Telephone Company must temporarily interrupt an EIS, as defined in this tariff, in order to prevent damage or disruption of the Telephone Company's network due to the customer's equipment.
- (8) An interruption or a group of interruptions, resulting from a common cause, for amounts less than one dollar.
- (9) For EIS elements specified in this tariff, no credit allowance will be made.

Issued: May 10, 2011

Effective: July 1, 2011

By Kenneth Mason
Vice President
of Government and Regulatory Affairs

Applies to All Exchanges Illinois

FACILITIES FOR INTRASTATE ACCESS

2. GENERAL REGULATIONS (Cont'd)

2.4 Payment Arrangements and Credit Allowances (Cont'd)

2.4.4 Credit Allowance for FIA Interruptions (Cont'd)

(C) Use of An Alternative Service Provided by the Telephone Company

Should the customer elect to use an alternative service provided by the Telephone Company during the period that a FIA is interrupted, the customer must pay the tariffed rates and charges for the alternative service used.

(D) Temporary Surrender of a FIA

In certain instances, the customer may be requested to surrender a FIA for purposes other than maintenance, testing or activity relating to an ASR. If the customer consents, or in the instance of preemption under NSEP Treatment as set forth in this tariff than a credit allowance will be granted. The credit allowance will be determined in accordance with 2.4.4(A) preceding.

2.4.5 Performance Commitment Program

All refunds under the Performance Commitment Program will be provided as a credit adjustment to the customer's bill.

(A) Performance Commitment Program - Provisioning

The Telephone Company assures that orders for FIA will be installed and available for customer use no later than the Service Date, Service Date Intervals. The failure of the Telephone Company to meet the service date of an ASR will result in the refund of all NRCs associated with that ASR. The Telephone Company's liability for failure to meet this commitment is limited to the refund of the NRCs for the ASR associated with the missed Service Date.

Applies to All Exchanges Illinois

FACILITIES FOR INTRASTATE ACCESS

2. GENERAL REGULATIONS (Cont'd)

2.4 Payment Arrangements and Credit Allowances (Cont'd)

2.4.5 Performance Commitment Program (Cont'd)

(A) Performance Commitment Program – Provisioning (Cont'd)

The Performance Commitment Program - Provisioning does not apply:

- (1) when failure to meet the Service Date occurs because of conditions or due to actions of the customer.
- (2) to Special Construction as provided in Section 10.
- (3) when the Telephone Company is not the Access Service Coordination Exchange Carrier (ASC-EC) and the Service Date is not met by the LEC acting as ASC-EC for its portion of the service. See diagram below for indication of when the NRC refund will apply:

	Frontier ASC-EC	Another LEC ASC-EC
Misses Date	Refund Applies	Refund Applies
Another LEC Misses	Refund Applies Date	Refund Does Not Apply

Applies to All Exchanges Illinois

FACILITIES FOR INTRASTATE ACCESS

2. GENERAL REGULATIONS (Cont'd)

2.4 Payment Arrangements and Credit Allowances (Cont'd)

2.4.5 Performance Commitment Program (Cont'd)

(A) Performance Commitment Program – Provisioning (Cont'd)

(4) to Expanded Interconnection Services as provided in this tariff.

(5) to the Expedited Due Date as provided in this tariff.

(B) Performance Commitment Program - IC Desired Due Date for PIC Installation

The Telephone Company assures that the IC Desired Due Date (ICDDD) for PIC Installation, as set forth in 6.5(D), will be provided as negotiated. The failure of the Telephone Company to meet the ICDDD will result in the refund, to the IC's end user/agent customer, of the Nonrecurring Charge for Primary Interexchange Carrier, as set forth in this Tariff.

2.5 Connections

2.5.1 General

Equipment and systems (i.e., terminal equipment, multiline terminating systems, and communications systems) may be connected with Switched and Special Access furnished by the Telephone Company where such connection is made in accordance with the provisions specified in the NECA Technical Reference Publication AS No. 1 and in 2.1 preceding.

2.5.2 Standard Access Service Connections

Access services are provided by means of wire, fiber optics, radio or any other suitable technology or a combination thereof. Special Access service connections are made directly or through a Telephone Company hub wire bridging or multiplexing functions are performed. These connections can either be analog or digital.

Applies to All Exchanges Illinois

FACILITIES FOR INTRASTATE ACCESS

2. GENERAL REGULATIONS (Cont'd)

2.5 Connections (Cont'd)

2.5.3 Expanded Interconnection Service (EIS) - Fiber Optic

Fiber Optic EIS provides a customer with space and associated requirements such as power and environmental conditioning within or near a Telephone Company Central Office to locate certain fiber optic facilities and equipment, and an interconnection with certain Telephone Company provided facilities.

EIS will provided subject to the regulations and rates and charges set forth within this tariff.

2.5.4 Expanded Interconnection Service (EIS) - Microwave

Microwave EIS provides a customer with space and associated requirements such as power and environmental conditioning within a Telephone Company wire center to locate certain microwave facilities and equipment, and a connection to certain Telephone Company provided facilities.

Customer-provided microwave facilities, equipment and support structures may be located in, on or above the exterior walls and roof of Telephone Company central offices. Such interconnection must be made in accordance with the provisions specified in 2.1. These interconnections will be provided subject to the regulations and rates and charges set forth in this tariff.

Applies to All Exchanges Illinois

FACILITIES FOR INTRASTATE ACCESS

2. GENERAL REGULATIONS (Cont'd)

2.6 Definitions

Certain terms used herein are defined as follows:

Access Area

The term "Access Area" denotes a specific calling area containing those customers served by one or more Central Offices associated with the various Switched Access provisions offered under this tariff. The size and configuration of the Access Area a customer obtains is dependent upon the Feature Group type and the specific characteristics of the Central Office or Access Tandem office to which the connection is made.

Access Code

The term "Access Code" applies to Switched Access Service. It denotes a uniform seven digit code dialed by an end user to access an Interexchange Carrier's facilities. The Carrier Access Code (CAC) has the form 101XXXX and the Carrier Identification Code (CIC) has the form 950-XXXX.

Access Group

The term "Access Group" denotes a grouping of lines or trunks used to establish a connection between switching systems. Each grouping of lines or trunks is traffic engineered as a unit with each of the individual members of the group having identical characteristics and being interchangeable with any other member of the group.

Issued: May 10, 2011

Effective: July 1, 2011

By Kenneth Mason
Vice President
of Government and Regulatory Affairs

Applies to All Exchanges Illinois

FACILITIES FOR INTRASTATE ACCESS

2. GENERAL REGULATIONS (Cont'd)

2.6 Definitions (Cont'd)

Access Minutes

The term "Access Minutes" denotes that usage of exchange facilities in intrastate or foreign service for the purpose of calculating chargeable usage. On the originating end of an intrastate or foreign call, usage is measured from the time the originating End User's call is delivered by the Telephone Company to and acknowledged as received by the customer's facilities connected with the originating exchange. On the terminating end of an intrastate or foreign call, usage is measured from the time the call is received by the End User in the terminating exchange. Timing of usage at both originating and terminating ends of an intrastate or foreign call shall terminate when the calling or called party disconnects, whichever event is recognized first in the originating and terminating end exchanges, as applicable. For the calculation of total minutes, seconds are totaled and converted to minutes before rounding occurs. Remainder seconds greater than 29 are rounded to a minute.

Access Service Request

The term "Access Service Request" (ASR) denotes a document (i.e., order) used by the Telephone Company to process a customer's request for Access Services as offered throughout this tariff.

Access Tandem

The term "Access Tandem" denotes a Telephone Company switching system that provides a traffic concentration and distribution function for inter-Market Service Area traffic originating from or terminating at end offices in the access area.

Agent

The term "Agent", as used in this tariff, is defined as that person or entity that the Telephone Company acknowledges as controlling decisions pertaining to instrument placement, subscription authority, and access or usage control of Public or Semipublic Pay Telephone Service or, that person or entity duly authorized to act in that capacity by the physical owner of the premises.

Applies to All Exchanges Illinois

FACILITIES FOR INTRASTATE ACCESS

2. GENERAL REGULATIONS (Cont'd)

2.6 Definitions (Cont'd)

Answer/Disconnect Supervision

The term "Answer/Disconnect Supervision" denotes the transmission of the switch trunk equipment supervisory signal (off-hook or on-hook) to the CDL for terminating calls to a Telephone Company end office as an indication that the called party has answered or disconnected.

Answer Message

The term "Answer Message" denotes an SS7 message sent in the backward direction to indicate that the call has been answered.

Attempt

The term "Attempt" denotes a call in the originating direction from an end user to a CDL which is completed (answered) or not completed (not answered) and a call in the terminating direction from a CDL to a customer which is completed (answered) or not completed (not answered).

Attenuation Distortion

The term "Attenuation Distortion" denotes the difference in loss at specified frequencies relative to the loss at 1004 Hz.

Balance (100-Type) Test Line

The term "Balance (100-Type) Test Line" denotes a standard feature of FGA, FGB, FGC, FGD, 800, 877, 888 Access Service, BSA-A, BSA-B, BSA-C and BSA-D and refers to the end office termination provided for balance and noise testing. The termination provides off-hook supervision to the calling end, and terminates the line or trunk in a resistive and capacitive arrangement which simulates the characteristic impedance of the end office.

Applies to All Exchanges Illinois

FACILITIES FOR INTRASTATE ACCESS

2. GENERAL REGULATIONS (Cont'd)

2.6 Definitions (Cont'd)

Basic Service Element

The term "Basic Service Element (BSE)" denotes an unbundled service option available only with Basic Serving Arrangements.

Basic Serving Arrangement

The term "Basic Serving Arrangement (BSA)" denotes a category of Switched Access Service differentiated by technical characteristics, e.g., line side versus trunk side connection at the Telephone Company's first point of switching.

BHMC

See Busy Hour Minutes of Capacity.

Billed Number Screening

The term "Billed Number Screening (BNS)" denotes the process of utilizing a line information data base to determine billing number acceptance for collect and third number calls and to perform public telephone line number checks to prevent the alternate billing of calls to public coin telephone lines.

Bit

The term "Bit" denotes the smallest unit of information in the binary system of notation.

Bridging

The term "Bridging" denotes the connection of one or more circuits in parallel with another circuit without interrupting the continuity of the first circuit.

Bridging Wire Center

The term "Bridging Wire Center" denotes the Telephone Company designated wire center in which bridging is accomplished.

Applies to All Exchanges Illinois

FACILITIES FOR INTRASTATE ACCESS

2. GENERAL REGULATIONS (Cont'd)

2.6 Definitions (Cont'd)

Business Day

The term "Business Day" denotes the times of day that a company is open for business. Generally, in the business community, these are 8:00 or 9:00 a.m. to 5:00 or 6:00 p.m., respectively with an hour for lunch, Monday through Friday, resulting in a standard forty (40) hour work week.

Busy Hour Minutes of Capacity

The term "Busy Hour Minutes of Capacity" (BHMC) denotes the trunk group usage load consisting of the average usage load for the busy season.

Busy Season

The term "Busy Season" denotes the four consecutive weeks of the calendar year having the highest daily busiest hour traffic load based on a five day week. Normally the five-day week consists of Monday through Friday. Where weekend traffic is greater than weekday traffic, one or both weekend days may be used as a substitute for a weekday as long as a consistent five-day week is maintained for the four consecutive weeks.

Byte

The term "Byte" denotes a sequence or group of eight bits that represent one character.

Carrier Identification Code

The term "Carrier Identification Code" (CIC) denotes the uniform access code associated with a specific Interexchange Carrier.

Carrier Identification Parameter

The term "Carrier Identification Parameter" (CIP) denotes a field in the SS7 Initial Address Message (IAM) that identifies and transmits CIC information in a forward direction to an IC customer.

Applies to All Exchanges Illinois

FACILITIES FOR INTRASTATE ACCESS

2. GENERAL REGULATIONS (Cont'd)

2.6 Definitions (Cont'd)

C-Conditioning

The term "C-Conditioning" denotes a Telephone Company special treatment of the transmission path in order to control attenuation and envelope delay distortion.

C-Message Noise

The term "C-Message Noise" denotes the frequency weighted average noise within an idle voice circuit. The frequency weighting, called C-message, is used to simulate the frequency characteristic of the 500-type telephone set and the hearing of the average subscriber.

C-Notched Noise

The term "C-Notched Noise" denotes the frequency weighted noise on a voice circuit with a holding tone, which is removed at the measuring end through a notch (very narrow band) filter.

CCS

The term "CCS" denotes a hundred-call seconds which is a standard unit of traffic load that is equal to 100 seconds of usage or capacity of a group of lines or trunks.

Call

The term "Call" denotes a communication including an off-hook signal and routing information initiated at the originating location and completed to a terminating location.

Cellular Mobile Carrier (CMC)

The term "Cellular Mobile Carrier (CMC)" denotes a Common Carrier authorized by the Federal Communications Commission to provide cellular mobile radio telecommunications services.

Applies to All Exchanges Illinois

FACILITIES FOR INTRASTATE ACCESS

2. GENERAL REGULATIONS (Cont'd)

2.6 Definitions (Cont'd)

Central Office

The term "Central Office" denotes a telephone company local switching system where telephone company local service subscriber station loops are terminated for purposes of interconnection to each other and to trunks.

Central Office Loop Around Test Line

The term "Central Office Loop Around Test Line" denotes equipment in the Telephone Company's end office which provides a means for making two-way transmission tests for Switched Access services. These transmission tests are normally for the measurement of level and noise tests. This arrangement has two terminations, each reached by means of a separate seven digit number.

Central Office Prefix

The term "Central Office Prefix" denotes the first three digits (NXX) of the telephone number assigned to a Telephone Company subscriber's local service.

Centralized Automatic Reporting on Trunks (CAROT) Testing

The term "Centralized Automatic Reporting on Trunks (CAROT) Testing" denotes a type of testing which includes the capacity for measuring the 1000 Hz loss, C-message weighted noise, C-notched noise, loss slope, and the provision of a balance termination.

Channelize

The term "Channelize" denotes the process of multiplexing-demultiplexing circuits using analog or digital techniques.

Circuit

The term "Circuit" denotes an electrical or photonic, in the case of fiber optic based transmission systems, communications path between two or more points of termination.

Applies to All Exchanges Illinois

FACILITIES FOR INTRASTATE ACCESS

2. GENERAL REGULATIONS (Cont'd)

2.6 Definitions (Cont'd)

Committed Information Rate (CIR)

The term "Committed Information Rate (CIR)" denotes the maximum information rate at which Customer traffic will be admitted to the Frame Relay network without being designated eligible for discard.

Common Channel Signaling System 7 Network (CCS7)

The term "Common Channel Signaling System 7 Network (CCS7)" denotes a dedicated out-of-band signaling network which utilizes Signaling System 7 (SS7) protocol to provide call handling and data base access services.

Common Line

The term "Common Line" denotes a line, trunk, coin line or other facility provided under other Company tariffs, terminated on a Central Office switch. A Common Line - Residence is a line or trunk provided under the residence regulations of other Company tariffs. A Common Line - Business is a line provided under the business regulations of other Company tariffs. A coin line is a line provided under the public and/or semipublic service regulations of other Company tariffs.

Communications System

The term "Communications System" denotes circuits and other facilities which are capable of communications between terminal equipment provided by other than the Telephone Company or Telephone Company stations.

Confirmed ASR

The term "Confirmed ASR" denotes a customer's ASR for a) Switched Access FIA which the Telephone Company has processed with the Engineering Department to confirm for the customer and the Telephone Company the availability of facilities and/or equipment and b) Special Access FIA for which the Telephone Company confirms to the customer that the established due date can be met. The date the ASR is confirmed, the standard service date interval commences.

Applies to All Exchanges Illinois

FACILITIES FOR INTRASTATE ACCESS

2. GENERAL REGULATIONS (Cont'd)

2.6 Definitions (Cont'd)

Confirming Design Layout Report Date

The term "Confirming Design Layout Report (CDLR) Date" identifies the date that the Telephone Company is scheduled to receive confirmation that the Design Layout Report provided by the Telephone Company for a confirmed ASR is acceptable.

Conventional Signaling

The term "Conventional Signaling" denotes the inter-machine signaling system which has been traditionally used in North America for the purpose of transmitting the called number's address digits from the originating end office to the switching machine which will terminate the call. In this system, all of the dialed digits are received by the originating switching machine, a path is selected, and the sequence of supervisory signals and outpulsed digits is initiated. No overlap outpulsing, ten-digit ANI, ANI information digits, or acknowledgement wink are included in this signaling sequence.

Customer

The term "Customer" denotes any individual, partnership, association, joint stock company, trust, corporation, or governmental entity or any other entity which subscribes to the services offered under this tariff.

Customer Designated Location

The term "Customer Designated Location" (CDL) denotes a location specified by the customer for the purpose of terminating FIA services. The Telephone Company must have access to the location to perform installation, testing, and maintenance functions. The customer may or may not have access to the location. CDLs include locations such as customer premises, end user premises, customer repeater stations, customer microwave towers, a Telephone Company's first point of switching, some other point where Telephone Company testing can occur, etc. A CDL may be designated by the customer for Switched Access, Special Access, or both in combination.

Applies to All Exchanges Illinois

FACILITIES FOR INTRASTATE ACCESS

2. GENERAL REGULATIONS (Cont'd)

2.6 Definitions (Cont'd)

Customer Designated Location (Cont'd)

Customer transmission facilities and equipment may be terminated in Telephone Company wire centers or access tandems under EIS arrangements, as defined in Section 17. Telephone Company Switched and Special Access Services may be interconnected to such customer equipment using the Cross Connect arrangement as described in Section 4.5.3 and 5.1.1(D), respectively.

D-Conditioning

The term "D-Conditioning" denotes a Telephone Company special treatment of the transmission path in order to control C-notched noise and intermodulation distortion.

Daily Busiest Hour

The term "Daily Busiest Hour" denotes the highest usage hour for each day with the reading taken on the clock hour or half hour. The clock hour or half hour selection varies from day to day, depending upon the usage measured. The Daily Busiest Hour is also known as the Bouncing Busy Hour.

Data Transmission (107-Type) Test Line

The term "Data Transmission (107-Type) Test Line" denotes an arrangement which provides for the connection to a signal source which provides test signals for one-way testing of data and voice transmission parameters.

Dual Tone Multifrequency Address Signaling

The term "Dual Tone Multifrequency (DTMF) Address Signaling" denotes a type of signaling that is an optional feature of FGA and BSA-A. It may be utilized when FGA or BSA-A is being used in the terminating direction. An office arranged for signaling would expect to receive address signals from the IC in the form of DTMF format.

Applies to All Exchanges Illinois

FACILITIES FOR INTRASTATE ACCESS

2. GENERAL REGULATIONS (Cont'd)

2.6 Definitions (Cont'd)

Echo Path Loss

The term "Echo Path Loss" denotes the measure of reflected signal at a four-wire interface without regard to the send and receive Transmission Level Point (TLP).

Echo Return Loss

The term "Echo Return Loss" denotes a frequency weighted measure of return loss over the middle of the voiceband (approximately 500 to 2500 Hz) where talker echo is most annoying.

End Office Switch

The term "End Office Switch" denotes a Telephone Company local switching system located in a wire center where Telephone Company local service subscriber station loops are terminated for purposes of originating and terminating traffic to or from a customer.

End User

The term "End User" means any customer of an intrastate or foreign telecommunications service that is not a carrier, except that a carrier, other than the Telephone Company, shall be deemed to be an "end user" to the extent that such carrier uses a telecommunications service for administrative purposes, and a person or entity that offers telecommunications services exclusively as a reseller shall be deemed to be an "end user" if all resale transmissions offered by such reseller originate on the premises of such reseller (e.g., hotels, motels and shared tenant services).

Engineering Review

The term "Engineering Review" denotes the examination of an ASR with a customer requested change to determine if a design change is required. It includes, but is not limited to, the review for possible change requirements in equipment, interfaces, circuit configurations, engineering records, and billing.

Issued: May 10, 2011

Effective: July 1, 2011

By Kenneth Mason
Vice President
of Government and Regulatory Affairs

Applies to All Exchanges Illinois

FACILITIES FOR INTRASTATE ACCESS

2. GENERAL REGULATIONS (Cont'd)

2.6 Definitions (Cont'd)

Entry Switch

See First Point of Switching.

Excess Capacity

The term "Excess Capacity" denotes a quantity of FIA requested by the customer which is greater than that which the Telephone Company would construct to fulfill the customer's ASR.

Exchange

The term "Exchange" denotes a unit generally smaller than a Market Service Area (MSA), established by the Telephone Company for the administration of communications service in a specified area which usually embraces a city, town or village and its environs. It consists of one or more central offices together with the associated facilities used in furnishing communications service within that area. One or more designated exchanges comprise a given MSA.

Exchange Access Signaling

The term "Exchange Access Signaling" denotes the signaling system used by equal access end offices to transmit originating information and address digits to the customer's premises and includes the means of verifying the receipt of these address digits. Features of this system include overlap outputting (in suitably equipped end offices), identification of the type of call, identification of the ten-digit telephone number of the calling party, and acknowledgement wink supervisory signals.

Existing Suitable Space

The term "Existing Suitable Space" denotes a space in which ac/dc power, heat and air conditioning, battery and generator back-up power, and other requirements necessary for provision of wire center or access tandem equipment currently exists.

Applies to All Exchanges Illinois

FACILITIES FOR INTRASTATE ACCESS

2. GENERAL REGULATIONS (Cont'd)

2.6 Definitions (Cont'd)

Exit Message

The term "Exit Message" denotes an SS7 message sent to an end office by the Telephone Company tandem switch to mark the connect time when the Telephone Company's tandem switch sends an Initial Address Message to a customer.

Extended Area Service

The term "Extended Area Service" (EAS) denotes an arrangement whereby a customer in one exchange can call a local number in another exchange that is part of the extended area without paying a toll charge.

Facility

The term facility denotes generically the various transmission media used for the transmission of telecommunications services. This includes, but is not limited to, cable (copper pair, coaxial, and fiber optic) and microwave radio equipment.

Firm Order Confirmation Date

The term "Firm Order Confirmation (FOC) Date" denotes the date that the Telephone Company will provide the schedule of dates for the provisioning activities associated with the customer's request for service.

First Point of Switching

The term "First Point of Switching" denotes either the first Telephone Company location at which switching occurs on the terminating path of a call proceeding from the CDL to the terminating end office or the last Telephone Company location at which switching occurs on the originating path of a call proceeding from the originating end office to the CDL.

Applies to All Exchanges Illinois

FACILITIES FOR INTRASTATE ACCESS

2. GENERAL REGULATIONS (Cont'd)2.6 Definitions (Cont'd)Flexible Automatic Number Identification (FLEX ANI)

The term "Flexible Automatic Number Identification" denotes an optional feature or Basic Service Element that provides additional values for the information indicator digits available with the ANI feature on originating calls. These additional digits identify the type of line that is originating the call for billing, screening and routing purposes.

Four-Wire to Two-Wire Conversion

The term "Four-Wire to Two-Wire Conversion" denotes an arrangement which converts a four-wire transmission path to a two-wire transmission path to allow a four-wire facility to terminate in a two-wire entity such as a Central Office switch trunk circuit or switching system.

Frame

The term "Frame" denotes a group of data bits, in a specific format, with a flag at either end to indicate the beginning and end of the frame. The defined format enables network equipment to recognize the meaning and purpose of specific bits.

Frame Relay Access Line – Grandfathered¹

(C)

The term "Frame Relay Access Line" denotes a facility which provides access to the Frame Relay Network connecting customer facilities at the network interface with a corresponding Frame Relay Port.

Frame Relay Port

The term "Frame Relay Port" denotes the physical entry points for access lines and the originating and terminating points for Permanent Virtual Circuits (PVCs). Ports include the electronic equipment used in connecting these service elements to the Frame Relay Network, and enable customers to allocate bandwidth to applications, as needed, at customer designated transmission speeds of either 56 Kbps or 1.544 Mbps.

¹ Effective May 31, 2022, Frontier will no longer support Moves, Adds or Changes nor new installations for [Frame Relay] Service. Upon service term expiration, this service will transition to a Month-to-Month service arrangement.

(N)

|

(N)

Applies to All Exchanges Illinois

FACILITIES FOR INTRASTATE ACCESS

2. GENERAL REGULATIONS (Cont'd)

2.6 Definitions (Cont'd)

Ground Start Supervisory Signaling

The term "Ground Start Supervisory Signaling" denotes a type of signaling which provides for the application of ground on the tip side at the point of termination (assuming no signaling conversion has been provided by the Telephone Company) as an initial seizure signal before the application of ringing in the originating direction (towards the customer from the end office).

Immediately Available Funds

The term "Immediately Available Funds" denotes a corporate or personal check drawn on a bank account and funds which are available for use by the receiving party on the same day on which they are received and includes U.S. Federal Reserve bank wire transfers, U.S. Federal reserve notes, (paper cash), U.S. Coins, U.S. Postal Money Orders and New York Certificates of Deposit.

Individual Case Basis

The term "Individual Case Basis" (ICB) denotes a condition where the regulations, if applicable, rates and charges for an offering under the provisions of this tariff are developed based on the circumstances in each case.

Information Service Provider

The term "Information Service Provider" denotes one who offers a capability for generating, acquiring, storing, transforming, processing, retrieving, utilizing, or making available information which may be conveyed via telecommunications, except that such service does not include (1) any use of any such capability for the management, control, or operation of a telecommunications system or the management of a telecommunications service, or (2) the provision of time, weather, and such other similar audio services that are offered by Frontier North Inc..

Applies to All Exchanges Illinois

FACILITIES FOR INTRASTATE ACCESS

2. GENERAL REGULATIONS (Cont'd)

2.6 Definitions (Cont'd)

Initial Address Message (IAM)

The term "Initial Address Message (IAM)" denotes an SS7 message sent in the forward direction to initiate trunk set up with the busying of an outgoing trunk which carries the information about that trunk along with other information relating to the routing and handling of the call to the next switch.

Installed Cost

The term "Installed Cost" denotes the total cost (estimated or actual) by the Telephone Company to provide facilities for the offered services.

Interconnection

The term "Interconnection" denotes the termination of a customer's basic transmission facilities, including optical terminating equipment and multiplexers at or near Telephone Company wire center or access tandem. Interconnection may be provided as either physical or virtual.

Interconnection Point

The term "Interconnection Point" denotes physical EIS arrangements as the point where the customer-owned cable facilities connect to the Telephone Company termination equipment. The interconnection point for virtual EIS arrangements is the demarcation between ownership of the cable facilities.

Interexchange Carrier (IC) or Interexchange Common Carrier

The terms "Interexchange Carrier" (IC) or "Interexchange Common Carrier" denote any individual, partnership, association, joint stock company, trust, governmental entity or corporation engaged for hire in intrastate or foreign communication by wire or radio, between two or more MSAs.

Applies to All Exchanges Illinois

FACILITIES FOR INTRASTATE ACCESS

2. GENERAL REGULATIONS (Cont'd)

2.6 Definitions (Cont'd)

Intermodulation Distortion

The term "Intermodulation Distortion" denotes a measure of the nonlinearity of a circuit. It is measured using four tones, and evaluating the ratios (in dBs) of the transmitted composite four-tone signal power to the second-order products of the tones (R2), and third-order products of the tones (R3).

Interstate Communications

The term "Interstate Communications" denotes both interstate and foreign communications.

Intrastate Communications

The term "Intrastate Communications" denotes any communications within the state subject to oversight by the Illinois Commerce Commission as provided by the laws of Illinois.

Kilosegment

The term "Kilosegment" denotes a unit of packet transmission defined as 64,000 bytes of data; one thousand segments.

Line

The term "Line" denotes a communications path connecting an end office switch with an end user's premises or a CDL for the provision for FGA or BSA-A.

Applies to All Exchanges Illinois

FACILITIES FOR INTRASTATE ACCESS

2. GENERAL REGULATIONS (Cont'd)

2.6 Definitions (Cont'd)

Line Group

The term "Line Group" denotes a grouping of lines which are traffic engineered as a unit for the establishment of connections between end office switches and customers in which all of the communications paths are interchangeable.

Line Side Connection

The term "Line Side Connection" denotes a connection of a transmission path to the line side of an end office system.

Logical Channel

The term "Logical Channel" denotes a communication channel which allows two-way simultaneous transmission of data packets through the network. No circuit capability is preassigned to a logical channel. Capacity is made available as the data is transmitted. Each virtual connection utilizes one logical channel.

Market Service Area

The term "Market Service Area" (MSA) denotes a geographic area for the provision and administration of communications service. It encompasses designated Access Areas which are grouped to serve common social, economic, and other purposes.

Maximum Burst Rate [B(e)]

The term "Maximum Burst Rate [B(e)]" denotes the maximum information rate at which Customer traffic will be admitted to the Frame Relay network. Traffic rates in excess of B(e) will be automatically discarded on ingress to the network.

Maximum Termination Liability

The term "Maximum Termination Liability" (MTL) denotes the maximum amount of money for which the customer is liable in the event all FIA ordered in a Special Construction case are discontinued before a specified period of time.

Applies to All Exchanges Illinois

FACILITIES FOR INTRASTATE ACCESS

2. GENERAL REGULATIONS (Cont'd)

2.6 Definitions (Cont'd)

Maximum Termination Liability Period

The term "Maximum Termination Liability Period" denotes the length of time the customer is liable for a termination charge in the event specially constructed FIA are terminated. The MTL period is equal to the average account life of the FIA provided.

Mid Link

The term "Mid Link" denotes the Special Transport facilities between Hub Wire Centers where the circuit is bridged and/or where switching devices, such as a loop transfer arrangement, are located.

Milliwatt (102-Type) Test Line

The term "Milliwatt (102-Type) Test Line" denotes an arrangement in an end office which provides a 1004 Hz tone at 0 dBm0 for one-way transmission measurements towards the CDL from the Telephone Company end office.

Mobile Telephone Switching Office (MTSO)

The term "Mobile Telephone Switching Office (MTSO)" denotes a Cellular Mobile Carrier (CMC) switching facility that is used to originate or terminate calls on the CMC network, or originate or terminate calls between the CMC and the public switched telephone network.

Multicarrier Access Area

The term "Multicarrier Access Area" denotes an EAS for FGA and BSA-A or an area for FGB and BSA-B where FIA Services are provided by more than one telephone company in which a customer obtains access to an entire EAS or FGB or BSA-B area by obtaining a FGA or BSA-A, or FGB or BSA-B, access tandem arrangement that connects its switch with the First Point of Switching of the Primary Exchange Carrier.

Applies to All Exchanges Illinois

FACILITIES FOR INTRASTATE ACCESS

2. GENERAL REGULATIONS (Cont'd)

2.6 Definitions (Cont'd)

National Security Emergency Preparedness (NSEP) Services

The term "National Security Emergency Preparedness (NSEP) Services" denotes telecommunications services which are used to maintain a state of readiness or to respond to and manage any event or crisis (local, national or international), which causes or could cause injury or harm to the population, damage to or loss of property, or degrades or threatens the NSEP posture of the United States.

Net Salvage

The term "Net Salvage" denotes the estimated scrap, sale, or trade-in value, less the estimated cost of removal. Cost of removal includes the costs of demolishing, tearing down, removing, or otherwise disposing of the material and any other applicable costs. Because the cost of removal may exceed salvage, facilities may have negative net salvage.

Network Address

The term "Network Address" denotes the alphanumeric character string used to specify the destination of each switched connection made within the network.

Network Channel Interface Code

The "Network Channel Interface" code (NCI) is an ordering code that provides an indication of the generic channel type. The NCI code provides the technical characteristics of the interface and describes the physical and electrical characteristics of the special access interface to the customer designated locations. A complete description and listing of these interface codes is specified in Section 6103 of the Technical Interface Reference Manual.

Non-Overlap Outpulsing

The term "Non-Overlap Outpulsing" is the feature of the exchange access signaling system which provides initiation of pulsing to the customer's premises after the calling subscriber has completed dialing an originating call.

Applies to All Exchanges Illinois

FACILITIES FOR INTRASTATE ACCESS

2. GENERAL REGULATIONS (Cont'd)

2.6 Definitions (Cont'd)

Nonrecoverable Cost

The term “Nonrecoverable Cost” denotes the cost of the specially constructed facilities for which the Telephone Company has no foreseeable use should the customer terminate service.

Nonsynchronous Test Line

The term “Nonsynchronous Test Line” denotes an arrangement in step-by-step end offices which provides operational tests which are not as complete as those provided by the synchronous test lines, but which can be made more rapidly.

North American Numbering Plan

The term “North American Numbering Plan” denotes a three-digit area or Numbering Plan Area (NPA) code and a seven-digit telephone number made up of a three-digit Central Office code (NXX) plus a four-digit station number (XXXX).

NSEP Treatment

The term “NSEP Treatment” denotes the provisioning of a telecommunications service before others based on the provisioning priority level assigned by the Executive Office of the President.

Octet

The term “Octet” denotes a group of eight binary digits operated upon as an entity.

Off-Hook

The term “Off-Hook” denotes the active condition of Switched Access or a Telephone Company local service line.

Applies to All Exchanges Illinois

FACILITIES FOR INTRASTATE ACCESS

2. GENERAL REGULATIONS (Cont'd)

2.6 Definitions (Cont'd)

On-Hook

The term "On-Hook" denotes the active condition of Switched Access or a Telephone Company local service line.

Open Circuit Test Line

The term "Open Circuit Test Line" denotes an arrangement in an end office which provides an ac open circuit termination of the trunk or line by means of an inductor of several Henries.

Order Interval

The term "Order Interval" denotes the interval between the Scheduled Issue Date and the Service Date.

Originating Direction

The term "Originating Direction" denotes the use of Switched Access for the origination of calls from an end user to a CDL.

Overlap Outpulsing

The term "Overlap Outpulsing" is the feature of the exchange access signaling system which permits initiation of pulsing to the customer's premises before the calling subscriber has completed dialing an originating call.

OZZ Code

The term "OZZ Code" denotes the service class routing code of a multifrequency (MF) call that indicates the interexchange carrier trunk group to which the traffic will be routed (e.g., 0+, 0-, 500, 900, etc.).

Applies to All Exchanges Illinois

FACILITIES FOR INTRASTATE ACCESS

2. GENERAL REGULATIONS (Cont'd)

2.6 Definitions (Cont'd)

Packet

The term "Packet" denotes a continuous sequence of binary digits of information which is switched through the network as an integral unit. The user data is divided into segments for billing purposes. The number of segments contained in a packet is dependent upon the packet size.

Packet Switch

The term "Packet Switch" denotes a central office based switch that establishes a virtual connection between two data network addresses for the transmission of discrete amounts of information.

Packet Switching Office

The term "Packet Switching Office" denotes the central office where the packet switching functions are performed and access to the packet network is accomplished.

Permanent Virtual Circuit (PVC)

The term "Permanent Virtual Circuit (PVC)" denotes a logical channel, defined in software, that establishes a path from one customer port to another.

Physical EIS

The term "Physical EIS" denotes an offering that enables customers to place equipment needed to terminate basic transmission facilities, including optical terminating equipment and multiplexers, within or upon the Telephone Company's wire center or access tandem buildings, use such equipment to connect customer's fiber optic systems or microwave radio transmission facilities (where reasonably feasible) with the local exchange carrier's equipment and facilities used to provide intrastate special access services.

Applies to All Exchanges Illinois

FACILITIES FOR INTRASTATE ACCESS

2. GENERAL REGULATIONS (Cont'd)

2.6 Definitions (Cont'd)

Plant Test Date

The term "Plant Test Date" denotes the date on which installation is completed and the Telephone Company to customer testing can begin.

Point of Termination

The term "Point of Termination" denotes the point of demarcation at a CDL or end user premises at which the Telephone Company's responsibility for the provision of FIA Service ends.

Premises

The term "Premises" denotes a building or buildings on continuous property (except Railroad Right-of-Way, etc.) not separated by a public highway.

Pre-service Testing

The term "Pre-service Testing" denotes tests performed on a FIA to assure standard transmission performance/parameters meet specifications prior to acceptance testing.

Primary Exchange Carrier

The term "Primary Exchange Carrier" (PEC) denotes the telephone company in whose exchange a customer's first point of switching (i.e., dial tone for FGA or BSA-A, an access tandem for FGB or BSA-B) is located.

Protocol

The term "Protocol" denotes a set of rules governing the format to be followed when transmitting information between communicating devices.

Applies to All Exchanges Illinois

FACILITIES FOR INTRASTATE ACCESS

2. GENERAL REGULATIONS (Cont'd)

2.6 Definitions (Cont'd)

Public Pay Telephone

The term "Public Pay Telephone" denotes a switched coin line provided under the Public Telephone Service regulations as set forth in other Tariffs of the Company.

Query

The term "Query" denotes a Signaling System 7 (SS7) message requesting specific information from a data base.

Recoverable Cost

The term "Recoverable Cost" denotes the cost of specially constructed facilities for which the Telephone Company has a foreseeable reuse, either in place or elsewhere should the customer terminate service.

Registered Equipment

The term "Registered Equipment" denotes the customer's terminal equipment which complies with or has been approved within the Registration Provisions of Part 68 of the FCC Rules and Regulations.

Release Message

The term "Release Message" denotes an SS7 Message sent in either direction to indicate that a specific circuit is being released.

Route Mileage

The term "Route Mileage" denotes the actual Telephone Company provided facility mileage of a transmission circuit.

Applies to All Exchanges Illinois

FACILITIES FOR INTRASTATE ACCESS

2. GENERAL REGULATIONS (Cont'd)

2.6 Definitions (Cont'd)

Scheduled Issue Date

The term "Scheduled Issue Date" denotes the date the Telephone Company is scheduled to issue the confirmed ASR to all associated work groups.

Secondary Exchange Carrier

The term "Secondary Exchange Carrier" (SEC) denotes the telephone company in whose exchange a customer does not subscribe to FGA or BSA-A, or FGB or BSA-B service, but from whose exchange the customer's end users can call the interexchange switch or CDL of an IC in the primary exchange of another telephone Company on a toll-free basis.

Segment

The term "Segment" denotes a unit of user information consisting of 64 octets or less. Billing for Packet Switching Network Service is based on the number of segments transmitted within the user data field of a packet. The number of segments transmitted within a packet is limited only by the subscribed or negotiated maximum size of the user data field for the customer interface.

Semipublic Pay Telephone

The term "Semipublic Pay Telephone" denotes a switched coin line provided under the Semipublic Telephone Service regulations as set forth in other Tariffs of the Company.

Applies to All Exchanges Illinois

FACILITIES FOR INTRASTATE ACCESS

2. GENERAL REGULATIONS (Cont'd)

2.6 Definitions (Cont'd)

Service Date

The term "Service Date" denotes the date that the FIA is to be placed in service. A confirmed ASR is required to establish a service date.

Serving Wire Center

The term "Serving Wire Center" denotes the wire center from which the customer designated location would normally obtain dial tone from the Telephone Company. The "Serving Wire Center" is designated by the Telephone Company based upon the location being served.

Seven-Digit Manual Test Line

The term "Seven-Digit Manual Test Line" denotes a set of optional features for all Switched Access which allow the IC to select balance, milliwatt, and synchronous test lines of FGA and BSA-A, by manually dialing a seven-digit number over the associated Switched Access.

Short Circuit Test Line

The term "Short Circuit Test Line" denotes the end office circuit which provides an ac short circuit termination of the trunk or line by means of a capacitor of at least 4 microfarads.

Signal Transfer Point

The term "Signal Transfer Point (STP)" denotes a packet switch which provides access to the Telephone Company's SS7 network and performs SS7 message signal routing and screening. The technical interface specifications, transmission specifications, and diversity requirements for interconnecting to the Telephone Company's SS7 network at the STP are as described in Bellcore Technical Reference Publication TR-TSV-000905.

Applies to All Exchanges Illinois

FACILITIES FOR INTRASTATE ACCESS

2. GENERAL REGULATIONS (Cont'd)

2.6 Definitions (Cont'd)

Signaling System 7 (SS7)

The term "Signaling System 7 (SS7)" denotes the layered protocol used for standardized common channel signaling in the United States.

Synchronous Test Line

The term "Synchronous Test Line" denotes an arrangement of an end office which performs marginal operational tests of supervisory and ring-tripping functions.

Telecommunications Service Priority (TSP) System

The term "Telecommunications Service Priority (TSP) System" or "TSP System" refers to the regulatory, administrative and operational system authorizing and providing for priority treatment (i.e., the provisioning and restoration) or NSEP Services.

Temporary Facilities

The term "Temporary Facilities" denotes facilities used to provide FIA to a customer for less than the minimum service period or less than one month, whichever is longer, or to provide FIA while permanent facilities are being constructed.

Terminating Direction

The term "Terminating Direction" denotes the use of Switched Access for the completion of calls from a CDL to an end user.

Trunk

The term "Trunk" denotes a communications path connecting two switching systems in a network, used in an end-to-end connection.

Applies to All Exchanges Illinois

FACILITIES FOR INTRASTATE ACCESS

2. GENERAL REGULATIONS (Cont'd)

2.6 Definitions (Cont'd)

Trunk Group

The term "Trunk Group" denotes a grouping of trunks which are traffic engineered as a unit for the establishment of connections between switching systems in which all of the communications paths are interchangeable.

Trunk Side Connection

The term "Trunk Side Connection" denotes the connection of a transmission path to the trunk side of an end office switch.

V & H Coordinates Method

The term "V & H Coordinates Method" denotes a method of computing airline miles between two points by utilizing an established formula which is based on the Vertical (V) and Horizontal (H) coordinates of the two points.

Virtual Connection

The term "Virtual Connection" denotes a logical channel resulting from call establishment to a network address that exists until the call is terminated by either party.

Virtual EIS

The term "Virtual EIS" denotes an offering that enables customers to designate or specify equipment needed to terminate basic transmission facilities, including optical terminating equipment and multiplexers, to be located within or upon Telephone Company's wire center or access tandem buildings, and dedicated to such customers use.

Applies to All Exchanges Illinois

FACILITIES FOR INTRASTATE ACCESS

2. GENERAL REGULATIONS (Cont'd)

2.6 Definitions (Cont'd)

WATS Access¹ - Grandfathered

(C)

The term "WATS Access" is an access service provided to customers for the purpose of enabling the provision of WATS. WATS Access is provided by the Telephone Company using a combination of the WATS Special Access Service surrogate billed to the end user as reflected in the WATS Access Line Charges set forth in other Tariffs of the Company, Switched Access Service and a WATS Switched Interface as offered within this tariff. The use of the Special Access surrogate in lieu of a common line at the closed end exempts traffic at the closed end from Carrier Common Line Charges.

WATS Serving Office¹ - Grandfathered

(C)

The term "WATS Serving Office" denotes a Telephone Company designated serving wire center where switching, screening and/or recording functions are performed in connection with a Special Access Line used with a Switching Interface as in 4.2.5(V).#

Wire Center

The term "Wire Center" denotes a location in which one or more central office switches, and cross connection equipment used for the provision of Telephone Company telecommunications services, are located.

Wire Center Area

The term "Wire Center Area" denotes the geographic area served by a Wire Center through the use of central office switching equipment, cross connection equipment, and subscriber loops.

The use of the terms WATS or WATS-type throughout this tariff is primarily for ordering purposes and is not intended to restrict the use of the customer services when ordering Special Access and Switched Access in combination.

¹ Wide Area Telecommunications Service (WATS) offering is grandfathered as of August 31, 2020 and limited to existing subscribers at their existing locations.

(N)

(N)

Applies to All Exchanges Illinois

FACILITIES FOR INTRASTATE ACCESS

2. GENERAL REGULATIONS (Cont'd)

2.6 Definitions (Cont'd)

X.25 Protocol

The term "X.25 Protocol" denotes an interface between Data Terminal Equipment and Data Circuit Terminating Equipment for terminals operating in the packet mode on public data networks.

X.75 Protocol

The term "X.75 Protocol" denotes terminal and transit call control procedures and data transfer system on circuits between packet switched data networks.

Applies to All Exchanges Illinois

FACILITIES FOR INTRASTATE ACCESS

2. GENERAL REGULATIONS (Cont'd)

2.7 FIA Services Provided By More Than One Telephone Company

2.7.1 General

When Switched Transport or Special Transport service is provided by more than one telephone company, the telephone companies involved will mutually agree upon one of the billing methods based upon the type of access service and the interconnection arrangements between the telephone companies.

The telephone company will notify the customer which billing method will be used.

2.7.2 Single Company Billing:

The Single Company Billing method may be applied to FGA and BSA-A Switched Access Service.

The telephone company receiving the ASR from the customer, as specified in 3.3(A)(1) following, will arrange to provide the service, determine the applicable charges and bill the customer for the entire service in accordance with its Access tariff. The airline mileage is determined using the V&H method as in the Exchange Carrier Association (NECA) Tariff FCC No. 4.

2.7.3 Meet Point Billing:

Meet Point Billing is required when an access service is provided by multiple Telephone Companies for FGB, FGC, FGD, BSA-B, BSA-C and BSA-D Switched Access services and Special Access. It is optional for FGA and BSA-A Switched Access Services.

Applies to All Exchanges Illinois

FACILITIES FOR INTRASTATE ACCESS

2. GENERAL REGULATIONS (Cont'd)

2.7 FIA Services Provided By More Than One Telephone Company (Cont'd)

2.7.3 Meet Point Billing: (Cont'd)

There are two Meet Point Billing Options - Single Bill and Multiple Bill. The Telephone Company must notify the customer of:

- the Meet Point Billing Option that will be used,
- the Telephone Company(s) that will render the bill(s),
- the Telephone Company(s) to whom payment(s) should be remitted, and
- the Telephone Company(s) that will provide the bill inquiry function.

The Telephone Company shall provide such notification at the time that an ASR is placed requesting access service. Additionally, the Telephone Company shall provide this notice in writing 30 days in advance of any change.

(A) Single Bill Option

The Single Bill Option allows the customer to receive one bill from one telephone company or its billing agent for access services.

The Telephone Company(s) that renders the bill to the customer may provide to the customer, cross references to the other Telephone Company(s) service and/or the common circuit identifiers based upon industry standards as contained in the MECAB document. Should a billing dispute arise, the terms and conditions of the Billing Company(s) will apply.

Applies to All Exchanges Illinois

FACILITIES FOR INTRASTATE ACCESS

2. GENERAL REGULATIONS (Cont'd)

2.7 FIA Services Provided By More Than One Telephone Company (Cont'd)

2.7.3 Meet Point Billing (Cont'd)

(A) Single Bill Option (Cont'd)

For usage rated access services the access minutes of use will be compiled by the Initial Billing Company and used by the Initial Billing Company and any subsequent Billing Company(s) for the development of access charges.

- The Initial Billing Company for FGB, FGC, FGD, BSA-B, BSA-C and BSA-D Switched Access services is normally the end user's serving office and for WATS usage the Initial Billing Company is normally the WATS serving office. When the Initial Billing Company is other than the normally designated Telephone Company, the Telephone Company will notify the customer.
- The Subsequent Billing Company(s) is any Telephone Company(s) in whose territory a segment of the Switched Transport Facility is provided and/or where the CDL is located.

The Single Bill option provides three billing alternatives, Single Bill/Single Tariff, Single Bill/Pass-Through Billing and Single Bill/Multiple Tariff which are described following:

(1) Single Bill/Single Tariff

Each Telephone Company will receive an ASR or a copy of the ASR from the customer as specified in 3.3(A)(2) and arrange to provide the service. The Initial Billing Company will:

- determine the applicable charges and bill in accordance with its tariff;
- include all recurring and nonrecurring rates and charges of its tariff;
- forward the bill to the customer.

The customer will remit the payment to the Initial Billing Company.

Applies to All Exchanges Illinois

FACILITIES FOR INTRASTATE ACCESS

2. GENERAL REGULATIONS (Cont'd)

2.7 FIA Services Provided By More Than One Telephone Company (Cont'd)

2.7.3 Meet Point Billing (Cont'd)

(A) Single Bill Option (Cont'd)

(2) Single Bill/Pass-Through Billing

Each Telephone Company will receive an ASR or a copy of the ASR from the customer as specified in 3.3(A)(2) and arrange to provide the service. Each Telephone Company will:

- determine its portion of Switched Transport and/or Special Transport;
- determine the applicable charges and bill in accordance with its tariff;
- include all recurring and nonrecurring rates and charges of its tariff; and
- forward the bill to the Initial Billing Company for meet point billed access services.

The Initial Billing Company will:

- apply usage data, when needed, to the bill and calculate the charges;
- identify each involved Telephone Company's charges separately on the bill;
- combine all the bills of the involved Telephone Companies of a meet point billed access service into one access bill;
- forward the bill to the customer; and
- advise the customer how to remit the payment, either directly to each Telephone Company involved in the provision of this meet point billed service; or, as a single payment made to the Initial Billing Company. If payments are to be sent directly to the Initial Billing Company, the Subsequent Billing Company(s) will provide the customer with written authorization for the payment arrangement.

Applies to All Exchanges Illinois

FACILITIES FOR INTRASTATE ACCESS

2. GENERAL REGULATIONS (Cont'd)

2.7 FIA Services Provided By More Than One Telephone Company (Cont'd)

2.7.3 Meet Point Billing (Cont'd)

(A) Single Bill Option (Cont'd)

(3) Single Bill/Multiple Tariff

Each Telephone Company will receive an ASR or a copy of the ASR from the customer as specified in 3.3(A)(2) and arrange to provide the service. The Initial Billing Company will:

- determine each Telephone Company's portion of switched transport and/or special transport as in 2.7
- determine the applicable charges and bill in accordance with each Telephone Company's tariff;
- include all recurring and nonrecurring charges for each involved Telephone Company;
- identify each involved Telephone Company's charges separately on the bill;
- forward the bill to the customer; and
- advise the customer how to remit the payment, either directly to each Telephone Company involved in the provision of this meet point billed service; or, as a single payment made to the Initial Billing Company. If payments are to be sent directly to the Initial Billing Company, the Subsequent Billing Company(s) will provide the customer with written authorization for the payment arrangement.

(B) Multiple Bill Option

The Multiple Bill option allows all Telephone Companies providing service to bill the customer for their portion of a jointly provided access service. Each Telephone Company will:

Applies to All Exchanges Illinois

FACILITIES FOR INTRASTATE ACCESS

2. GENERAL REGULATIONS (Cont'd)

2.7 FIA Services Provided By More Than One Telephone Company (Cont'd)

2.7.3 Meet Point Billing (Cont'd)

(B) Multiple Bill Option (Cont'd)

- determine its portion of the Switched Transport and/or Special Transport as set forth in 2.7;
- determine the applicable charges and bill in accordance with its tariff;
- include all recurring and nonrecurring rates and charges of its tariff; and
- forward the bill to the customer.

The customer will remit the payments directly to each Telephone Company.

(C) Meet Point Billing Mileage Calculation

Each Telephone Company's portion of the Switched Transport and/or Special Transport mileage will be determined as follows:

- (1) For Switched Access Tandem-Switched Transport Services, determine the appropriate Tandem-Switched Transport - Facility total miles by computing the number of miles from the access tandem to the serving wire center in the Access Area (i.e., end user serving wire center, or WATS Serving Office), using the V&H method as set forth in the NECA Tariff FCC No. 4. For Special Access Services, and Switched Access Direct-Trunked Transport determine the appropriate Special Transport or Direct-Trunked Transport total miles by computing the number of miles between the serving wire centers involved (i.e., CDL serving wire center, Hub Wire Center, WATS Serving Office, end office, or access tandem) using the V&H method as set forth in the NECA Tariff FCC No. 4. Where the calculated miles include a fraction, the value is rounded up to the next full mile.

Applies to All Exchanges Illinois

FACILITIES FOR INTRASTATE ACCESS

2. GENERAL REGULATIONS (Cont'd)

2.7 FIA Services Provided By More Than One Telephone Company (Cont'd)

2.7.3 Meet Point Billing (Cont'd)

(C) Meet Point Billing Mileage Calculation (Cont'd)

Each Telephone Company's portion of the Switched Transport and/or Special Transport mileage will be determined as follows:

- (2) Determine the billing percentage (BP), as set forth in the NECA Tariff FCC No. 4. This represents the portion of the Service provided by each telephone company.
- (3) When Tandem Switched Transport is provided to a terminating carrier (N) different from a Frontier Telephone ILEC Company, Terminating – Tandem 3rd party rates are applicable otherwise Terminating – Tandem Affiliate rates are applicable. When originating Tandem Switched Transport is provided, Originating rates are applicable. (N)

Applies to All Exchanges Illinois

FACILITIES FOR INTRASTATE ACCESS

2. GENERAL REGULATIONS (Cont'd)

2.7 FIA Services Provided By More Than One Telephone Company (Cont'd)

2.7.3 Meet Point Billing (Cont'd)

(C) Meet Point Billing Mileage Calculation (Cont'd)

(4) Examples

Example 1 – Originating Switched Access

- Feature Group D Switched access is ordered to End Office.
- Originating End Office and Access Tandem are in the operating territory of a Telephone Company (TC-A).
- Customer Designated Premises is in the operating territory of a Telephone Company (TC-B)
- Assumptions:
 - TC-A Direct Trunk Transport BP = 40%
 - TC-B Direct Trunk Transport BP = 60%
 - Direct Trunked Transport mileage = 26 mi.
 - Tandem Switched Transport mileage = 23 mi.
- Telephone Company A charges are:
 - End Office charges = 9,000 min. x EO rate
 - Tandem Switched Transport Facility charge = 9,000 min. x 23 mi. x TSF rate
 - Tandem Switched Transport Termination charge = 2 terminations x 9,000 min. x TST rate
 - Tandem Switching Rate = 9,000 min. x TS rate
 - Direct Trunked Facility charge = 26 mi. x DTF rate x 40%
 - Direct Trunked Termination charge = 1 termination x DTT rate
 - Shared Multiplexing charge = 9,000 min. x 23 mi. x SM rate

Applies to All Exchanges Illinois

FACILITIES FOR INTRASTATE ACCESS

2. GENERAL REGULATIONS (Cont'd)

2.7 FIA Services Provided By More Than One Telephone Company (Cont'd)

2.7.3 Meet Point Billing (Cont'd)

(C) Meet Point Billing Mileage Calculation (Cont'd)

(4) Examples (Cont'd)

Example 2 – Terminating Switched Access – Tandem 3rd Party

- Feature Group D Switched Access is ordered to End Office.
- Terminating Access Tandem is owned by Frontier Telephone ILEC Companies (TC-A) and end office is owned by a non-Frontier Telephone ILEC Company.
- Assumptions:
 - TC-A Direct Trunk Transport BP = 40%
 - TC-B Direct Trunk Transport BP = 60%
 - Direct Trunk Transport mileage = 26 mi.
 - TC-A Tandem Switched Transport BP = 20%
 - TC-B Tandem Switched Transport BP = 80%
 - Tandem Switched Transport mileage = 23 mi.
- Telephone Company A charges are:
 - Tandem Switched Transport Facility-3rd Party charge = 9,000 min. x 23 mi. x TSF-3rd Party rate x 20%
 - Tandem Switched Transport Termination-3rd Party charge = 1 termination x 9,000 min. x TST – 3rd Party rate
 - Tandem Switching-3rd Party Rate = 9,000 min. x TS-3rd Party rate
 - Direct Trunked Facility charge = 26 mi. x DTF rate x 40%
 - Direct Trunked Termination charge = 1 termination x DTT rate
 - Shared Multiplexing 3rd Party Charge = 9,000 min. x 23 mi. x SM-3rd Party rate

Applies to All Exchanges Illinois

FACILITIES FOR INTRASTATE ACCESS

2. GENERAL REGULATIONS (Cont'd)

2.7 FIA Services Provided By More Than One Telephone Company (Cont'd)

2.7.3 Meet Point Billing (Cont'd)

(C) Meet Point Billing Mileage Calculation (Cont'd)

(4) Examples (Cont'd)

Example 3 –Terminating Switched Access Tandem End Office

- Feature Group D Switched Access is ordered to End Office.
- Terminating End Office and Access Tandem are both owned by Frontier Telephone ILEC Companies (TC-A).
- Assumptions:
 - TC-A Direct Trunk Transport BP = 40%
 - TC-B Direct Trunk Transport BP = 60%
 - Direct Trunk Transport mileage = 26 mi.
 - Tandem Switched Transport mileage = 23 mi.
- Telephone Company A charges are:
 - End office Charges = 9,000 min. x EO rate
 - Tandem Switched Facility – End Office charge = 9,000 min. x 23 mi. x TSF-End Office rate.
 - Tandem Switched Transport Termination –End Office charge = 2 terminations x 9.000 min. x TST-End Office rate.
 - Tandem Switching – End Office charge = 9,000 min. x TS-End Office rate
 - Direct Trunked Facility Charge = 26 mi x DTF rate x 40%
 - Direct Trunked Termination charge – 1 termination x DTT rate
 - Shared Multiplexing charge = 9,000 min. x 23 mi. x SM rate

Applies to All Exchanges Illinois

FACILITIES FOR INTRASTATE ACCESS

2. GENERAL REGULATIONS (Cont'd)

2.7 FIA Services Provided By More Than One Telephone Company (Cont'd)

2.7.3 Meet Point Billing (Cont'd)

(C) Meet Point Billing Mileage Calculation (Cont'd)

(4) Examples (Cont'd)

Example 4 –Terminating Switched Access-Tandem 3rd Party

- Feature Group D Switched Access is ordered to End Office.
- Terminating Access Tandem is owned by Frontier Telephone ILEC Companies (TC-A). Terminating End Office is owned by a non-Frontier Telephone ILEC Company.
- Assumptions:
 - Direct Trunk Transport mileage = 26 mi.
 - TC-A Tandem Switched Transport BP = 20%
 - TC-B Tandem Switched Transport BP = 80%
 - Tandem Switched Transport mileage = 23 mi.
- Telephone Company A charges are:
 - Tandem Switched Transport Facility-3rd Party charge = 9,000 min. x 23 mi. x TSF-3rd Party rate x 20%
 - Tandem Switched Transport Termination-3rd Party charge = 1 termination x 9,000 min. x TST – 3rd Party rate
 - Tandem Switching-3rd Party Rate = 9,000 min. x TS-3rd Party rate
 - Direct Trunked Facility charge = 26 mi. x DTF rate
 - Direct Trunked Termination charge = 2 terminations x DTT rate
 - Shared Multiplexing-3rd Party Charge = 9,000 min. x 23 mi. x SM-3rd Party rate

Issued: May 16, 2017

Effective: July 1, 2017

By Kenneth Mason
Vice President
of Government and Regulatory Affairs

Applies to All Exchanges Illinois

FACILITIES FOR INTRASTATE ACCESS

2. GENERAL REGULATIONS (Cont'd)

2.7 FIA Services Provided By More Than One Telephone Company (Cont'd)

2.7.3 Meet Point Billing (Cont'd)

(C) Meet Point Billing Mileage Calculation (Cont'd)

(4) Examples (Cont'd)

Example 5 – Originating Switched Access Frontier Telephone ILEC Company owns only the End Office.

- Feature Group D Switched Access is ordered to End Office.
- End Office is owned by Frontier Telephone ILEC Companies (TC-A).
- Access Tandem is owned by a non-Frontier Telephone ILEC Company (TC-B)
- Assumptions:
 - Direct Trunk Transport mileage = 26 mi.
 - TC-A Tandem Switched Transport BP = 80%
 - TC-B Tandem Switched Transport BP = 20%
 - Tandem Switched Transport mileage = 23 mi.
- Telephone Company A charges are:
 - End Office Charges = 9,000 min. x EO rate
 - Tandem Switched Transport Facility charge = 9,000 min. x 23 mi. x TSF rate x 80%.
 - Tandem Switched Transport Termination charge = 1 termination x 9.000 min. x TST rate.

Applies to All Exchanges Illinois

FACILITIES FOR INTRASTATE ACCESS

2. GENERAL REGULATIONS (Cont'd)

2.7 FIA Services Provided By More Than One Telephone Company (Cont'd)

2.7.3 Meet Point Billing (Cont'd)

(C) Meet Point Billing Mileage Calculation (Cont'd)

(4) Examples (Cont'd)

Example 6 – Terminating Switched Access – Tandem 3rd Party

- Feature Group D Switched Access is ordered to End Office.
- End Office is owned by Frontier Telephone ILEC Companies (TC-A).
- Access Tandem is owned by a non-Frontier Telephone ILEC Company (TC-B)
- Telephone Company A charges are:
 - End Office Charges = 9,000 min. x EO rate
 - Tandem Switched Transport Facility-3rd Party charge = 9,000 min. x 23 mi. x TSF-3rd Party rate x 80%.
 - Tandem Switched Transport Termination-3rd Party charge = 1 termination x 9.000 min. x TST-3rd Party rate.

Issued: May 16, 2017

Effective: July 1, 2017

By Kenneth Mason
Vice President
of Government and Regulatory Affairs

Applies to All Exchanges Illinois

FACILITIES FOR INTRASTATE ACCESS

2. GENERAL REGULATIONS (Cont'd)

2.7 FIA Services Provided By More Than One Telephone Company (Cont'd)

2.7.3 Meet Point Billing: (Cont'd)

(C) Meet Point Billing Mileage Calculation (Cont'd)

(3) (Cont'd)

Example of Billing Percentage (BP) Method Using the Multiple Bill Option: (Cont'd)

Issued: May 10, 2011

Effective: July 1, 2011

By Kenneth Mason
Vice President
of Government and Regulatory Affairs

Applies to All Exchanges Illinois

FACILITIES FOR INTRASTATE ACCESS

2. GENERAL REGULATIONS (Cont'd)

2.7 FIA Services Provided By More Than One Telephone Company (Cont'd)

2.7.3 Meet Point Billing: (Cont'd)

(C) Meet Point Billing Mileage Calculation (Cont'd)

(3) (Cont'd)

(D) All other appropriate recurring and nonrecurring charges in each telephone company's Access tariff are applicable.

(E) Where the Tandem-Switched Transport - Facility is provided by more than one telephone company, the Tandem-Switched Transport - Termination rate applies for the termination at the Telephone Company end of the Tandem-Switched Transport (i.e., the first point of switching or the end office serving the end user). The Tandem-Switched Transport - Termination rate will not apply when the Telephone Company is the intermediate provider of the Switched Transport Facility.

(F) The Interconnection charge for Switched Transport shall be billed by the Telephone Company in whose territory the end office is located.

Issued: May 10, 2011

Effective: July 1, 2011

By Kenneth Mason
Vice President
of Government and Regulatory Affairs

Applies to All Exchanges Illinois

FACILITIES FOR INTRASTATE ACCESS

2. GENERAL REGULATIONS (Cont'd)

2.7 FIA Services Provided By More Than One Telephone Company (Cont'd)

2.7.3 Meet Point Billing: (Cont'd)

- (G) The Shared Trunk Port for Tandem-Switched Transport shall be billed by the Telephone Company in whose territory the end office is located.
- (H) For tandem routed trunks, the Dedicated Trunk Port shall be billed by the Telephone Company owning the tandem. For end office direct routed trunks, the Dedicated Trunk Port shall be billed by the Telephone Company owning the end office on a single bill, single tariff or multiple bill, multiple tariff meet point billing arrangement.
- (I) The Shared Multiplexing charge will be assessed to the interexchange carrier by the Telephone Company owning the access tandem under the multiple bill, multiple tariff meet point billing option, and to the initial billing company, by the Telephone Company owning the access tandem, under the single bill, single tariff meet point billing option.

Applies to All Exchanges Illinois

FACILITIES FOR INTRASTATE ACCESS

2. GENERAL REGULATIONS (Cont'd)

2.7 FIA Services Provided By More Than One Telephone Company (Cont'd)

2.7.4 Zone Density Meet Point Billing

When the Switched Transport facility (Direct-Trunked or Tandem-Switched Transport) and/or Special Transport is provided by more than one telephone company, the following regulations apply:

(A) Switched Access

(1) End Office or Access Tandem is in Frontier Territory:

- (a) Distance sensitive transport provided by the Telephone Company will be rated according to the zone of the Telephone Company's end office or Telephone Company's access tandem.
- (b) The transport termination provided by the Telephone Company will be rated according to the zone assigned to the Telephone Company's end office or Telephone Company's access tandem.
- (c) Tandem Switching will be rated according to the zone of the Telephone Company's access tandem.

(2) Frontier is intermediate provider of the transport:

- (a) Distance sensitive transport will be rated at Zone 1 rates.
- (b) The transport termination rate does not apply if the Telephone Company is the intermediate provider of the transport facility.

Applies to All Exchanges Illinois

FACILITIES FOR INTRASTATE ACCESS

2. GENERAL REGULATIONS (Cont'd)

2.7 FIA Services Provided By More Than One Telephone Company (Cont'd)

2.7.4 Zone Density Meet Point Billing (Cont'd)

(B) Special Access

- (1) End Office or Access Tandem is in Frontier Territory:
 - (a) Special transport provided by the Telephone Company will be rated according to the zone of the Telephone Company's end office or Telephone Company's access tandem.
 - (b) The transport termination provided by the Telephone Company will be rated according to the zone assigned to the Telephone Company's end office or Telephone Company's access tandem.
- (2) Frontier is intermediate provider of the transport:
 - (a) Distance sensitive transport will be rated at Zone 1/Band A rates.
 - (b) The transport termination rate does not apply if the Telephone Company is the intermediate provider of the transport facility.

Issued: May 10, 2011

Effective: July 1, 2011

By Kenneth Mason
Vice President
of Government and Regulatory Affairs

Applies to All Exchanges Illinois

FACILITIES FOR INTRASTATE ACCESS

SECTION 3 TABLE OF CONTENTS

3. <u>ORDERING OPTIONS FOR FIA</u>	<u>Page</u>
3.1 <u>General</u>	2
3.1.1 Ordering Conditions	2
3.1.2 Provision of Other Services.....	12
3.1.3 Special Construction.....	13
3.1.4 Expanded Interconnection Service (EIS).....	13
3.1.5 Tandem Switch Signaling	13
3.2 <u>Access Service Request</u>	13
3.2.1 Service Date Intervals.....	13
3.2.2 ASR Modifications	14
(A) Service Date Change Charge	15
(B) Partial Cancellation Charge	16
(C) Discontinuance of Service	17
(D) Design Change Charge	17
(E) Requests for Expedition.....	18
3.2.3 Selection of Facilities for Access Service.....	18
3.2.4 Minimum Period.....	18
3.2.5 Minimum Period Charges	20
3.2.6 Cancellation of an ASR.....	21
3.2.7 Discontinuance of Switched Access FGD or BSA-D	25
3.2.8 FGD or BSA-D Maximum Per Trunk Cancellation Charge.....	26
3.3 <u>Access Service Requests For Services Provided By More Than One Telephone Company</u>	26

Applies to All Exchanges Illinois

FACILITIES FOR INTRASTATE ACCESS

3. ORDERING OPTIONS FOR FIA (Cont'd)

3.1 General

This section sets forth the regulations and order related charges for FIA Orders to provide the customer with FIA. These charges are in addition to other applicable charges in other sections of this Tariff.

3.1.1 Ordering Conditions

(A) A customer may order any amount of FIA (Switched or Special) of the same interface type, same Feature Group, same BSA or same Special Access between the same locations for installation on the same date on a single FIA ASR. A customer may order the changed use of Switched Access and Special Access over the same high capacity facility, however, separate FIA ASRs are required.

- ASRs for FGA or BSA-A must specify the number of lines required.
- ASRs for FGB, FGC, FGD, BSA-B, BSA-C, BSA-D and SAC Access Service must specify the number of trunks required or Busy Hour Minutes of Capacity (BHMC). For Tandem-Switched Transport, the customer has the option of specifying the number of trunks or Busy Hour Minutes of Capacity (BHMC). In addition, the ASR must indicate whether the Switched Transport ordered is for Entrance Facilities, Direct-Trunked Transport and/or Tandem-Switched Transport. For Direct-Trunked Transport, and Entrance Facilities the ASR must specify channel type, channel interface, and any options desired. In addition, ASRs for Direct-Trunked Transport must specify Facility Hubs involved.

Additional ASR requirements for Switched Access Service are described in Section 4 following.

*Effective December 2, 2005, this service is no longer available to new customers and current customers may not make changes or additions to existing service.

Applies to All Exchanges Illinois

FACILITIES FOR INTRASTATE ACCESS

3. ORDERING OPTIONS FOR FIA (Cont'd)

3.1 General (Cont'd)

3.1.1 Ordering Conditions (Cont'd)

- (B) The customer shall supply all details necessary to complete an order. The details may include the following: requested service date, customer name, customer designated location, end office, Interface Arrangement, type of Switched Access or Special Access, Supplemental Features, End Office Services and Signaling Interface, and originating and terminating capacity required. The customer may also be required to provide end user name and location, end user contact person, and end user premises access information to complete an order for Special Access.

When a customer orders mixed interstate and intrastate Switched Access, the customer is required to provide an estimate of the percent of traffic, as described in 4.3.3, which will be interstate. If the customer fails to provide this estimate, the order will not be processed until such time as the customer provides this estimate.

When a customer orders mixed-use special access service, the customer must indicate the jurisdiction based on the criteria in Section 5.

For Packet Switching Network Service*, the packet carrier must provide a Percent of Interstate usage (PIU) in the Main Remarks section of the ASR when service is initially ordered. This PIU will be used as the basis for prorating the packet usage charges to the interstate and intrastate jurisdictions. The packet switching carrier may submit an updated PIU report in writing at any time following one full month's billing. The updated report will become effective on the first day of the next monthly billing period which begins at least 15 business days after the date the revised report is received by the Telephone Company.

* Effective December 2, 2005, this service is no longer available to new customers and current customers may not make changes or additions to existing service.

Applies to All Exchanges Illinois

FACILITIES FOR INTRASTATE ACCESS

3. ORDERING OPTIONS FOR FIA (Cont'd)

3.1 General (Cont'd)

3.1.1 Ordering Conditions (Cont'd)

- (C) When the Alternate Traffic Routing Optional Arrangement is ordered, more than one CDL will be supplied and the number of trunks or BHMC for FGB, FGC and FGD to each CDL shall be specified.

When the Alternate Traffic Routing Basic Serving Element (BSE) is ordered, more than one CDL will be supplied and the number of trunks or BHMC for BSA-B, BSA-C, and BSA-D to each CDL shall be specified.

- (D) The customer shall order SAC Access Service, as described in 4.2.1(E), in the same manner as ordering FGD or BSA-D with the following exceptions. For 500 SAC Access Service or 900 SAC Access Service, customers may request direct connections to only those offices designated by the Telephone Company as 500 SAC Access Service or 900 SAC Access Service screening offices. All 500 NXX or 900 NXX code assignments and administration shall be in accordance with the North American Numbering Plan (NANP). 800, 877, 888 SAC Access Service is offered only in conjunction with the 800/877/888 Customer Identification Function as described in 4.2.10 and in conjunction with 800/877/888 Data Base Query Service as described in 4.2.18. Customers may request 800/877/888 SAC access connections to suitably equipped end offices and access tandem offices. A list of those offices will be provided upon request. All 800, 877 or 888 number assignments shall be administered by the Number Administration Service Center (NASC) through the Service Management System (SMS).

500 NXX Codes or 900 NXX Codes to be activated and/or deactivated in conjunction with 500 SAC Access Service or 900 SAC Access Service, must be provided to the Telephone Company at least 30 business days prior to the effective date of the change.

Issued: May 10, 2011

Effective: July 1, 2011

By Kenneth Mason
Vice President
of Government and Regulatory Affairs

Applies to All Exchanges Illinois

FACILITIES FOR INTRASTATE ACCESS

3. ORDERING OPTIONS FOR FIA (Cont'd)

3.1 General (Cont'd)

3.1.1 Ordering Conditions (Cont'd)

(D) (Cont'd)

An ASR is required by the Telephone Company for 500 NXX codes or 900 NXX codes to be activated or deactivated on an access facility level basis. The Switched Access Ordering Charge as described in 4.5.2(F) will apply. In addition to the Switched Access Ordering Charge, the NXX Translation Charge, as described in Section 4.5.2(G), shall apply to each 500 NXX code activated or deactivated in a Telephone Company switch capable of performing the Customer Identification Function for 500 SAC Access Service. Customer assigned codes for which an ASR has not been received will be blocked.

When SAC Access Service is not terminated over a Special Access Line as in 5.1.1(B)(2), the customer must notify the Telephone Company of all local exchange telephone numbers to which SAC Access Service traffic is designated so that the Telephone Company can balance the end office in accordance with standard Telephone Company engineering practices for heavy volume lines.

- (E) To determine if adequate central office facilities (i.e., trunk circuits) for FGD or BSA-D will be available on the conversion date to equal access and to be eligible for the allocation in the following paragraph all customers (including those customers who convert existing FGA, FGB, FGC, BSA-A, BSA-B and BSA-C to FGD or to BSA-D) must order FGD or BSA-D 120 days prior to an end office conversion to equal access.

When trunk circuits are not available to meet the demand an allocation of available trunk circuits will be required. The allocation of available facilities is a three step process as described below:

Applies to All Exchanges Illinois

FACILITIES FOR INTRASTATE ACCESS

3. ORDERING OPTIONS FOR FIA (Cont'd)

3.1 General (Cont'd)

3.1.1 Ordering Conditions (Cont'd)

(E) (Cont'd)

In this example assume nine ICs have ordered BHMCs which necessitate 1,000 FGD trunks where only 800 FGD trunk circuits are available at the conversion date.

Step 1: Provide an initial flat 25% distribution of available trunk circuits to each requesting IC except for incremental requests over existing levels of FGC.

(See table in Step 3.)

- $25\% \times 800$ (available facilities) = 200
- $\frac{200}{(9-1)} = 25$

Step 2: Assign all remaining trunk circuits proportionately, working from bottom up until ICs, as a result of the proration, are assigned less facilities than desired. First determine facilities available for apportionment.

- $800 - 175 = 625$ (eligible ICs are A, B, C, D, E, F)
- $\left(\frac{\text{Desired Facilities}}{\text{Total Desired Facilities}} \right) \times \text{Remaining Facilities}$
(of Remaining Facilities)
- $F = \frac{70}{1000 - 50} \times 625 = 46$ (assign only 45)(**)
- $E = \frac{80}{1000 - 120} \times (625 - 45) = 53$

(E receives less facilities than originally ordered, i.e., $53 + 25 = 78$)

** Will not assign more than desired.

Applies to All Exchanges Illinois

FACILITIES FOR INTRASTATE ACCESS

3. ORDERING OPTIONS FOR FIA (Cont'd)

3.1 General (Cont'd)

3.1.1 Ordering Conditions (Cont'd)

(E) (Cont'd)

Step 3: .. When an IC receives less facilities than desired, the remainder of ICs are allocated according to the following allocation factor:

$$\underline{\text{Remaining Facilities}} = \underline{625 - 98} = \underline{527} = .659$$

Total Desired Facilities 1000 - 200 800
of Remaining Eligible ICs
of Access

- D = 100 x .659 = 66
- C = 200 x .659 = 132
- B = 200 x .659 = 132
- A = 300 x .659 = 197

Applies to All Exchanges Illinois

FACILITIES FOR INTRASTATE ACCESS

3. ORDERING OPTIONS FOR FIA (Cont'd)3.1 General (Cont'd)3.1.1 Ordering Conditions (Cont'd)

(E) (Cont'd)

<u>ICs</u>	<u>Demand</u>	<u>Resources</u>	<u>Step 1</u>		<u>Step 2</u>	<u>Total</u>	
	<u>Desired</u>		<u>Flat 25%</u>	<u>Assigned</u>		<u>Trunk Circuits</u>	
	<u>(In Trunks)</u>	<u>Available</u>	<u>Distribution</u>		<u>Step 3</u>		
A	300	-	25	-	197	222	
B	200	-	25	-	132	157	
C(*)	200	-	-0-	-	132	132	
D	100	-	25	-	66	91	
E	80	-	25	53	-	78	
F	70	-	25	45(**)	-	-	70
G	25	-	25	-	-	25	
H	15	-	15(**)	-	-	15	
I	<u>10</u>	<u>-</u>	<u>10(**)</u>	<u>-</u>	<u>-</u>	<u>10</u>	
Total	1,000	800	175	98	527	800	

(*) Request for additional trunk circuits by an IC with existing FGC or BSA-C

(**) Will not assign more than desired

(F) The provision of Special Access requires the selection of a Terminating Option as defined in 5.3. The provision of Switched Access requires an Entrance Facility as defined in 4.2.3(B). When a customer orders a DS3 SAL or DS3 Switched Entrance Facility, he may specify, on the ASR, if the interface is to be an electrical or optical. In the event the customer does not specify an interface preference for DS3, the Telephone Company will provide an electrical interface.

Issued: May 10, 2011

Effective: July 1, 2011

By Kenneth Mason
Vice President
of Government and Regulatory Affairs

Applies to All Exchanges Illinois

FACILITIES FOR INTRASTATE ACCESS

3. ORDERING OPTIONS FOR FIA (Cont'd)

3.1 General (Cont'd)

3.1.1 Ordering Conditions (Cont'd)

(F) (Cont'd)

When a customer orders a FiberConnect SAL he must specify, whether the interface is to be an electrical or optical termination and indicate the Network Channel Interface (NCI) code on the ASR. Each FiberConnect SAL accommodates four DS1 transports.

When a customer orders DS3C SAL, the Telephone Company will provide an optical interface unless service is provided via microwave, in which case an electro-magnetic interface is provided, or unless the customer specifies on the ASR a request for an electrical interface.

(G) An ASR is required from the customer to request the unblocking of 0+900 calls. For an initial customer order at the tandem or end office level, the Telephone Company must receive the request to unblock 0+900 dialing capability at least 60 business days prior to the requested effective date. To block or unblock 0+900 dialing capability for NXX codes assigned to a customer in an end office subtending a previously unblocked tandem, a request must be received at least 30 business days prior to the requested effective date of the change.

Applies to All Exchanges Illinois

FACILITIES FOR INTRASTATE ACCESS

3. ORDERING OPTIONS FOR FIA (Cont'd)

3.1 General (Cont'd)

3.1.1 Ordering Conditions (Cont'd)

- (H) An ASR is required from the customer to add 1+ coin traffic from an end office. At the customer's option, the ASR can be issued at a 1+ coin tandem or end office level. For an initial customer order at a 1+ coin tandem, the Telephone Company must receive the request at least 120 calendar days prior to the requested effective date. Standard provisioning intervals will apply to subsequent orders involving that 1+ coin tandem.

The customer must provide the Telephone Company with written notification stating that an order is being submitted pursuant to an agreement with a secondary service provider prior to the routing of 1+ interMSA coin traffic to a provider other than the customer.

- (I) When ordering Operator Services, an ASR is required to establish a new FGC, FGD, BSA-C or BSA-D trunk group(s) or to add Operator Services to an existing FGC, FGD, BSA-C or BSA-D trunk group between the Telephone Company's Operator Services Switching Location and one CDL in the same MSA.

When measurement capability does not exist for Operator Services per call charges, a forecast of the number of Operator Services calls anticipated is required from the customer as set forth in 8.3.3 when the initial order for Operator Services is placed.

- (J) When ordering Signaling System 7 (SS7) Out of Band Signaling as described in 4.2.5, the customer shall provide an ASR specifying a reference to existing CCS7 Access service facilities or reference to a related ASR for CCS7 Access service as such CCS7 Access Service facilities are described in the Company's Interstate Tariff FCC No. 4. The customer's ASR shall also include STP point codes, STP location identifier codes, FGD or BSA-D trunk or 800/887/888 Service Access trunk circuit identification codes, and switch type.

Applies to All Exchanges Illinois

FACILITIES FOR INTRASTATE ACCESS

3. ORDERING OPTIONS FOR FIA (Cont'd)

3.1 General (Cont'd)

3.1.1 Ordering Conditions (Cont'd)

(J) (Cont'd)

When ordering SS7 Out of Band Signaling for FGD or BSA-D, the customer shall specify that all traffic carried by that FGD or BSA-D will be equipped with out of band signaling. The customer shall work cooperatively with the Telephone Company to determine the number of CCS7 Access service connections required to handle the customer's SS7 Out of Band Signaling traffic.

(K) When ordering Expanded Interconnection Services (EIS) the customer shall place an ASR for the Cross Connect, as described in 5.1.1(C), to interconnect the facilities of the Telephone Company to the facilities of the customer. Each service application used in conjunction with EIS will require a separate ASR. When ordering additions or changes to the existing EIS facilities, the customer must refer to the specific EIS facilities affected by the addition or change.

(L) When a Customer orders Tandem Switch Signaling (TSS), as described in 4.2.5 and 4.2.20, to be established with the installation of a new FGD or BSA-D trunk group, 500 SAC Access Service or 900 SAC Access Service trunk group, the Switched Access Ordering charge, per ASR and the appropriate Service Installation charge will apply for the installation of the FGD, BSA-D or 500 SAC Access Service or 900 SAC Access Services. TSS can only be provided from equal access end offices.

When a Customer orders Tandem Switch Signaling to be added to an existing FGD, BSA-D trunk group, 500 SAC Access Service or 900 SAC Access Service trunk group or to a pending ASR, only the Switched Access Ordering charge and the Design Change charge will apply for the addition of the optional arrangement.

Applies to All Exchanges Illinois

FACILITIES FOR INTRASTATE ACCESS

3. ORDERING OPTIONS FOR FIA (Cont'd)

3.1 General (Cont'd)

3.1.1 Ordering Conditions (Cont'd)

- (M) When ordering FGD or BSA-D Switched Access with 950-XXXX Access as described in 4.2.5, the customer shall provide an ASR specifying which 950-XXXX access code(s) are to be routed and the FGD or BSA-D Switched Access Service over which resulting originating 950-XXXX access code calls are to be routed.
- (N) When ordering Carrier Identification Parameter (CIP) as described in 4.2.5, the Customer shall provide an ASR specifying a reference to existing FGD or BSA-D switched access services or reference to a related ASR for FGD or BSA-D switched access services. The Customer's ASR shall specify the information necessary to identify the trunk group to which the CIP is to be added.

3.1.2 Provision of Other Services

- (A) At the option of a customer, Directory Assistance, Additional Labor, Telecommunications Service Priority (TSP), Testing and Special Routing services may be ordered with an ASR at the same time the ASR is accepted by the Telephone Company. Such requests will be considered to be supplemental to the ASR. The rates and charges for these services as set forth in other sections of this tariff will apply in addition to the ordering charges set forth in this section and the rates and charges for the Switched Access or Special Access with which they are associated.
- (B) The items listed in (A) preceding may subsequently be added to the ASR at any time, up to and including the service date established by the ASR. When ordered subsequently, charges for ASR modifications as set forth in 3.2.2 following will apply.

Applies to All Exchanges Illinois

FACILITIES FOR INTRASTATE ACCESS

3. ORDERING OPTIONS FOR FIA (Cont'd)

3.1 General (Cont'd)

3.1.3 Special Construction

(A) The regulations, rates and charges for Special Construction in Section 10 are in addition to the regulations, rates and charges specified in this section.

(B) Special Construction is not applicable to EIS.

3.1.4 Expanded Interconnection Service (EIS)

The regulations, rates and charges for EIS are in addition to the regulations, rates and charges specified in this section.

3.1.5 Tandem Switch Signaling

The regulations, rates and charges for Tandem Switch Signaling in Sections 4 and 5 are in addition to the regulations, rates and charges specified in this section.

3.2 Access Service Request

An ASR is used by the Telephone Company to receive orders for the following types of FIA requested by the customer:

- Switched Access as in Section 4,
- Special Access as in Section 5,
- Expanded Interconnection Service
- Other Services as in other sections of the tariff.

3.2.1 Service Date Intervals

The time required to provision service is known as the service date interval. Such intervals will be established in accordance with published service date interval guidelines which are available to customers upon request. The service date interval guidelines will apply to ASRs and will specify the quantities of FIA that can be provided on the same service date. The customer may request a service date other than that established pursuant to the service date interval guidelines, and the Telephone Company, where possible, will establish the service date in accordance with such request, subject, however, to other applicable provisions of this tariff.

Applies to All Exchanges Illinois

FACILITIES FOR INTRASTATE ACCESS

3. ORDERING OPTIONS FOR FIA (Cont'd)

3.2 Access Service Request (Cont'd)

3.2.2 ASR Modifications

The customer may request a modification of his ASR prior to the service date. The Telephone Company will make every effort to accommodate a requested modification when it is able to do so with the normal work force assigned to complete such an ASR within normal business hours. If the modification cannot be made with the normal work force during normal business hours, the Telephone Company will notify the customer. If the customer still desires the ASR modification, the Telephone Company will schedule a new service date. All charges for ASR modifications will apply on a per occurrence basis. Where a new ASR may be required the appropriate charges in other sections of this tariff will be applicable.

Any increase in the number of Switched Access lines for FGA or BSA-A; trunks or BHMCs for FGB, FGC, FGD, BSA-B, BSA-C, BSA-D; SAC Access Service or Special Access circuits; and Advanced Communications Network services will require the issuance of a new ASR for the incremental capacity.

(A) Service Date Change Charge

ASR service dates may be changed, however, a Service Date Change Charge will apply for each service date change after the plant test date of the original ASR.

For Switched Access, the new service date may not exceed the original service date by more than 30 calendar days. If the requested service date is more than 30 calendar days after the original service date, the ASR will be cancelled by the Telephone Company and cancellation charges in 3.2.6 will apply. A new ASR will be reissued with the new service date.

Applies to All Exchanges Illinois

FACILITIES FOR INTRASTATE ACCESS

3. ORDERING OPTIONS FOR FIA (Cont'd)

3.2 Access Service Request (Cont'd)

3.2.2 ASR Modifications (Cont'd)

(A) Service Date Change Charge (Cont'd)

For Special Access, except as specified below, the new service date may not exceed the original service date by more than 30 calendar days. If the requested service date is more than 30 calendar days after the original service date, the ASR will be canceled by the Telephone Company. Cancellation charges in 3.2.6 will apply and the ASR will be reissued with the new service date unless the customer indicates that billing for the service is to commence as in 3.2.6.

With the agreement of the Telephone Company, a new service date may be established that is prior to the original service date and the provisions in will apply in addition to the Service Date Change Charge.

Service Date Change Charge \$66.47

(B) Partial Cancellation Charge

Any decrease in the number of Switched Access lines for FGA or BSA-A; trunks or BHMCs for FGB, FGC, FGD, BSA-B, BSA-C, BSA-D; SAC Access Service or Special Access circuits; or Advanced Communications Network services will be treated as a partial cancellation.

A customer may cancel any number of Special Access circuits or Advanced Communications Network services.

When a customer partially cancels the service ordered on an ASR, charges will apply as follows:

Applies to All Exchanges Illinois

FACILITIES FOR INTRASTATE ACCESS

3. ORDERING OPTIONS FOR FIA (Cont'd)

3.2 Access Service Request (Cont'd)

3.2.2 ASR Modifications (Cont'd)

(B) Partial Cancellation Charge (Cont'd)

- (1) Except as specified in 3.2.6, when an ASR for Switched Access Service is partially cancelled on or after the Scheduled Issue Date, the charge will be determined by multiplying the total Installation nonrecurring charges for the canceled portion of the order by the number of business days elapsed since the Scheduled Issue Date and dividing that figure by the number of days in the service interval and adding the Switched Access Ordering Charge.
- (2) When an ASR for Special Access Service or Advanced Communications Network service is partially cancelled on or after the Scheduled Issue Date, the charge will be determined by multiplying the total Special Access or Advanced Communications Network service nonrecurring charges for the canceled portion of the order by the number of business days elapsed since the Scheduled Issue Date and dividing that figure by the number of days in the service interval.
- (3) When a customer cancels part of an ASR for which billing has commenced as provided in 3.2.2 and 3.2.6, cancellation charges in 3.2.6 will apply to that part of the ASR being canceled.

Applies to All Exchanges Illinois

FACILITIES FOR INTRASTATE ACCESS

3. ORDERING OPTIONS FOR FIA (Cont'd)

3.2 Access Service Request (Cont'd)

3.2.2 ASR Modifications (Cont'd)

(C) Discontinuance of Service

A customer may discontinue FIA that is in service at any time. The request for discontinuance of service must be received by the Telephone Company at least two business days prior to the date on which service is to be disconnected and billing discontinued. The disconnect request may be submitted via the same method(s) used to place orders. The customer must notify the Telephone Company of a delay or cancellation in the discontinuance request prior to the disconnect date. The Telephone Company, where possible, will establish the disconnect date in accordance with such request. Billing and service will then continue until the new requested disconnect date. If a service is discontinued prior to the expiration of the Minimum Period in 3.2.4, the Minimum Period Charges in 3.2.5 may apply.

(D) Design Change Charge

The customer may request a design change to a pending ASR for both Switched and Special Access or request a change to an existing Switched Access Service. A design change is a change which requires engineering review. The regulations, rates and charges for a design change are in Section 4.5.2(A) for Switched Access Service, and Section 5.6.1(E)(1) for Special Access Service, and are in addition to the regulations, rates and charges specified in this section.

Applies to All Exchanges Illinois

FACILITIES FOR INTRASTATE ACCESS

3. ORDERING OPTIONS FOR FIA (Cont'd)3.2 Access Service Request (Cont'd)3.2.2 ASR Modifications (Cont'd)(E) Requests for Expedition

A customer may request an expedited service date. When this situation occurs, charges will be applicable as in 6.2. The Telephone Company will provide an estimate of the charges to the customer. The customer must accept the price estimate prior to the Telephone Company's performing the expedite. The actual charges billed to the customer will be no more than 10 percent over the estimate.

When placing an Access Service Request a customer may request a service date that is prior to the Telephone Company's published service date interval. If the Telephone Company determines that the service can be provided on the requested date, an Expedited Order Charge will apply.

A customer may also request an earlier service date on a pending Access Service Request. If the customer's request can be accommodated, a Service Date Change Charge as described in Section 3.2.2(A) will apply in addition to the Expedited Order Charge.

If the Telephone Company is subsequently unable to meet an agreed upon expedited service date, the Expedited Order Charge will not apply.

In the event that the Telephone Company provides service on an expedited basis by customer request and the customer then delays service, an additional Service Date Change Charge as described in Section 3.2.2(A) will apply.

The Expedited Order Charge applies per order, based on the requested service date. A request to expedite service to be available the next day is a one day expedite, a request for service in two days is a two day expedite, and so on to a request for service a week from the request date is a seven day expedite. A request for an expedite of more than seven days will be billed the seven day expedite rate.

(N)

(N)

Applies to All Exchanges Illinois

FACILITIES FOR INTRASTATE ACCESS

3. ORDERING OPTIONS FOR FIA (Cont'd)3.2 Access Service Request (Cont'd)3.2.2 ASR Modifications (Cont'd)(E) Requests for Expedition (Cont'd)

Expedited orders for same day service are not available. If the requested service date is at the published service date interval or later, no Expedited Order Charge will apply.

Frontier North Inc. OCN 1015

One Day Expedite	\$1,534.20
Two Day Expedite	1,251.20
Three Day Expedite	968.20
Four Day Expedite	685.20
Five Day Expedite	628.60
Six Day Expedite	572.00
Seven Day Expedite	515.40
Eight Day Expedite	515.40
Nine Day Expedite	515.40

Frontier North Inc. OCN 1036Frontier Communications of the Carolinas OCN 1000

One Day Expedite	\$1,500.00
Two Day Expedite	1,219.18
Three Day Expedite	938.65
Four Day Expedite	699.26
Five Day Expedite	699.26
Six Day Expedite	683.57
Seven Day Expedite	667.88
Eight Day Expedite	667.88
Nine Day Expedite	667.88

Issued: November 28, 2012

Effective: January 20, 2013

By Kenneth Mason
Vice President
of Government and Regulatory Affairs

Applies to All Exchanges Illinois

FACILITIES FOR INTRASTATE ACCESS

3. ORDERING OPTIONS FOR FIA (Cont'd)

3.2 Access Service Request (Cont'd)

3.2.3 Selection of Facilities for Access Service

(A) Requests for a specific circuit is not an option of the customer except as provided for under Special Facilities Routing of FIA in Section 9.

3.2.4 Minimum Period

(A) The Minimum Period for which Special Access, Frame Relay *, ¹, Packet Switching Network Service*, Basic Service Elements (BSEs) and Primary Interexchange Carrier Charge are provided and for which charges are applicable, is one month, except as in B through I. (C)

(B) The Minimum Period for Miscellaneous Services is in Section 6.

(C) The Minimum Period for Ancillary Services is as set forth in Section 8.

(D) The Minimum Period for temporary Videoband and program audio Special Access is the minimum period for which rates are established in Section 5.7.

* Grandfathered Offering.

¹ Effective May 31, 2022, Frontier will no longer support Moves, Adds or Changes nor new installations for [Frame Relay] Service. Upon service term expiration, this service will transition to a Month-to-Month service arrangement. (N)
|
(N)

Applies to All Exchanges Illinois

FACILITIES FOR INTRASTATE ACCESS

3. ORDERING OPTIONS FOR FIA (Cont'd)

3.2 Access Service Request (Cont'd)

3.2.4 Minimum Period (Cont'd)

- (E) The Minimum Period for FIA provided under Special Construction provisions and for which charges are applicable in Section 10.
- (F) The Minimum Period for FGA, FGB, FGC, BSA-A, BSA-B, BSA-C, SAC Access Service, and also for FGD or BSA-D ordered after the conversion of an end office to equal access, is one month. For the application of the minimum period charges for Switched Access Service FGB, FGC, BSA-B, BSA-C, SAC Access Service, and for FGD or BSA-D ordered after the conversion of an end office to Equal Access, it is assumed the last identical capacity placed in service is the first one discontinued.
- (G) For FGD or BSA-D ordered prior to the conversion of an end office to equal access and (1) cancelled prior to the conversion date, a Cancellation Charge in 3.2.6 applies or (2) cancelled on or after the equal access conversion date, a Discontinuance Charge in 3.2.7 applies.
- (H) The minimum periods for Special Access DS3 Service are in Section 5.6.11.
- (I) The minimum periods for Expanded Interconnection Services further outlined in this tariff.
- (J) The minimum periods for Advanced Communications Network services are set forth under Section 16.

Applies to All Exchanges Illinois

FACILITIES FOR INTRASTATE ACCESS

3. ORDERING OPTIONS FOR FIA (Cont'd)

3.2 Access Service Request (Cont'd)

3.2.5 Minimum Period Charges

When FIA are discontinued prior to the expiration of the Minimum Period, charges are applicable for the remaining month(s) and/or fraction thereof of the Minimum Period.

The Minimum Period Charge will be determined as follows:

- (A) For Switched Access usage sensitive rate elements, the charge for the minimum period, or fraction thereof, is equal to the applicable rates for the actual or assumed usage for the minimum period or such fraction thereof. For Switched Access flat-rated monthly elements (i.e., Entrance Facility, Direct-Trunked Transport and Multiplexing rates), the charge for the minimum period or fraction thereof is the applicable monthly rates for the service.
- (B) For Special Access, other than DS3 Service, the charge is the applicable monthly rate for the service(s) as in 5.7. For Special Access DS3 Service, the charges are in Section 5.
- (C) For FGD or BSA-D ordered prior to conversion of an end office to equal access, but canceled after the equal access conversion date, a Discontinuance Charge in 3.2.7 applies.
- (D) For part-time or occasional program audio Special Access services, the rates in 5.6.1, 5.7, and 5.8 will apply.
- (E) For FGA, FGB, BSA-A and BSA-B Type service where measurement equipment is not available and the Assumed Minutes of Use Monthly Surrogate is used, the charge will be the prorated amount on a daily basis, calculated at 1/30 of the applicable rate shown in Section 4.6.9, for each day of the minimum period the facility was in service.
- (F) For the Primary Interexchange Carrier Charge, the charge is the applicable monthly rate as in Section 12.

Applies to All Exchanges Illinois

FACILITIES FOR INTRASTATE ACCESS

3. ORDERING OPTIONS FOR FIA (Cont'd)

3.2 Access Service Request (Cont'd)

3.2.6 Cancellation of an ASR

- (A) A customer may cancel ordered FIA on any date prior to the service date. The cancellation date is the date the Telephone Company receives written or verbal notice from the customer that the ASR is to be cancelled. The verbal notice must be followed by written confirmation within 10 days.

For Switched Access Tandem-Switched Transport or ASRs requesting additional trunk activations on existing Direct-Trunked Transport facilities, if a customer is unable to accept service within 30 calendar days of the original service date, the ASR shall be considered canceled and charges in (C) and (D) will apply. In such instances, the cancellation date shall be the 31st calendar day beyond the original service date of the ASR.

For Special Access, and Switched Access Entrance Facilities and Direct-Trunked Transport, if a customer is unable to accept service within 30 calendar days of the original service date, the customer has the choice of the following options:

- The ASR shall be canceled and charges in (C) will apply, or
- Billing for the service will commence.

In either case, the cancellation date or the billing date shall commence on the 31st calendar day beyond the original service date of the ASR.

- (B) ASR costs are considered to have started when the Telephone Company incurs any cost in connection therewith or in preparation thereof which would not otherwise have been incurred. These costs include but are not limited to preliminary engineering, orders to suppliers, and other similar items of cost.

Applies to All Exchanges Illinois

FACILITIES FOR INTRASTATE ACCESS

3. ORDERING OPTIONS FOR FIA (Cont'd)

3.2 Access Service Request (Cont'd)

3.2.6 Cancellation of an ASR (Cont'd)

(C) When a customer cancels an ASR for the installation of new service, or an ASR to modify existing service, charges will apply as follows:

- (1) When an ASR for Switched Access Service is canceled on or after the Application Date, the Cancellation Charge is calculated, on a per order basis, by multiplying the total Installation nonrecurring charges for the quantity ordered by the number of business days elapsed since the Application Date, and dividing that figure by the number of days in the service interval (i.e., the number of business days between the Application Date and the last day of the service date interval) and adding the Switched Access Ordering Charge.
- (2) When an ASR for Special Access Service is canceled on or after the Application Date, the Cancellation Charge is calculated, on a per ASR basis, by multiplying the total nonrecurring charges for the quantity ordered by the number of business days elapsed since the Application Date, and dividing that figure by the number of days in the service interval (i.e., the number of business days between the order date and the last day of the service date interval).
- (3) When a customer chooses to commence billing rather than cancel an ASR for Special Access as in (A), the customer must submit an ASR prior to calendar day 31 from the original service date and request a service date change. The new service date may not exceed the original service date by more than 120 calendar days. Charges in 3.2.2(A) will only apply for each subsequent service date change request after calendar day 31, not to exceed 120 calendar days.

When a customer elects to commence billing, monthly recurring charges will begin accruing at calendar day 31 after the original service date. Upon completion of the ASR, the initial bill for Special Access Service will include these accrued charges and any additional nonrecurring charges in addition to billable charges specified in 2.4.1(C).

Applies to All Exchanges Illinois

FACILITIES FOR INTRASTATE ACCESS

3. ORDERING OPTIONS FOR FIA (Cont'd)

3.2 Access Service Request (Cont'd)

3.2.6 Cancellation of an ASR (Cont'd)

(C) (Cont'd)

(3) (Cont'd)

If the ASR is not completed within 121 calendar days of the original service date, the ASR will be canceled. Cancellation charges in (C)(2) will apply. In addition, the customer will be billed the accrued monthly recurring charges specified above plus any additional nonrecurring charges applicable for the service. These charges will be computed commencing at day 31 after the original service date up to and including the cancellation date, not to exceed 90 days of service (120 days from the original service date). The Telephone Company will not reissue an ASR with a new service date beyond 121 calendar days. It will be the customer's responsibility to submit a new ASR for Switched or Special Access Service.

Applies to All Exchanges Illinois

FACILITIES FOR INTRASTATE ACCESS

3. ORDERING OPTIONS FOR FIA (Cont'd)3.2 Access Service Request (Cont'd.)3.2.6 Cancellation of an ASR (Cont'd)

- (D) For cancellation of an ASR for Switched Access FGD or BSA-D before an end office converts to equal access, cancellation charges will apply if the Telephone Company is notified of the cancellation within a period of 12 months prior to the scheduled service date. Cancellation charges apply to each trunk cancelled.

When, due to a shortage of FGD or BSA-D facilities an allocation of FGD or BSA-D facilities is made, cancellation charges apply only to circuits allocated to the customer.

Cancellation charges will accrue to the maximum in equal monthly increments (i.e., maximum cancellation charge divided by 12) beginning twelve months before an end office converts to equal access. Maximum cancellation charges are listed in Section 3.2.8. The charge applied will be the accrued charge in the month during which notice of cancellation is received by the Telephone Company.

<u>Month During Which Notice Is Received Before Conversion</u>	<u>Date Charge (Per Trunk Cancelled)</u>
12	\$42.47
11	84.94
10	127.41
9	169.88
8	212.35
7	254.82
6	297.29
5	339.76
4	382.23
3	424.70
2	467.17
1	509.59

Applies to All Exchanges Illinois

FACILITIES FOR INTRASTATE ACCESS

3. ORDERING OPTIONS FOR FIA (Cont'd)3.2 Access Service Request (Cont'd.)3.2.7 Discontinuance of Switched Access FGD or BSA-D

A Discontinuance Charge applies if a customer discontinues FGD or BSA-D service provided at the conversion of an end office to equal access. The Discontinuance Charge applies to each FGD or BSA-D trunk discontinued with one exception. When the FGD or BSA-D service is a result of an upgrade from FGB, FGC, BSA-B, BSA-C or SAC Access Service trunks in service prior to conversion to equal access, the Discontinuance Charge will only apply to the number of FGD or BSA-D trunks being discontinued that are in excess of the number of FGB, FGC, BSA-B, BSA-C or SAC Access Service trunks in service prior to conversion to equal access. However, the customer may still be liable for any Minimum Period charges in 3.2.5 that may be applicable to the FGB, FGC, BSA-B, BSA-C or SAC Access Service trunks that were in service prior to conversion. For purposes of calculating the Discontinuance Charge the Maximum Discontinuance Charge will be amortized in equal monthly increments (i.e., Maximum Discontinuance Charge divided by 12) over a 12 month period beginning on the date the end office converts to equal access. The Maximum Discontinuance Charge is equal to the FGD or BSA-D Maximum Cancellation Charge in 3.2.8. The charge assessed will be the unamortized portion of the Maximum Discontinuance Charge.

Example:

<u>Month During Which Service is Discontinued After Conversion Date</u>	<u>Charge (Per Trunk Discontinued)</u>
1	\$509.59
2	467.17
3	424.70
4	382.23
5	339.76
6	297.29
7	254.82

Issued: May 10, 2011

Effective: July 1, 2011

By Kenneth Mason
Vice President
of Government and Regulatory Affairs

Applies to All Exchanges Illinois

 FACILITIES FOR INTRASTATE ACCESS
3. ORDERING OPTIONS FOR FIA (Cont'd)3.2 Access Service Request (Cont'd.)3.2.7 Discontinuance of Switched Access FGD or BSA-D (Cont'd)

Example:

Month During Which
Service is Discontinued
After Conversion Date

Charge (Per Trunk Discontinued)

8	212.35
9	169.88
10	127.41
11	84.94
12	42.47

3.2.8 FGD or BSA-D Maximum Per Trunk Cancellation Charge

\$509.59

3.3 Access Service Requests For Services Provided By More Than One Telephone Company

- (A) Switched or Special Access Services provided by more than one telephone company are services where one end of the Switched Transport or Special Transport facility is in the operating territory of one telephone company and the other end of the facility is in the operating territory of a different telephone company.

The ordering procedure for this service is in (1) and (2). The telephone company will notify the customer, identifying which ordering procedures will apply.

Applies to All Exchanges Illinois

FACILITIES FOR INTRASTATE ACCESS

3. ORDERING OPTIONS FOR FIA (Cont'd)

3.3 Access Service Requests For Services Provided By More Than One Telephone Company (Cont'd)

(A) (Cont'd)

(1) Single Company Billing

The telephone company receiving the ASR from the customer will arrange to provide the service and bill the customer as in 2.7.2. The customer will place the ASR with the telephone company as follows:

(a) For Switched Access Services the customer will place the ASR with the telephone company in whose territory the following is located:

- FGA or BSA-A - dial tone office

When the preceding is not in the same telephone company's territory as the customer designated location (CDL), the customer must supply a copy of the ASR to the telephone company in whose territory the CDL is located.

(2) Meet Point Billing

Each telephone company will provide its portion of the Switched Transport or Special Transport service within its operating territory to the meet point with the other telephone company(s). The BP will be determined by the telephone companies involved in providing the FIA service and listed in the NECA Tariff FCC No. 4.

For all Switched Access Services and all Special Access Services the order will be placed with the telephone company as specified in the Ordering and Billing Forum's Multiple Exchange Carrier Ordering and Design (MECOD) guidelines.

(B) When FGA or BSA-A is ordered in a Multicarrier Access Area, the customer must provide a copy of the order to the SEC. The SEC will bill as in 2.7.

Applies to All Exchanges Illinois

FACILITIES FOR INTRASTATE ACCESS

SECTION 4 TABLE OF CONTENTS

4. <u>SWITCHED ACCESS</u>	<u>Page</u>	
4.1 <u>General</u>	7	
4.2 <u>Rates and Charges – Frontier North Inc. (OCN 1015 Exchanges)</u>	8	
4.2.1 Nonrecurring Charges	8	
(A) Reserved	8	
(B) Switched Access Service Ordering Charges & Design Change Charge	8	
(C) 500 NXX Translation Charge	8	
(D) Applies to FGB, FGC, FGD, BSA-B, BSA-C & SAC Access Service	8	
(E) Per FGA or BSA-A Line Nonrecurring Charge	8	
(F) Per End Office – Nonrecurring Charge	8	
4.2.2 Switched Transport	9	
(A) Tandem-Switched Transport – Facility - Non Toll Free	9	(T)
(B) Tandem-Switched Transport - Termination - Non Toll Free	9	
(C) Tandem Switching Rate - Non Toll Free	10	
(D) Shared Multiplexing - Non Toll Free	10	
(E) Reserved for Future Use	10	
(F) Interconnection Rate - Non Toll Free and Toll Free	11	
(G) Direct-Trunked Transport-Voiceband	11	
(H) Direct-Trunked Transport – DS1	12	
(I) Direct-Trunked Transport – DS3	12	
(J) Dedicated Trunk Port	13	
(K) Entrance Facility – 2 Wire and 4-Wire Voiceband	13	
(L) Entrance Facility – DS1	14	
(M) Entrance Facility – DS3	14	
(N) Multiplexing	15	
(O) Entrance Facility – DS1 – Optional Payment Plan (Discount Rate)	15	(T)
4.2.3 End Office Services	16	
(A) Basic Toll Free Data Base	16	
(B) End Office Switching – Bundled (EOSB) - Non Toll Free	16	(T)
(C) End Office Switching – Unbundled (EOSU) Circuit Switched Line - Non Toll Free	17	
(D) End Office Switching – Unbundled (EOSU) Circuit Switched Trunk - Non Toll Free	17	
(E) Shared Trunk Port - Non Toll Free	17	(T)

Issued: May 11, 2021

Effective: July 1, 2021

By Kenneth Mason
 Vice President
 of Government and Regulatory Affairs

Applies to All Exchanges Illinois

FACILITIES FOR INTRASTATE ACCESS

SECTION 4 TABLE OF CONTENTS

4. <u>SWITCHED ACCESS</u> (Cont'd)	<u>Page</u>	
4.2 <u>Rates and Charges – Frontier North Inc. (OCN 1015 Exchanges)</u> (Cont'd)		
4.2.3 End Office Services (Cont'd)		
(F) End Office Switching – Bundled (EOSB) – Toll Free	17.1	(N)
(G) End Office Switching – Unbundled (EOSU) Circuit Switched Line – Toll Free	17.1	
(H) End Office Switching – Unbundled (EOSU) Circuit Switched Trunk – Toll Free	17.1	
(I) Shared Trunk Port – Toll Free	17.1	(N)
4.2.4 Information Surcharge – Non Toll Free and Toll Free	18	(T)
4.2.5 FGA or BSA-A Usage Sensitive Credit Allowance	18	
4.2.6 CCS7 Access Service – Dedicated Switched Access	19	
(A) 56 Kbps Digital Facilities	19	
(B) High Capacity Digital DS1 (1.544 Mbps) Facilities	19	
4.2.7 CCS7 Access Service – STP Port Termination	20	
4.2.8 Reserved	20	
4.2.9 Assumed Minutes of Use Monthly Surrogate	20	
4.2.10 Switched Access Cross Connect	21	
(A) Rates and Charges	21	
4.2.11 Basic Service Elements	21	
(A) Alternate Traffic Routing – BSE	21	
(B) Automatic Number Identification	21	
(C) User Transfer – BSE	22	
(D) Hunt Group Arrangement – BSE	22	
(E) Queuing – BSE	22	
(F) Uniform Call Distribution – BSE	23	
(G) Simplified Message Desk Interface (SMDI) – BSE	23	
(H) Premier Messaging Services Interface (PMSI) – BSE	23	
(I) Signaling System 7 Message Waiting Indicator (SS&MWI) Signaling Service – BSE	24	
(J) Remote Call Forwarding – BSE	24	
(K) Direct Inward Dialing (DID) – BSE	25	
(L) Billed Number Screening (BNS) – BSE	25	
4.2.12 Carrier Identification Parameter (CIP)	25	

Issued: May 11, 2021

Effective: July 1, 2021

By Kenneth Mason
 Vice President
 of Government and Regulatory Affairs

Applies to All Exchanges Illinois

FACILITIES FOR INTRASTATE ACCESS

SECTION 4 TABLE OF CONTENTS

4.	<u>SWITCHED ACCESS</u> (Cont'd)	<u>Page</u>	
4.3	<u>Rates and Charges – Frontier North Inc. (OCN 1036 Exchanges)</u>	26	
4.3.1	Local Switching – Bundled (EOSB) – Non Toll Free	26	(T)
4.3.2	Local Switching – Bundled (EOSB) – Toll Free	26	
4.3.3	Information Surcharge – Non Toll Free and Toll Free	26	
4.3.4	Entrance Facility 2-Wire and 4-Wire Voicegrade	26	
4.3.5	Entrance Facility – DS1	27	
4.3.6	Entrance Facility – DS3	27	
4.3.7	Direct-Trunked Transport-Voiceband	27	
4.3.8	Direct-Trunked Transport – DS1	27	
4.3.9	Direct-Trunked Transport – DS3	28	
4.3.10	End Office	28	
4.3.11	Shared Trunk Port – Non Toll Free	28	(T)
4.3.12	Shared Trunk Port – Toll Free	28	(N)
4.3.13	Shared Multiplexing – Non toll Free and Toll Free	29	(N)
4.3.14	Tandem-Switched Transport – Facility – Non Toll Free	29	(T)
4.3.15	Tandem-Switched Transport – Termination – Non Toll Free	29	
4.3.16	Tandem Switching Rate – Non Toll Free	30	(T)
4.3.17	Tandem Switching Rate – Toll Free	30	(N)
4.3.18	Interconnection Rate – Non Toll Free and Toll Free	30	(T)
4.3.19	Multiplexing	31	
4.3.20	Miscellaneous Switched Access Rates and Charges	31	(T)

Applies to All Exchanges Illinois

FACILITIES FOR INTRASTATE ACCESS

SECTION 4 TABLE OF CONTENTS

4. <u>SWITCHED ACCESS</u> (Cont'd)	<u>Page</u>	
4.3 <u>Rates and Charges – Frontier North Inc. (OCN 1036 Exchanges)</u> (Cont'd)		
4.3.21 Basic Service Elements (BSEs)	32	(T)
(A) Alternate Traffic Routing – BSE	32	
(B) Automatic Number Identification	32	
(C) User Transfer – BSE	33	
(D) Hunt Group Arrangement – BSE	33	
(E) Queuing – BSE	33	
(F) Uniform Call Distribution – BSE	33	
(G) Simplified Message Desk Interface (SMDI) – BSE	34	
(H) Premier Messaging Services Interface (PMSI) – BSE	34	
(I) Signaling System 7 Message Waiting Indicator (SS7MWI) Signaling Service	34	
(J) Remote Call Forwarding – BSE	34	
(K) Direct Inward Dialing (DID) – BSE	35	
(L) Billed Number Screening (BNS) – BSE	35	
(M) Answer Supervision – BSE	35	
(N) Switched Access Assumed Minutes of Use	35	
4.3.22 Switched Access Cross Connect	36	(T)
4.3.23 Carrier Identification Parameter (CIP)	36	
4.3.24 CCS7 Access Service – Dedicated Switched Access	36	(T)
(A) 56 Kbps Digital Facilities	36	
(B) High Capacity Digital DS1 (1.544 Mbps) Facilities	37	
4.3.25 CCS7 Access Service – RSTP or STP Port Termination	37	(T)

Applies to All Exchanges Illinois

FACILITIES FOR INTRASTATE ACCESS

SECTION 4 TABLE OF CONTENTS

4. <u>SWITCHED ACCESS</u> (Cont'd)	<u>Page</u>	
4.4 <u>Rates and Charges – Frontier Communications of the Carolinas (OCN 1000 Exchanges)</u>		
4.4.1 Nonrecurring Charges	44	
(A) Reserved	44	
(B) Switched Access Service Ordering Charges & Design Change Charge		
(C) 500 NXX Translation Charge	44	
(D) Applies to FGB, FGC, FGD, BSA-B, BSA-C & SAC Access Service		
(E) Per FGA or BSA-A Line Nonrecurring Charge	44	
(F) Per End Office – Nonrecurring Charge	44	
4.4.2 Switched Transport	45	
(A) Tandem-Switched Transport – Facility – Non Toll Free	45	(T)
(B) Tandem-Switched Transport - Termination – Non Toll Free	45	
(C) Tandem Switching Rate – Non Toll Free	46	
(D) Shared Multiplexing – Non Toll Free	46	(T)
(E) Joint Tandem Switched Transport Service – Toll Free	46	(N)
(F) Interconnection Rate – Non Toll Free and Toll Free	47	(T)
(G) Direct-Trunked Transport-Voiceband	48	
(H) Direct-Trunked Transport – DS1	48	
(I) Direct-Trunked Transport – DS3	49	
(J) Dedicated Trunk Port	49	
(K) Entrance Facility – 2 Wire and 4-Wire Voiceband	50	
(L) Entrance Facility – DS1	50	
(M) Entrance Facility – DS3	51	
(N) Multiplexing	51	
(O) Entrance Facility – DS1 – Optional Payment Plan (Discount Rate)	52	(T)

Items 4.4.3 through 4.4.5 relocated to Sheet No. 6.

(M)
 |
 (N)

Applies to All Exchanges Illinois

FACILITIES FOR INTRASTATE ACCESS

SECTION 4 TABLE OF CONTENTS

4. <u>SWITCHED ACCESS</u> (Cont'd)	<u>Page</u>	
4.4 <u>Rates and Charges – Frontier Communications of the Carolinas (OCN 1000 Exchanges)</u> (Cont'd)		
4.4.3 End Office Services	53	(M)
(A) Basic Toll Free Data Base	53	
(B) End Office Switching – Bundled (EOSB) – Non Toll Free	53	(T)
(C) End Office Switching – Unbundled (EOSU) Circuit Switched Line – Non Toll Free	54	
(D) End Office Switching – Unbundled (EOSU) Circuit Switched Trunk – Non Toll Free	54	
(E) Shared Trunk Port – Non Toll Free	55	(M)
(F) End Office Switching – Bundled (EOSB) – Toll Free	55	(N)
(G) End Office Switching – Unbundled (EOSU) Circuit Switched Line – Toll Free	55	
(H) End Office Switching – Unbundled (EOSU) Circuit Switched Trunk – Toll Free	55.1	
(I) Shared Trunk Port – Toll Free	55.1	(N)
4.4.4 Information Surcharge – Non Toll Free and Toll Free	55.1	(M)(T)
4.4.5 FGA or BSA-A Usage Sensitive Credit Allowance	56	(M)
4.4.6 CCS7 Access Service – Dedicated Switched Access	56	(N)
4.4.7 CCS7 Access Service - STP Port Termination	57	
4.4.8 Reserved	57	
4.4.9 Assumed Minutes of Use Monthly Surrogate	58	
4.4.10 Switched Access Cross Connect	58	
4.4.11 Basic Service Elements	59	
4.4.12 Carrier Identification Parameter (CIP)	63	(N)

Items 4.4.3 through 4.4.5 relocated from Sheet No. 5. (N)

Applies to All Exchanges Illinois

FACILITIES FOR INTRASTATE ACCESS

4. SWITCHED ACCESS (Cont'd)

4.1 General

Frontier North Inc. adopts, for intrastate services, Section 4 terms and conditions of Frontier Telephone Companies Tariff FCC No. 5 (the Telephone Company's interstate access tariff) for the exchanges with The Operating Company Number (OCN) of 1015 and Section 6 terms and conditions of Frontier Telephones Companies Tariff FCC No. 6 for those exchange with the OCN of 1036 effective as of July 1, 2012, and any successive issues thereto.

Frontier Communications of the Carolinas Inc. adopts, for intrastate services, Section 4 terms and conditions of Frontier Telephones Companies Tariff FCC No. 5 for those exchanges with the OCN of 1000 effective as of July 1, 2012, and any successive issues thereto.

(T)
(T)

These tariffs were filed with the FCC on behalf of the Telephone Company and affiliated companies. The tariffs include all the rules and regulations, under which interstate access services will be offered.

Specific exchanges by OCN can be found in Section 20 following.

Applies to All Exchanges Illinois

FACILITIES FOR INTRASTATE ACCESS

4. SWITCHED ACCESS (Cont'd)

4.2 Rates and Charges – Frontier North Inc. (OCN 1015 Exchanges)

4.2.1 Nonrecurring Charges

(A) Reserved

(B) Switched Access Service Ordering Charges and Design Change Charge

<u>Switched Access Ordering Charge</u>	<u>Design Change Charge</u>
<u>Per ASR</u>	<u>Per ASR</u>
100.00	52.81

(C) 500 NXX Translation Charge

<u>First NXX Per ASR/Per End Office</u>	<u>Each Additional NXX Per ASR/Per End Office</u>
20.00	10.00

(D) Applies to FGB, FGC, FGD, BSA-B, BSA-C, BSA-D and SAC Access Service

Per Call
.016

(E) Per FGA or BSA-A Line

Nonrecurring Charge
10.62

(F) Per End Office

Nonrecurring Charge
300.00

(C)

(C)

ued: June 29, 2012

Effective: July 1, 2012

By Kenneth Mason
 Vice President
 of Government and Regulatory Affairs

Applies to All Exchanges Illinois

FACILITIES FOR INTRASTATE ACCESS

4. SWITCHED ACCESS (Cont'd)

4.2 Rates and Charges – Frontier North Inc. (OCN 1015 Exchanges) (Cont'd)

4.2.2 Switched Transport

(A) Tandem-Switched Transport – Facility – Non Toll Free (C)

	<u>Tandem-Switched Transport - Facility</u>		
	Per Access		
	Minute Per		
	<u>Airline Mile</u>		
	<u>Originating</u>	<u>Terminating</u> <u>Affiliate</u>	<u>Terminating</u> <u>3rd Party</u>
Zone 1	0.0000020	0.00000	0.00000200
Zone 2	0.0000020	0.00000	0.00000200
Zone 3	0.0000020	0.00000	0.00000200

(B) Tandem-Switched Transport – Termination – Non Toll Free (C)

	<u>Tandem-Switched Transport - Termination</u>		
	Per Access		
	Minute, per		
	<u>Termination</u>		
	<u>Originating</u>	<u>Terminating</u> <u>Affiliate</u>	<u>Terminating</u> <u>3rd Party</u>
Zone 1	0.0000000	0.0000000	0.0000000
Zone 2	0.0000000	0.0000000	0.0000000
Zone 3	0.0000000	0.0000000	0.0000000

Applies to All Exchanges Illinois

FACILITIES FOR INTRASTATE ACCESS

4. SWITCHED ACCESS (Cont'd)

4.2 Rates and Charges – Frontier North Inc. (OCN 1015 Exchanges) (Cont'd)

4.2.2 Switched Transport (Cont'd)

(C) Tandem Switching Rate – Non Toll Free (C)

	<u>Tandem Switching Rate</u> <u>Per Access Minute</u>		
	<u>Originating</u>	<u>Terminating</u> <u>Affiliate</u>	<u>Terminating</u> <u>3rd party</u>
Zone 1	0.0018445	0.0000	0.0018445
Zone 2	0.0018445	0.0000	0.0018445
Zone 3	0.0018445	0.0000	0.0018445

(D) Shared Multiplexing – Non Toll Free (C)

	<u>Shared Multiplexing</u> <u>Per Access Minute</u>	
	<u>Originating</u>	<u>Terminating</u>
Zone 1	0.0000000	0.0000000
Zone 2	0.0000000	0.0000000
Zone 3	0.0000000	0.0000000

(E) Reserved for Future Use (T)

Applies to All Exchanges Illinois

FACILITIES FOR INTRASTATE ACCESS

4. SWITCHED ACCESS (Cont'd)

4.2 Rates and Charges – Frontier North Inc. (OCN 1015 Exchanges) (Cont'd)

4.2.2 Switched Transport (Cont'd)

(F) Interconnection Rate – Non Toll Free and Toll Free (T)(C)

<u>Nonpremium Rate</u>		<u>Premium Rate</u>	
Telephone Company Provided Transport		Telephone Company Provided Transport	
Per	Per	Per	Per
<u>Originating</u>	<u>Terminating</u>	<u>Originating</u>	<u>Terminating</u>
<u>Access Minute</u>	<u>Access Minute</u>	<u>Access Minute</u>	<u>Access Minute</u>
0.0000000	0.0000000	0.0000000	0.0000000

<u>Nonpremium Rate</u>		<u>Premium Rate</u>	
Per EIS	Per EIS	Per EIS	Per EIS
<u>Originating</u>	<u>Terminating</u>	<u>Originating</u>	<u>Terminating</u>
<u>Access Minute</u>	<u>Access Minute</u>	<u>Access Minute</u>	<u>Access Minute</u>
0.0	0.0000000	0.0000000	0.0000000

(G) Direct-Trunked Transport-Voiceband (T)

Direct-Trunked Transport Facility-Voiceband
Per Airline Mile, Per Month

\$2.90

Applies to All Exchanges Illinois

FACILITIES FOR INTRASTATE ACCESS

4. SWITCHED ACCESS (Cont'd)

4.2 Rates and Charges – Frontier North Inc. (OCN 1015 Exchanges) (Cont'd)

4.2.2 Switched Transport (Cont'd)

(H) Direct-Trunked Transport - DS1 (T)

	<u>Direct-Trunked</u> <u>Transport-Facility - DS1</u> <u>Per Airline Mile, Per Month</u>	<u>Direct-Trunked</u> <u>Transport-Termination - DS1</u> <u>Monthly Rate</u>
Zone 1	9.30	28.16
Zone 2	9.77	29.30
Zone 3	13.09	39.30

(I) Direct-Trunked Transport - DS3 (T)

	<u>Direct-Trunked</u> <u>Transport-Facility – DS3</u> <u>Per Airline Mile, Per Month</u>	<u>Direct-Trunked</u> <u>Transport-Termination – DS3</u> <u>Monthly Rate</u>
Zone 1	37.85	387.50
Zone 2	48.38	486.95
Zone 3	54.20	541.75

Applies to All Exchanges Illinois

FACILITIES FOR INTRASTATE ACCESS

4. SWITCHED ACCESS (Cont'd)

4.2 Rates and Charges – Frontier North Inc. (OCN 1015 Exchanges) (Cont'd)

4.2.2 Switched Transport (Cont'd)

(J) Dedicated Trunk Port

(T)

<u>End Office</u> <u>Dedicated Trunk Port</u> <u>Voiceband</u> <u>Monthly Rate, Per Channel</u>	<u>End Office</u> <u>Dedicated Trunk Port</u> <u>DS1</u> <u>Monthly Rate, Per Channel</u>
Originating 26.95 Terminating 0	Originating 4.23 Terminating 0

<u>Access Tandem</u> <u>Dedicated Trunk Port</u> <u>Voiceband</u> <u>Monthly Rate, Per Channel</u>	<u>Access Tandem</u> <u>Dedicated Trunk Port</u> <u>DS1</u> <u>Monthly Rate, Per Channel</u>
18.80	4.23

(K) Entrance Facility - 2-Wire and 4-Wire Voiceband

(T)

<u>Service</u> <u>Installation Charge</u> <u>Per Entrance Facility</u>	<u>Entrance Facility -</u> <u>2-Wire Voiceband</u> <u>Monthly Rate</u>	<u>Entrance Facility -</u> <u>4-Wire Voiceband</u> <u>Monthly Rate</u>
200.00	26.00	40.56

Applies to All Exchanges Illinois

FACILITIES FOR INTRASTATE ACCESS

4. SWITCHED ACCESS (Cont'd)

4.2 Rates and Charges – Frontier North Inc. (OCN 1015 Exchanges) (Cont'd)

4.2.2 Switched Transport (Cont'd)

(L) Entrance Facility - DS1

(T)

Entrance Facility - DS1
Each

	<u>Service Installation</u> <u>Charge</u>	<u>Monthly</u> <u>Rate</u>
Zone 1	450.00	185.00
Zone 2	450.00	235.00
Zone 3	450.00	240.00

(M) Entrance Facility, per DS3

(T)

	<u>Entrance Facility - DS3</u> <u>Electrical Interface</u>		<u>Entrance Facility - DS3</u> <u>Optical Interface</u>	
	<u>Installation</u> <u>Charge</u>	<u>Monthly</u> <u>Rate</u>	<u>Service</u> <u>Installation</u>	<u>Monthly</u> <u>Rate</u>
Zone 1	1,000.00	1,096.32	750.00	1,095.02
Zone 2	1,000.00	1,280.00	750.00	1,216.69
Zone 3	1,000.00	1,750.00	750.00	1,312.50

Applies to All Exchanges Illinois

FACILITIES FOR INTRASTATE ACCESS

4. SWITCHED ACCESS (Cont'd)

4.2 Rates and Charges – Frontier North Inc. (OCN 1015 Exchanges) (Cont'd)

4.2.2 Switched Transport (Cont'd)

(N) Multiplexing

(T)

	<u>DS1 To Voice</u>		<u>DS3 to DS1</u>	
	<u>Service Installation Charge</u>	<u>Monthly Rate</u>	<u>Service Installation Charge</u>	<u>Monthly Rate</u>
Zone 1	800.00	195.00	450.00	387.50
Zone 2	800.00	200.00	450.00	486.95
Zone 3	800.00	205.00	450.00	541.75

(O) Entrance Facility - DS1-Optional Payment Plan (Discounted Rate) *

(T)

	<u>Five Year Monthly Rate</u>
Zone 1	185.00
Zone 2	235.00
Zone 3	240.00

* Grandfathered to existing service effective December 31, 2003.

Applies to All Exchanges Illinois

FACILITIES FOR INTRASTATE ACCESS

4. SWITCHED ACCESS (Cont'd)

4.2 Rates and Charges – Frontier North Inc. (OCN 1015 Exchanges) (Cont'd)

4.2.3 End Office Services

(A) Basic Toll Free Data Base
Query Charge

Rate
Per Query

\$.0002

Premium Toll Free Data Base
Query Charge

Rate
Per Query

\$.0002

(R)

(B) End Office Switching - Bundled (EOSB) – Non Toll Free

The unbundled rates for End Office Switching are based on originating and terminating Access Minutes.

Nonpremium Rates
Per Access Minute

<u>Originating</u>	<u>Terminating</u>
.0008844	.00000000

Premium EOS1 and EOS2 Rates
Per Access Minute

<u>Originating</u>	<u>Terminating</u>
.0019653	.00000000

Applies to All Exchanges Illinois

FACILITIES FOR INTRASTATE ACCESS

4. SWITCHED ACCESS (Cont'd)

4.2 Rates and Charges – Frontier North Inc. (OCN 1015 Exchanges) (Cont'd)

4.2.3 End Office Services (Cont'd)

- (C) End Office Switching - Unbundled (EOSU) - Circuit Switched Line – Non Toll Free (C)
 (C)

The unbundled rates for End Office Switching are based on originating and terminating Access Minutes.

<u>Nonpremium Rates</u>		<u>Premium EOS1 and EOS2 Rates</u>	
<u>Per Access Minute</u>		<u>Per Access Minute</u>	
<u>Originating</u>	<u>Terminating</u>	<u>Originating</u>	<u>Terminating</u>
.0008844	.00000000	.0019653	.00000000

- (D) End Office Switching - Unbundled (EOSU) - Circuit Switched Trunk – Non Toll Free (C)
 (C)

The unbundled rates for End Office Switching are based on originating and terminating Access Minutes.

<u>Nonpremium Rates</u>		<u>Premium EOS1 and EOS2 Rates</u>	
		<u>Per Access Minute</u>	<u>Per Access Minute</u>
<u>Originating</u>	<u>Terminating</u>	<u>Originating</u>	<u>Terminating</u>
.0008844	.00000000	.0019653	.00000000

- (E) Shared Trunk Port – Non Toll Free (C)

<u>Per Access Minute</u>	
<u>Originating</u>	<u>Terminating</u>
.0006571	0

Applies to All Exchanges Illinois

FACILITIES FOR INTRASTATE ACCESS

4. SWITCHED ACCESS (Cont'd)

4.2 Rates and Charges – Frontier North Inc. (OCN 1015 Exchanges) (Cont'd)

4.2.3 End Office Services (Cont'd)

(F) End Office Switching - Bundled (EOSB) – Toll Free

(N)

The unbundled rates for End Office Switching are based on originating Access Minutes.

<u>Nonpremium Rates</u>	<u>Premium EOS1 and EOS2 Rates</u>
<u>Per Access</u>	<u>Per Access Minute</u>
<u>Originating</u>	<u>Originating</u>
*	*

(G) End Office Switching - Unbundled (EOSU) - Circuit Switched Line – Toll Free

The unbundled rates for End Office Switching are based on originating Access Minutes.

<u>Nonpremium Rates</u>	<u>Premium EOS1 and EOS2 Rates</u>
<u>Per Access Minute</u>	<u>Per Access Minute</u>
<u>Originating</u>	<u>Originating</u>
*	*

(H) End Office Switching - Unbundled (EOSU) - Circuit Switched Trunk – Toll Free

The unbundled rates for End Office Switching are based on originating Access Minutes.

<u>Nonpremium Rates</u>	<u>Premium EOS1 and EOS2 Rates</u>
<u>Originating</u>	<u>Per Access Minute</u>
	<u>Originating</u>
	*

(I) Shared Trunk Port – Toll Free

<u>Per Access Minute</u>
<u>Originating</u>
*

* See Frontier Telephone Companies Tariff FCC No. 5 for Toll Free rates.

(N)

Applies to All Exchanges Illinois

FACILITIES FOR INTRASTATE ACCESS

4. SWITCHED ACCESS (Cont'd)

4.2 Rates and Charges – Frontier North Inc. (OCN 1015 Exchanges) (Cont'd)

4.2.4 Information Surcharge - Non Toll Free and Toll Free

(C)

The rates for Information Surcharge are based on originating and terminating Access Minutes.

<u>Nonpremium Rates</u>	<u>Premium Rates</u>
<u>Information Surcharge</u>	<u>Information Surcharge</u>
<u>Per Access Minute</u>	<u>Per Access Minute</u>
.0000000	.0000000

4.2.5 FGA or BSA-A Usage Sensitive Credit Allowance

Usage Sensitive Service
Credit Allowance

Credit Per Originating FGA or BSA-A Access Minute #

.00403460

The credit is applied to the End Office Switching rate element.

Applies to All Exchanges Illinois

FACILITIES FOR INTRASTATE ACCESS

4. SWITCHED ACCESS (Cont'd)

4.2 Rates and Charges – Frontier North Inc. (OCN 1015 Exchanges) (Cont'd)

4.2.6 CCS7 Access Service - Dedicated Switched Access

(A) 56 Kbps Digital Facilities

<u>Dedicated Switched Access Transport (Per Airline Mile) Monthly Rate</u>	<u>Dedicated Switched Access Line Nonrecurring Charge Monthly Rate</u>	
2.50	100.00	66.44

(B) High Capacity Digital DS1 (1.544 Mbps) Facilities

<u>Dedicated Switched Access Transport (Per Airline Mile) Monthly Rate</u>	<u>Dedicated Switched Access Line Nonrecurring Charge Monthly Rate</u>	
40.06	1,500.00	264.94

(C)

(C)

Applies to All Exchanges Illinois

FACILITIES FOR INTRASTATE ACCESS

4. SWITCHED ACCESS (Cont'd)

4.2 Rates and Charges – Frontier North Inc. (OCN 1015 Exchanges) (Cont'd)

4.2.7 CCS7 Access Service - STP Port Termination

<u>Nonrecurring Charge</u>	<u>Monthly Rate</u>
43.00	429.97

4.2.8 Reserved

4.2.9 Assumed Minutes of Use Monthly Surrogate

<u>Per Two Way Line/Trunk</u>		<u>Per One Way Line/Trunk Originating Only</u>		<u>Terminating Only</u>	
<u>FGA or BSA-A</u>	<u>FGB or BSA-B</u>	<u>FGA or BSA-A</u>	<u>FGB or BSA-B</u>	<u>FGA or BSA-A</u>	<u>FGB or BSA-B</u>
2,451	(1)	(1)	(1)	13,026	(1)

(1) These s either have all existing services measured or have no customers at this time. In the event an ASR is received for a new customer and there is no measurement capability for the office requested, a traffic study will be made to establish a surrogate and such surrogate will be tariffed.

(C)

Applies to All Exchanges Illinois

FACILITIES FOR INTRASTATE ACCESS

4. SWITCHED ACCESS (Cont'd)

4.2 Rates and Charges – Frontier North Inc. (OCN 1015 Exchanges) (Cont'd)

(C)

4.2.10 Switched Access Cross Connect

(A) Rates and Charges

<u>DS0</u> Monthly <u>Rate</u>	<u>DS1</u> Monthly <u>Rate</u>	<u>DS3</u> Monthly <u>Rate</u>
1.77	4.53	36.64

4.2.11 Basic Service Elements

(A) Alternate Traffic Routing - BSE

<u>Nonpremium Nonrecurring</u> <u>Charge Per Trunk</u> <u>Group Equipped</u>	<u>Premium Nonrecurring</u> <u>Charge Per Trunk</u> <u>Group Equipped</u>
27.28	60.62

(B) Automatic Number Identification (ANI) - BSE

<u>Rate</u> <u>Per ANI Attempt</u>
0.00013

(C)

Applies to All Exchanges Illinois

FACILITIES FOR INTRASTATE ACCESS

4. SWITCHED ACCESS (Cont'd)

4.2 Rates and Charges – Frontier North Inc. (OCN 1015 Exchanges) (Cont'd)

4.2.11 Basic Service Elements (Cont'd)

(C) User Transfer - BSE

Monthly Rates
Per Line Arranged

1.50

(D) Hunt Group Arrangement - BSE

<u>Nonpremium Monthly Rates</u>	<u>Premium Monthly Rates</u>
<u>Per Line Equipped</u>	<u>Per Line Equipped</u>

1.35

3.00

(E) Queuing - BSE

<u>Nonpremium Monthly Rates</u>	<u>Premium Monthly Rates</u>
<u>Per Group Equipped</u>	<u>Per Group Equipped</u>

6.75

15.00

(C)

(C)

Applies to All Exchanges Illinois

FACILITIES FOR INTRASTATE ACCESS

4. SWITCHED ACCESS (Cont'd)

4.2 Rates and Charges – Frontier North Inc. (OCN 1015 Exchanges) (Cont'd)

4.2.11 Basic Service Elements (Cont'd)

(F) Uniform Call Distribution - BSE

<u>Nonpremium Monthly Rates</u>	<u>Premium Monthly Rates</u>
<u>Per Line Equipped</u>	<u>Per Line Equipped</u>

2.03

4.51

(G) Simplified Message Desk Interface (SMDI) - BSE

<u>Nonpremium</u>	<u>Premium</u>
<u>Monthly Recurring Rate</u>	<u>Monthly Recurring Rate</u>
<u>Per DNAL</u>	<u>Per DNAL</u>

88.31

196.25

(H) Premier Messaging Services Interface (PMSI) – BSE

	<u>Monthly</u>
	<u>Rate</u>
Premier Messaging Services Interface BSE - Per Arrangement, Per Month	\$500.00

(C)

(C)

Applies to All Exchanges Illinois

FACILITIES FOR INTRASTATE ACCESS

4. SWITCHED ACCESS (Cont'd)

4.2 Rates and Charges – Frontier North Inc. (OCN 1015 Exchanges) (Cont'd)

4.2.11 Basic Service Elements (Cont'd)

(I) Signaling System 7 Message Waiting Indicator (SS7MWI) Signaling Service – BSE

A) Signaling System 7 Message Waiting Indicator (SS7MWI) Signaling Service

Monthly
 Rate

SS7MWI Signaling Service

\$500.00 per Messaging
 Arrangement

(J) Remote Call Forwarding - BSE

<u>Nonpremium</u> <u>Monthly Recurring Rate</u> <u>Per Line</u> (FOMNX)	<u>Premium</u> <u>Monthly Recurring Rate</u> <u>Per Line</u> (FOMPX)
7.20	16.00

(C)

(C)

Applies to All Exchanges Illinois

FACILITIES FOR INTRASTATE ACCESS

4. SWITCHED ACCESS (Cont'd)

4.2 Rates and Charges – Frontier North Inc. (OCN 1015 Exchanges) (Cont'd)

4.2.11 Basic Service Elements (Cont'd)

(K) Direct Inward Dialing (DID) – BSE`

<u>Monthly Recurring Rate</u> <u>Per DID Term</u> (NDT)	<u>Monthly Recurring Rate</u> <u>Per Block of 20 Numbers</u> (ND4)
25.00	10.00

(L) Billed Number Screening (BNS) - BSE

<u>Monthly Recurring Rate</u> <u>Per Line Screened</u> (RTVXQ)
1.00

4.2.12 Carrier Identification Parameter (CIP)

<u>Non-Recurring</u> <u>Charge-Per CIC,</u> <u>Per End Office</u> <u>Direct Trunk</u> <u>Group</u>	<u>Non-Recurring</u> <u>Charge Per CIC,</u> <u>Per Access Tandem</u> <u>Direct Trunk</u> <u>Group</u>	<u>Monthly Recurring</u> <u>Charges</u> <u>Per Trunk</u>
80.00	1,120.00	.46

(C)

(C)

Applies to All Exchanges Illinois

FACILITIES FOR INTRASTATE ACCESS

4. SWITCHED ACCESS (Cont'd)

4.3 Rates and Charges – Frontier North Inc. (OCN 1036 Exchanges)

4.3.1 Local Switching - Bundled (EOSB) – Non Toll Free

(C)

<u>Premium Rate</u>		<u>Nonpremium Rate</u>	
<u>Local Switching</u>		<u>Local Switching</u>	
<u>Per Access Minute</u>		<u>Per Access Minute</u>	
<u>Originating</u>	<u>Terminating</u>	<u>Originating</u>	<u>Terminating</u>
\$.00196530	\$.00070000	\$.0008844	\$.00000000

Local Switching – Unbundled (EOSU) - Circuit Switched Line

<u>Premium Rate</u>		<u>Nonpremium Rate</u>	
<u>Local Switching</u>		<u>Local Switching</u>	
<u>Per Access Minute</u>		<u>Per Access Minute</u>	
<u>Originating</u>	<u>Terminating</u>	<u>Originating</u>	<u>Terminating</u>
\$.0019653	\$.00070000	\$.0008844	\$.00000000

Local Switching - Unbundled (EOSU) - Circuit Switched Trunk

<u>Premium Rate</u>		<u>Nonpremium Rate</u>	
<u>Local Switching</u>		<u>Local Switching</u>	
<u>Per Access Minute</u>		<u>Per Access Minute</u>	
<u>Originating</u>	<u>Terminating</u>	<u>Originating</u>	<u>Terminating</u>
\$.00196530	\$.00070000	\$.0008844	\$.00000000

4.3.2 Local Switching - Bundled (EOSB) – Toll Free

(N)

<u>Premium Rate</u>		<u>Nonpremium Rate</u>	
<u>Local Switching</u>		<u>Local Switching</u>	
<u>Per Access Minute</u>		<u>Per Access Minute</u>	
<u>Originating</u>		<u>Originating</u>	
*		*	

(N)

4.3.3 Information Surcharge – Non Toll Free and Toll Free

(C)

<u>Premium Rate</u>	<u>Nonpremium Rate</u>
<u>Information Surcharge</u>	<u>Information Surcharge</u>
<u>Per Access Minute</u>	<u>Per Access Minute</u>
\$.0000000	\$.0000000

Item 4.3.4 Relocated to Sheet No. 27.

(N)

* See Frontier Telephone Companies Tariff FCC No. 6 for Toll Free rates.

(N)

Applies to All Exchanges Illinois

FACILITIES FOR INTRASTATE ACCESS

4. SWITCHED ACCESS (Cont'd)

4.3 Rates and Charges – Frontier North Inc. (OCN 1036 Exchanges) (Cont'd)

4.3.4 Entrance Facility - 2-Wire and 4-Wire Voicegrade

<u>Service</u> <u>Installation Charge</u> <u>Per Entrance Facility</u> \$200.00	<u>Entrance Facility -</u> <u>2-Wire Voicegrade</u> <u>Monthly Rate</u> \$16.70	<u>Entrance Facility -</u> <u>4-Wire Voicegrade</u> <u>Monthly Rate</u> \$24.08
--	--	--

(T)(M)
 |
 (M)

4.3.5 Entrance Facility - DS1

<u>Service</u> <u>Installation Charge</u> <u>Per Entrance Facility</u> \$450.00	<u>Entrance Facility - DS1</u> <u>Monthly Rate</u> \$254.50
--	---

(T)

4.3.6 Entrance Facility - DS3

<u>Service</u> <u>Installation Charge</u> <u>Per Entrance Facility</u> \$1,000.00	<u>Entrance Facility - DS3</u> <u>Monthly Rate</u> \$1,300.00
--	---

(T)

4.3.7 Direct-Trunked Transport - Voicegrade

<u>Direct-Trunked Transport - Mileage</u> <u>Voicegrade Per Mile, Per Month</u> \$1.14	<u>Direct-Trunked Transport - Fixed</u> <u>Voicegrade Per Facility</u> \$15.30
--	--

(T)

4.3.8 Direct-Trunked Transport - DS1

<u>Direct-Trunked Transport - Mileage</u> <u>DS1 Per Mile, Per Month</u> \$8.03	<u>Direct-Trunked Transport - Fixed</u> <u>DS1 Per Facility</u> \$22.20
---	---

(T)

Item 4.3.4 Relocated from Sheet No. 26.

(N)

Issued: May 11, 2021

Effective: July 1, 2021

By Kenneth Mason
 Vice President
 of Government and Regulatory Affairs

Applies to All Exchanges Illinois

FACILITIES FOR INTRASTATE ACCESS

4. SWITCHED ACCESS (Cont'd)

4.3 Rates and Charges – Frontier North Inc. (OCN 1036 Exchanges) (Cont'd)

4.3.9 Direct-Trunked Transport - DS3 (T)

<u>Direct-Trunked Transport - Mileage</u>	<u>Direct-Trunked Transport - Fixed</u>
<u>DS3 Per Mile, Per Month</u>	<u>DS3 Per Facility</u>
\$21.00	\$200.00

4.3.10 End Office (T)

<u>Dedicated Trunk Port-Voicegrade</u>	<u>Dedicated Trunk Port - DS1</u>
<u>Monthly Rate, Per Channel</u>	<u>Monthly Rate, Per Channel</u>
Originating \$23.00	\$5.05
Terminating \$0.00	\$0.00

<u>Access Tandem</u>	<u>Access Tandem</u>
<u>Dedicated Trunk Port-Voicegrade</u>	<u>Dedicated Trunk Port - DS1</u>
<u>Monthly Rate, Per Channel</u>	<u>Monthly Rate, Per Channel</u>
\$16.36	\$5.05

4.3.11 Shared Trunk Port - Non Toll Free (T)(C)

<u>Shared Trunk Port</u>	
<u>Per Access Minute</u>	
<u>Originating</u>	<u>Terminating</u>
\$.0011316	\$ 0.00

4.3.12 Shared Trunk Port - Toll Free (N)

<u>Shared Trunk Port</u>
<u>Per Access Minute</u>
<u>Originating</u>
*

* See Frontier Telephone Companies Tariff FCC No. 6 for Toll Free rates.

Applies to All Exchanges Illinois

FACILITIES FOR INTRASTATE ACCESS

4. SWITCHED ACCESS (Cont'd)

4.3 Rates and Charges – Frontier North Inc. (OCN 1036 Exchanges) (Cont'd)

4.3.13 Shared Multiplexing – Non Toll Free (T)(C)

Shared Multiplexing
Per Access Minute

<u>Originating</u>	<u>Terminating</u>
\$.0000000	\$.0000000

4.3.14 Tandem-Switched Transport – Facility – Non Toll Free (T)(C)

Tandem-Switched Transport-Facility
Per Access Minute,
Per Airline Mile

<u>Originating</u>	<u>Terminating – Affiliate</u>	<u>Terminating - 3rd party</u>
\$.00000200	\$.0000000	\$.00000200

4.4.15 Tandem-Switched Transport – Termination – Non Toll Free (T)(C)

Tandem-Switched Transport-Termination
Per Access Minute,
Per Termination

<u>Originating</u>	<u>Terminating – Affiliate</u>	<u>Terminating – 3rd Party</u>
\$.0000000	\$.0000000	\$.0000000

Applies to All Exchanges Illinois

FACILITIES FOR INTRASTATE ACCESS

4. SWITCHED ACCESS (Cont'd)

4.3 Rates and Charges – Frontier North Inc. (OCN 1036 Exchanges) (Cont'd)

4.3.16 Tandem Switching Rate – Non Toll Free (T)(C)

Tandem-Switching Rate
Per Access Minute

<u>Originating</u>	<u>Terminating - Affiliate</u>	<u>Terminating - 3rd party</u>
\$.0018445	\$.000000	\$.00184450

4.3.17 Tandem Switching Rate – Toll Free (N)

Tandem-Switching Rate
Per Access Minute

Originating
 *

(N)
 |
 (N)

4.3.18 Interconnection Rate – Non Toll Free and Toll Free (T)(C)

Premium Rate

<u>Telephone Company Provided</u>	<u>Telephone Company Provided</u>
<u>Transport Per Originating</u>	<u>Transport Per Terminating</u>
<u>Access Minute</u>	<u>Access Minute</u>
\$.0000000	\$.0000000

Nonpremium Rate

<u>Telephone Company Provided</u>	<u>Telephone Company Provided</u>
<u>Transport Per Originating</u>	<u>Transport Per Terminating</u>
<u>Access Minute</u>	<u>Access Minute</u>
\$.0000000	\$.0000000

Premium Rate

<u>Per EIS Originating</u>	<u>Per EIS Terminating</u>
<u>Access Minute</u>	<u>Access Minute</u>
\$.0000000	\$.0000000

* See Frontier Telephone Companies Tariff FCC No. 6 for Toll Free rates.

(N)

Applies to All Exchanges Illinois

FACILITIES FOR INTRASTATE ACCESS

4. SWITCHED ACCESS (Cont'd)

4.3 Rates and Charges – Frontier North Inc. (OCN 1036 Exchanges) (Cont'd)

4.3.18 Interconnection Rate – Non Toll Free and Toll Free (Cont'd)

Nonpremium Rate

<u>Per EIS Originating Access Minute</u>	<u>Per EIS Terminating Access Minute</u>
\$.0000000	\$.0000000

4.3.19 Multiplexing

<u>DS1 to Voice</u>		<u>DS3 to DS1</u>	
<u>Service Installation Monthly Charge</u>	<u>Rate</u>	<u>Service Installation Monthly Charge</u>	<u>Rate</u>
\$800.00	\$184.60	\$450.00	\$130.00

4.3.20 Miscellaneous Switched Access Rates and Charges

Toll Free Data Base Query Service - Per Query	<u>Premium</u> \$.0002	<u>Basic</u> \$.0002	(R)
ASR Ordering Charge	<u>Per ASR</u> \$28.99		
FGD and BSA-D Blocking Charge	<u>Per Call</u> \$.01		

Applies to All Exchanges Illinois

FACILITIES FOR INTRASTATE ACCESS

4. SWITCHED ACCESS (Cont'd)

4.3 Rates and Charges – Frontier North Inc. (OCN 1036 Exchanges) (Cont'd)

4.3.20 Miscellaneous Switched Access Rates and Charges (Cont'd) (T)

	<u>1st NXX</u>	<u>Each Add'l NXX</u>
900 NXX Translation Nonrecurring Charge Per ASR/Per End Office	\$41.95	\$6.60
500 NXX Translation Nonrecurring Charge Per ASR/Per End Office	\$20.00	\$10.00

4.3.21 Basic Service Elements (BSEs) (T)

(A) Alternate Traffic Routing - BSE

<u>Premium Nonrecurring Rate</u> <u>Per Trunk Group</u> <u>Equipped</u>	<u>Nonpremium Nonrecurring Rate</u> <u>Per Trunk Group</u> <u>Equipped</u>
\$60.62	\$27.28

(B) Automatic Number Identification - (ANI) - BSE

Rate
Per ANI Attempt

\$.0001300

Applies to All Exchanges Illinois

FACILITIES FOR INTRASTATE ACCESS

4. SWITCHED ACCESS (Cont'd)

4.3 Rates and Charges – Frontier North Inc. (OCN 1036 Exchanges) (Cont'd)

4.3.21 Basic Service Elements (BSEs) (Cont'd)

(T)

(C) User Transfer - BSE

Monthly Rate
Per Line Arranged

\$1.02

(D) Hunt Group Arrangement - BSE

<u>Premium Monthly Rate</u>	<u>Nonpremium Monthly Rate</u>
<u>Per Line Equipped</u>	<u>Per Line Equipped</u>

\$0.06

\$0.03

(E) Queuing - BSE

<u>Premium Monthly Rate</u>	<u>Nonpremium Monthly Rate</u>
<u>Per Group Equipped</u>	<u>Per Group Equipped</u>

\$4.20

\$1.89

(F) Uniform Call Distribution - BSE

<u>Premium Monthly Rate</u>	<u>Nonpremium Monthly Rate</u>
<u>Per Line Equipped</u>	<u>Per Line Equipped</u>

\$4.51

\$2.03

Applies to All Exchanges Illinois

FACILITIES FOR INTRASTATE ACCESS

4. SWITCHED ACCESS (Cont'd)

4.3 Rates and Charges – Frontier North Inc. (OCN 1036 Exchanges) (Cont'd)

4.3.21 Basic Service Elements (BSEs) (Cont'd)

(T)

(G) Simplified Message Desk Interface (SMDI) - BSE

<u>Premium Monthly Rate</u>	<u>Nonpremium Monthly Rate</u>
<u>Per DNAL</u>	<u>Per DNAL</u>
\$196.25	\$88.31

(H) Premier Messaging Services Interface (PMSI)

Monthly Rate
Per Arrangement

\$500.00

(I) Signaling System 7 Message Waiting Indicator (SS7MWI) Signaling Service

Monthly Rate
Per Messaging Arrangement

\$500.00

(J) Remote Call Forwarding - BSE

<u>Premium Monthly Rate</u>	<u>Nonpremium Monthly Rate</u>
<u>Per Line</u>	<u>Per Line</u>
\$1.47	\$0.66

Applies to All Exchanges Illinois

FACILITIES FOR INTRASTATE ACCESS

4. SWITCHED ACCESS (Cont'd)

4.3 Rates and Charges – Frontier North Inc. (OCN 1036 Exchanges) (Cont'd)

4.3.21 Basic Service Elements (BSEs) (Cont'd)

(T)

(K) Direct Inward Dialing (DID) – BSE

<u>Monthly Rate</u> <u>Per DID Term</u>	<u>Monthly Rate</u> <u>Per Block of 20 Numbers</u>
\$10.82	\$2.74

(L) Billed Number Screening (BNS) - BSE

<u>Monthly Rate</u> <u>Per Line</u>
\$0.30

(M) Answer Supervision - BSE

<u>Monthly Rate</u> <u>Per Line</u>
\$6.35

(N) Switched Access Assumed Minutes of Use

	<u>Originating Only</u>	<u>Terminating Only</u>	<u>2-Way</u>
FGA and BSA-A	3231	2866	6097
FGB and BSA-B	5042	5042	5042

Applies to All Exchanges Illinois

FACILITIES FOR INTRASTATE ACCESS

4. SWITCHED ACCESS (Cont'd)

4.3 Rates and Charges – Frontier North Inc. (OCN 1036 Exchanges) (Cont'd)

4.3.22 Switched Access Cross Connect (T)

DS0 Monthly <u>Rate</u>	DS1 Monthly <u>Rate</u>	DS3 Monthly <u>Rate</u>
1.77	4.53	36.64

4.3.23 Carrier Identification Parameter (CIP) (T)

Non-Recurring Charge-Per CIC, Per End Office Direct Trunk <u>Group</u>	Non-Recurring Charge-Per CIC, Per Access Tandem Direct Trunk <u>Group</u>	Monthly Recurring Charge <u>Per Trunk</u>
80.00	1,120.00	.46

4.3.24 CCS7 Access Service - Dedicated Switched Access (T)

(A) 56 Kbps Digital Facilities

Dedicated Switched <u>Access Transport</u> (Per Airline Mile) <u>Monthly Rate</u>	<u>Dedicated Switched Access Line</u> Nonrecurring <u>Charge</u>	<u>Monthly Rate</u>
3.87	100.00	66.44

Applies to All Exchanges Illinois

FACILITIES FOR INTRASTATE ACCESS

4. SWITCHED ACCESS (Cont'd)

4.3 Rates and Charges – Frontier North Inc. (OCN 1036 Exchanges) (Cont'd)

4.3.24 CCS7 Access Service - Dedicated Switched Access (Cont'd) (T)

(B) High Capacity Digital DS1 (1.544 Mbps) Facilities

Dedicated Switched Access Transport (Per Airline Mile)	<u>Dedicated Switched Access Line</u> Nonrecurring	
<u>Monthly Rate</u>	<u>Charge</u>	<u>Monthly Rate</u>
40.06	1,500.00	264.94

4.3.25 CCS7 Access Service - RSTP or STP Port Termination (T)

Nonrecurring	Monthly
<u>Charge</u>	<u>Rate</u>
43.00	546.00

Applies to All Exchanges Illinois

FACILITIES FOR INTRASTATE ACCESS

4. RESERVED FOR FUTURE USE (Cont'd)

(D)

(D)

Applies to All Exchanges Illinois

FACILITIES FOR INTRASTATE ACCESS

4. RESERVED FOR FUTURE USE (Cont'd)

(D)

(D)

Applies to All Exchanges Illinois

FACILITIES FOR INTRASTATE ACCESS

4. RESERVED FOR FUTURE USE (Cont'd)

(D)

(D)

Applies to All Exchanges Illinois

FACILITIES FOR INTRASTATE ACCESS

4. RESERVED FOR FUTURE USE (Cont'd)

(D)

(D)

Applies to All Exchanges Illinois

FACILITIES FOR INTRASTATE ACCESS

4. RESERVED FOR FUTURE USE (Cont'd)

(D)

(D)

Applies to All Exchanges Illinois

FACILITIES FOR INTRASTATE ACCESS

4. RESERVED FOR FUTURE USE (Cont'd)

(D)

(D)

Applies to All Exchanges Illinois

FACILITIES FOR INTRASTATE ACCESS

4. SWITCHED ACCESS (Cont'd)

4.4 Rates and Charges – Frontier Communications of the Carolinas (OCN 1000 Exchanges)

(C)

4.4.1 Nonrecurring Charges

(A) Reserved

(B) Switched Access Service Ordering Charges & Design Change Charge

<u>Switched Access Ordering Charge</u>	<u>Design Change Charge</u>
<u>Per ASR</u>	<u>Per ASR</u>
100.00	52.81

(C) 500 NXX Translation Charge

<u>First NXX Per ASR/Per End Office</u>	<u>Each Additional NXX Per ASR/Per End Office</u>
20.00	10.00

(D) Applies to FGB, FGC, FGD, BSA-B, BSA-C, BSA-D & SAC Access Service

Per Call
.016

(E) Per FGA or BSA-A Line
Nonrecurring Charge
10.62

(F) Per End Office
Nonrecurring Charge

(C)

300.00

Applies to All Exchanges Illinois

FACILITIES FOR INTRASTATE ACCESS

4. SWITCHED ACCESS (Cont'd)4.4 Rates and Charges – Frontier Communications of the Carolinas (OCN 1000 Exchanges)
(Cont'd)4.4.2 Switched Transport(A) Tandem-Switched Transport – Facility – Non Toll Free

(C)

	<u>Tandem-Switched Transport - Facility</u>		
	Per Access		
	Minute Per		
	<u>Airline Mile</u>		
	<u>Originating</u>	Terminating <u>Affiliate</u>	Terminating <u>3rd Party</u>
Zone 1	0.0000020	0.00000	0.00000200
Zone 2	0.0000020	0.00000	0.00000200
Zone 3	0.0000020	0.00000	0.00000200

(B) Tandem-Switched Transport – Termination – Non Toll Free

(C)

	<u>Tandem-Switched Transport - Termination</u>		
	Per Access		
	Minute, per		
	<u>Termination</u>		
	<u>Originating</u>	Terminating <u>Affiliate</u>	Terminating <u>3rd Party</u>
Zone 1	0.0000000	0.0000000	0.0000000
Zone 2	0.0000000	0.0000000	0.0000000
Zone 3	0.0000000	0.0000000	0.0000000

Issued: May 11, 2021

Effective: July 1, 2021

By Kenneth Mason
Vice President
of Government and Regulatory Affairs

Applies to All Exchanges Illinois

FACILITIES FOR INTRASTATE ACCESS

4. SWITCHED ACCESS (Cont'd)

4.4 Rates and Charges – Frontier Communications of the Carolinas (OCN 1000 Exchanges)
 (Cont'd)

4.4.2 Switched Transport (Cont'd)

(C) Tandem Switching Rate – Non Toll Free (C)

	<u>Tandem Switching Rate</u>		
	<u>Per Access Minute</u>		
	<u>Originating</u>	<u>Terminating</u> <u>Affiliate</u>	<u>Terminating</u> <u>3rd Party</u>
Zone 1	0.0018445	0.0000	0.00184450
Zone 2	0.0018445	0.0000	0.00184450
Zone 3	0.0018445	0.0000	0.00184450

(D) Shared Multiplexing – Non Toll Free (C)

	<u>Shared Multiplexing</u>	
	<u>Per Access</u>	
	<u>Minute</u>	
	<u>Originating</u>	<u>Terminating</u>
Zone 1	0.0000000	0.0000000
Zone 2	0.0000000	0.0000000
Zone 3	0.0000000	0.0000000

(E) Joint Tandem Switched Transport Service – Toll Free (N)

	<u>Per Originating</u> <u>Access Minute</u>	(N)
Jurisdiction		
All Jurisdictions	\$0.0010000	(N)

Applies to All Exchanges Illinois

FACILITIES FOR INTRASTATE ACCESS

4. SWITCHED ACCESS (Cont'd)

4.4 Rates and Charges – Frontier Communications of the Carolinas (OCN 1000 Exchanges)
 (Cont'd)

4.4.2 Switched Transport (Cont'd)

(F) Interconnection Rate – Non Toll Free and Toll Free (T)(C)

<u>Nonpremium Rate</u>		<u>Premium Rate</u>	
Telephone Company Provided Transport		Telephone Company Provided Transport	
Per Originating <u>Access Minute</u>	Per Terminating <u>Access Minute</u>	Per Originating <u>Access Minute</u>	Per Terminating <u>Access Minute</u>
0.0000000	0.0000000	0.0000000	0.0000000
<u>Nonpremium Rate</u>		<u>Premium Rate</u>	
Per EIS Originating <u>Access Minute</u>	Per EIS Terminating <u>Access Minute</u>	Per EIS Originating <u>Access Minute</u>	Per EIS Terminating <u>Access Minute</u>
0.0000000	0.0000000	0.0000000	0.0000000

Applies to All Exchanges Illinois

FACILITIES FOR INTRASTATE ACCESS

4. SWITCHED ACCESS (Cont'd)

4.4 Rates and Charges – Frontier Communications of the Carolinas (OCN 1000 Exchanges)
 (Cont'd)

4.4.2 Switched Transport (Cont'd)

(G) Direct-Trunked Transport-Voiceband (T)

Direct-Trunked Transport Facility-Voiceband
Per Airline Mile, Per Month
 \$2.90

(H) Direct-Trunked Transport - DS1 (T)

	<u>Direct-Trunked</u> <u>Transport-Facility - DS1</u> <u>Per Airline Mile, Per Month</u>	<u>Direct-Trunked</u> <u>Transport-Termination - DS1</u> <u>Monthly Rate</u>
Zone 1	9.30	28.16
Zone 2	9.77	29.30
Zone 3	13.09	39.30

Applies to All Exchanges Illinois

FACILITIES FOR INTRASTATE ACCESS

4. SWITCHED ACCESS (Cont'd)

4.4 Rates and Charges – Frontier Communications of the Carolinas (OCN 1000 Exchanges)
 (Cont'd)

4.4.2 Switched Transport (Cont'd)

(I) Direct-Trunked Transport - DS3

(T)

	<u>Direct-Trunked</u> <u>Transport-Facility – DS3</u> <u>Per Airline Mile, Per Month</u>	<u>Direct-Trunked</u> <u>Transport-Termination – DS3</u> <u>Monthly Rate</u>
Zone 1	37.85	387.50
Zone 2	48.38	486.95
Zone 3	54.20	541.75

(J) Dedicated Trunk Port

(T)

	<u>End Office</u> <u>Dedicated Trunk Port</u> <u>Voiceband</u> <u>Monthly Rate, Per Channel</u>	<u>End Office</u> <u>Dedicated Trunk Port</u> <u>DS1</u> <u>Monthly Rate, Per Channel</u>
Originating	26.95	6.45
Terminating	0	0

	<u>Access Tandem</u> <u>Dedicated Trunk Port</u> <u>Voiceband</u> <u>Monthly Rate, Per Channel</u>	<u>Access Tandem</u> <u>Dedicated Trunk Port</u> <u>DS1</u> <u>Monthly Rate, Per Channel</u>
	28.91	18.80

Applies to All Exchanges Illinois

FACILITIES FOR INTRASTATE ACCESS

4. SWITCHED ACCESS (Cont'd)

4.4 Rates and Charges – Frontier Communications of the Carolinas (OCN 1000 Exchanges)
 (Cont'd)

4.4.2 Switched Transport (Cont'd)

(K) Entrance Facility - 2-Wire and 4-Wire Voiceband (T)

<u>Service Installation Charge Per Entrance Facility</u>	<u>Entrance Facility - 2-Wire Voiceband Monthly Rate</u>	<u>Entrance Facility - 4-Wire Voiceband Monthly Rate</u>
200.00	26.00	40.56

(L) Entrance Facility - DS1 (T)

	<u>Entrance Facility - DS1 Each</u>	
	<u>Service Installation Charge</u>	<u>Monthly Rate</u>
Zone 1	450.00	185.00
Zone 2	450.00	235.00
Zone 3	450.00	240.00

Applies to All Exchanges Illinois

FACILITIES FOR INTRASTATE ACCESS

4. SWITCHED ACCESS (Cont'd)

4.4 Rates and Charges – Frontier Communications of the Carolinas (OCN 1000 Exchanges)
 (Cont'd)

4.4.2 Switched Transport (Cont'd)

(M) Entrance Facility, per DS3 (T)

	<u>Entrance Facility - DS3</u> <u>Electrical Interface</u>		<u>Entrance Facility - DS3</u> <u>Optical Interface</u>	
	<u>Installation</u> <u>Charge</u>	<u>Monthly</u> <u>Rate</u>	<u>Service</u> <u>Installation</u>	<u>Monthly</u> <u>Rate</u>
Zone 1	1,000.00	1,096.32	750.00	1,095.02
Zone 2	1,000.00	1,280.00	750.00	1,216.69
Zone 3	1,000.00	1,750.00	750.00	1,312.50

(N) Multiplexing (T)

	<u>DS1 To Voice</u>		<u>DS3 to DS1</u>	
	<u>Service Installation</u> <u>Charge</u>	<u>Monthly</u> <u>Rate</u>	<u>Service Installation</u> <u>Charge</u>	<u>Monthly</u> <u>Rate</u>
Zone 1	800.00	195.00	450.00	387.50
Zone 2	800.00	200.00	450.00	486.95
Zone 3	800.00	205.00	450.00	541.75

Applies to All Exchanges Illinois

FACILITIES FOR INTRASTATE ACCESS

4. SWITCHED ACCESS (Cont'd)

4.4 Rates and Charges – Frontier Communications of the Carolinas
(OCN 1000 Exchanges) (Cont'd)

4.4.2 Switched Transport (Cont'd)

(O) Entrance Facility - DS1-Optional Payment Plan (Discounted Rate) *

(T)

	Five Year Monthly <u>Rate</u>
Zone 1	185.00
Zone 2	235.00
Zone 3	240.00

* Grandfathered to existing service effective December 31, 2003.

Applies to All Exchanges Illinois

FACILITIES FOR INTRASTATE ACCESS

4. SWITCHED ACCESS (Cont'd)

4.4 Rates and Charges – Frontier Communications of the Carolinas (OCN 1000 Exchanges) (Cont'd)

4.4.3 End Office Services

(A)	<u>Basic Toll Free Data Base Query Charge</u>	<u>Premium Toll Free Data Base Query Charge</u>	
	<u>Rate Per Query</u>	<u>Rate Per Query</u>	
	\$.0002	\$.0002	(R)

(B) End Office Switching - Bundled (EOSB) – Non Toll Free

The unbundled rates for End Office Switching are based on originating and terminating Access Minutes.

<u>Nonpremium Rates Per Access Minute</u>		<u>Premium EOS1 and EOS2 Rates Per Access Minute</u>	
<u>Originating</u>	<u>Terminating</u>	<u>Originating</u>	<u>Terminating</u>
.0008844	.00000000	.0019653	.00000000

Applies to All Exchanges Illinois

FACILITIES FOR INTRASTATE ACCESS

4. SWITCHED ACCESS (Cont'd)

4.4 Rates and Charges – Frontier Communications of the Carolinas (OCN 1000 Exchanges) (Cont'd)

4.4.3 End Office Services (Cont'd)

- (C) End Office Switching - Unbundled (EOSU) - Circuit Switched Line – Non Toll Free (C)
 (C)

The unbundled rates for End Office Switching are based on originating and terminating Access Minutes.

<u>Nonpremium Rates</u>		<u>Premium EOS1 and EOS2 Rates</u>	
<u>Per Access Minute</u>		<u>Per Access Minute</u>	
<u>Originating</u>	<u>Terminating</u>	<u>Originating</u>	<u>Terminating</u>
.0008844	.00000000	.0019653	.00000000

- (D) End Office Switching - Unbundled (EOSU) - Circuit Switched Trunk – Non Toll Free (C)

The unbundled rates for End Office Switching are based on originating and terminating Access Minutes.

<u>Nonpremium Rates</u>		<u>Premium EOS1 and EOS2 Rates</u>	
<u>Per Access Minute</u>		<u>Per Access Minute</u>	
<u>Originating</u>	<u>Terminating</u>	<u>Originating</u>	<u>Terminating</u>
.0008844	.00000000	.0019653	.00000000

Applies to All Exchanges Illinois

FACILITIES FOR INTRASTATE ACCESS

4. SWITCHED ACCESS (Cont'd)

4.4 Rates and Charges – Frontier Communications of the Carolinas (OCN 1000 Exchanges) (Cont'd)

4.4.3 End Office Services (Cont'd)

(E) Shared Trunk Port – Non Toll Free (C)

<u>Per Access Minute</u>	
<u>Originating</u>	<u>Terminating</u>
.0006571	0

(F) End Office Switching - Bundled (EOSB) – Toll Free (N)

The unbundled rates for End Office Switching are based on originating and terminating Access Minutes.

<u>Nonpremium Rates</u>	<u>Premium EOS1 and EOS2 Rates</u>
<u>Per Access Minute</u>	<u>Per Access Minute</u>
<u>Originating</u>	<u>Originating</u>
*	*

(G) End Office Switching - Unbundled (EOSU) - Circuit Switched Line – Toll Free

The unbundled rates for End Office Switching are based on originating Access Minutes.

<u>Nonpremium Rates</u>	<u>Premium EOS1 and EOS2 Rates</u>
<u>Per Access Minute</u>	<u>Per Access Minute</u>
<u>Originating</u>	<u>Originating</u>
*	*

Item 4.4.4 relocated to Sheet No. 55.1

* See Frontier Telephone Companies Tariff FCC No. 5 for Toll Free rates.

Issued: May 11, 2021

Effective: July 1, 2021

By Kenneth Mason
 Vice President
 of Government and Regulatory Affairs

(N)
 (M)
 (N)
 (N)

Applies to All Exchanges Illinois

FACILITIES FOR INTRASTATE ACCESS

4. SWITCHED ACCESS (Cont'd)

4.4 Rates and Charges – Frontier Communications of the Carolinas (OCN 1000 Exchanges) (Cont'd)

4.4.3 End Office Services (Cont'd)

(H) End Office Switching - Unbundled (EOSU) - Circuit Switched Trunk – Toll Free (N)

The unbundled rates for End Office Switching are based on originating Access Minutes.

<u>Nonpremium Rates</u> <u>Per Access Minute</u>	<u>Premium EOS1 and EOS2 Rates</u> <u>Per Access Minute</u>
<u>Originating</u> *	<u>Originating</u> *

(I) Shared Trunk Port – Toll Free

Per Access Minute
Originating
*

4.4.4 Information Surcharge – Non Toll Free and Toll Free (M)(C)

The rates for Information Surcharge are based on originating Access Minutes.

<u>Nonpremium Rates</u> <u>Information Surcharge</u> <u>Per Access Minute</u>	<u>Premium Rates</u> <u>Information Surcharge</u> <u>Per Access Minute</u>
.0000000	.0000000

Item 4.4.4 relocated from Sheet No. 55.

* See Frontier Telephone Companies Tariff FCC No. 5 for Toll Free rates.

Applies to All Exchanges Illinois

FACILITIES FOR INTRASTATE ACCESS

4. SWITCHED ACCESS (Cont'd)

4.4 Rates and Charges – Frontier Communications of the Carolinas
(OCN 1000 Exchanges) (Cont'd)

(C)

4.4.5 FGA or BSA-A Usage Sensitive Credit Allowance

Usage Sensitive Service
Credit Allowance

Credit Per Originating FGA or BSA-A Access Minute #

.00403460

The credit is applied to the End Office Switching rate element.

4.4.6 CCS7 Access Service - Dedicated Switched Access

(A) 56 Kbps Digital Facilities

<u>Dedicated Switched</u> <u>Access Transport</u> (Per Airline Mile) <u>Monthly Rate</u>	<u>Dedicated Switched Access Line</u> Nonrecurring <u>Charge</u> <u>Monthly Rate</u>	
2.50	100.00	66.44

(C)

Issued: June 29, 2012

Effective: July 1, 2012

By Kenneth Mason
 Vice President
 of Government and Regulatory Affairs

Applies to All Exchanges Illinois

FACILITIES FOR INTRASTATE ACCESS

4. SWITCHED ACCESS (Cont'd)

4.4 Rates and Charges – Frontier Communications of the Carolinas
(OCN 1000 Exchanges) (Cont'd)

(C)

4.4.6 CCS7 Access Service - Dedicated Switched Access (Cont'd)

(B) High Capacity Digital DS1 (1.544 Mbps) Facilities

<u>Dedicated Switched</u> <u>Access Transport</u> (Per Airline Mile) <u>Monthly Rate</u>	<u>Dedicated Switched Access Line</u> Nonrecurring <u>Charge</u>	<u>Monthly Rate</u>
40.06	1,500.00	264.94

4.4.7 CCS7 Access Service - STP Port Termination

<u>Nonrecurring</u> <u>Charge</u>	<u>Monthly</u> <u>Rate</u>
43.00	429.97

4.4.8 Reserved

(C)

Applies to All Exchanges Illinois

FACILITIES FOR INTRASTATE ACCESS

4. SWITCHED ACCESS (Cont'd)

4.4 Rates and Charges – Frontier Communications of the Carolinas
(OCN 1000 Exchanges) (Cont'd)

4.4.9 Assumed Minutes of Use Monthly Surrogate

<u>Per Two Way</u> <u>Line/Trunk</u>		<u>Per One Way</u> <u>Line/Trunk</u> <u>Originating</u> <u>Only</u>		<u>Terminating</u> <u>Only</u>	
<u>FGA or</u> <u>BSA-A</u>	<u>FGB or</u> <u>BSA-B</u>	<u>FGA or</u> <u>BSA-A</u>	<u>FGB or</u> <u>BSA-B</u>	<u>FGA or</u> <u>BSA-A</u>	<u>FGB or</u> <u>BSA-B</u>
2,451	(1)	(1)	(1)	13,026	(1)

(1) These s either have all existing services measured or have no customers at this time. In the event an ASR is received for a new customer and there is no measurement capability for the office requested, a traffic study will be made to establish a surrogate and such surrogate will be tarified.

4.4.10 Switched Access Cross Connect

(A) Rates and Charges

<u>DS0</u> <u>Monthly</u> <u>Rate</u>	<u>DS1</u> <u>Monthly</u> <u>Rate</u>	<u>DS3</u> <u>Monthly</u> <u>Rate</u>
1.77	4.53	36.6

(C)

(C)

Issued: June 29, 2012

Effective: July 1, 2012

By Kenneth Mason
 Vice President
 of Government and Regulatory Affairs

Applies to All Exchanges Illinois

FACILITIES FOR INTRASTATE ACCESS

4. SWITCHED ACCESS (Cont'd)

4.4 Rates and Charges – Frontier Communications of the Carolinas
(OCN 1000 Exchanges) (Cont'd)

(C)

4.4.11 Basic Service Elements

(A) Alternate Traffic Routing - BSE

<u>Nonpremium Nonrecurring</u> <u>Charge Per Trunk</u> <u>Group Equipped</u>	<u>Premium Nonrecurring</u> <u>Charge Per Trunk</u> <u>Group Equipped</u>
--	---

27.28

60.6

(B) Automatic Number Identification (ANI) - BSE

Rate
Per ANI Attempt

0.00013

(C) User Transfer - BSE

Monthly Rates
Per Line Arranged

1.50

(C)

Issued: June 29, 2012

Effective: July 1, 2012

By Kenneth Mason
Vice President
of Government and Regulatory Affairs

Applies to All Exchanges Illinois

FACILITIES FOR INTRASTATE ACCESS

4. SWITCHED ACCESS (Cont'd)

4.4 Rates and Charges – Frontier Communications of the Carolinas
(OCN 1000 Exchanges) (Cont'd)

(C)

4.4.11 Basic Service Elements (Cont'd)

(D) Hunt Group Arrangement - BSE

<u>Nonpremium Monthly Rates</u> <u>Per Line Equipped</u>	<u>Premium Monthly Rates</u> <u>Per Line Equipped</u>
1.35	3.00

(E) Queuing - BSE

<u>Nonpremium Monthly Rates</u> <u>Per Group Equipped</u>	<u>Premium Monthly Rates</u> <u>Per Group Equipped</u>
6.75	15.00

(F) Uniform Call Distribution - BSE

<u>Nonpremium Monthly Rates</u> <u>Per Line Equipped</u>	<u>Premium Monthly Rates</u> <u>Per Line Equipped</u>
2.03	4.51

(C)

Applies to All Exchanges Illinois

FACILITIES FOR INTRASTATE ACCESS

4. SWITCHED ACCESS (Cont'd)

4.4 Rates and Charges – Frontier Communications of the Carolinas
(OCN 1000 Exchanges) (Cont'd)

(C)

4.4.11 Basic Service Elements (Cont'd)

(G) Simplified Message Desk Interface (SMDI) - BSE

<u>Nonpremium</u> <u>Monthly Recurring Rate</u> <u>Per DNAL</u>	<u>Premium</u> <u>Monthly Recurring Rate</u> <u>Per DNAL</u>
---	--

88.31

196.25

(H) Premier Messaging Services Interface (PMSI) – BSE

Monthly
Rate

Premier Messaging Services Interface BSE
- Per Arrangement, Per Month

\$500.00

(C)

Issued: June 29, 2012

Effective: July 1, 2012

By Kenneth Mason
Vice President
of Government and Regulatory Affairs

Applies to All Exchanges Illinois

FACILITIES FOR INTRASTATE ACCESS

4. SWITCHED ACCESS (Cont'd)

4.4 Rates and Charges – Frontier Communications of the Carolinas
(OCN 1000 Exchanges) (Cont'd)

(C)

4.4.11 Basic Service Elements (Cont'd)

(I) Signaling System 7 Message Waiting Indicator (SS7MWI)
Signaling Service – BSE

A) Signaling System 7 Message Waiting Indicator (SS7MWI) Sign
Service

Monthly
Rate

SS7MWI Signaling Service \$500.00 per Messaging
Arrangement

(J) Remote Call Forwarding - BSE

<u>Nonpremium</u> <u>Monthly Recurring Rate</u> <u>Per Line</u> <u>(FOMNX)</u>	<u>Premium</u> <u>Monthly Recurring Rate</u> <u>Per Line</u> <u>(FOMPX)</u>
---	--

7.20

16.00

(C)

Issued: June 29, 2012

Effective: July 1, 2012

By Kenneth Mason
Vice President
of Government and Regulatory Affairs

Applies to All Exchanges Illinois

FACILITIES FOR INTRASTATE ACCESS

4. SWITCHED ACCESS (Cont'd)

4.4 Rates and Charges – Frontier Communications of the Carolinas
(OCN 1000 Exchanges) (Cont'd)

(C)

4.4.11 Basic Service Elements (Cont'd)

(K) Direct Inward Dialing (DID) - BSE

<u>Monthly Recurring Rate</u> <u>Per DID Term</u> (NDT)	<u>Monthly Recurring Rate</u> <u>Per Block of 20 Numbers</u> (ND4)
25.00	10.00

(L) Billed Number Screening (BNS) - BSE

Monthly Recurring Rate
Per Line Screened
(RTVXQ)

1.00

4.4.12 Carrier Identification Parameter (CIP)

<u>Non-Recurring</u> <u>Charge-Per CIC,</u> <u>Per End Office</u> <u>Direct Trunk</u> <u>Group</u>	<u>Non-Recurring</u> <u>Charge Per CIC,</u> <u>Per Access Tandem</u> <u>Direct Trunk</u> <u>Group</u>	<u>Monthly Recurring</u> <u>Charges</u> <u>Per Trunk</u>
80.00	1,120.00	.46

(C)

Issued: June 29, 2012

Effective: July 1, 2012

By Kenneth Mason
 Vice President
 of Government and Regulatory Affairs

Applies to All Exchanges Illinois

FACILITIES FOR INTRASTATE ACCESS

4. RESERVED FOR FUTURE USE

(D)

(D)

Issued: June 29, 2012

Effective: July 1, 2012

By Kenneth Mason
Vice President
Of Government and Regulatory Affairs

Frontier North Inc.

Ill. C. C. No. 15

Applies to All Exchanges Illinois

FACILITIES FOR INTRASTATE ACCESS

4. RESERVED FOR FUTURE USE (Cont'd)

(D)

(D)

Issued: June 29, 2012

Effective: July 1, 2012

By Kenneth Mason
Vice President
Of Government and Regulatory Affairs

Frontier North Inc.

Ill. C. C. No. 15

Applies to All Exchanges Illinois

FACILITIES FOR INTRASTATE ACCESS

4. RESERVED FOR FUTURE USE (Cont'd)

(D)

(D)

Issued: June 29, 2012

Effective: July 1, 2012

By Kenneth Mason
Vice President
Of Government and Regulatory Affairs

Frontier North Inc.

Ill. C. C. No. 15

Applies to All Exchanges Illinois

FACILITIES FOR INTRASTATE ACCESS

4. RESERVED FOR FUTURE USE (Cont'd)

(D)

(D)

Issued: June 29, 2012

Effective: July 1, 2012

By Kenneth Mason
Vice President
Of Government and Regulatory Affairs

Frontier North Inc.

Ill. C. C. No. 15

Applies to All Exchanges Illinois

FACILITIES FOR INTRASTATE ACCESS

4. RESERVED FOR FUTURE USE (Cont'd)

(D)

(D)

Issued: June 29, 2012

Effective: July 1, 2012

By Kenneth Mason
Vice President
Of Government and Regulatory Affairs

Frontier North Inc.

Ill. C. C. No. 15

Applies to All Exchanges Illinois

FACILITIES FOR INTRASTATE ACCESS

4. RESERVED FOR FUTURE USE (Cont'd)

(D)

(D)

Issued: June 29, 2012

Effective: July 1, 2012

By Kenneth Mason
Vice President
Of Government and Regulatory Affairs

Frontier North Inc.

Ill. C. C. No. 15

Applies to All Exchanges Illinois

FACILITIES FOR INTRASTATE ACCESS

4. RESERVED FOR FUTURE USE (Cont'd)

(D)

(D)

Applies to All Exchanges Illinois

FACILITIES FOR INTRASTATE ACCESS

4. RESERVED FOR FUTURE USE (Cont'd)

(D)

(D)

Applies to All Exchanges Illinois

FACILITIES FOR INTRASTATE ACCESS

4. RESERVED FOR FUTURE USE (Cont'd)

(D)

(D)

Applies to All Exchanges Illinois

FACILITIES FOR INTRASTATE ACCESS

4. RESERVED FOR FUTURE USE (Cont'd)

(D)

(D)

Applies to All Exchanges Illinois

FACILITIES FOR INTRASTATE ACCESS

4. RESERVED FOR FUTURE USE (Cont'd)

(D)

(D)

Applies to All Exchanges Illinois

FACILITIES FOR INTRASTATE ACCESS

4. RESERVED FOR FUTURE USE (Cont'd)

(D)

(D)

Applies to All Exchanges Illinois

FACILITIES FOR INTRASTATE ACCESS

4. RESERVED FOR FUTURE USE (Cont'd)

(D)

(D)

Applies to All Exchanges Illinois

FACILITIES FOR INTRASTATE ACCESS

4. RESERVED FOR FUTURE USE (Cont'd)

(D)

(D)

Applies to All Exchanges Illinois

FACILITIES FOR INTRASTATE ACCESS

4. RESERVED FOR FUTURE USE (Cont'd)

(D)

(D)

Applies to All Exchanges Illinois

FACILITIES FOR INTRASTATE ACCESS

4. RESERVED FOR FUTURE USE (Cont'd)

(D)

(D)

Applies to All Exchanges Illinois

FACILITIES FOR INTRASTATE ACCESS

4. RESERVED FOR FUTURE USE (Cont'd)

(D)

(D)

Applies to All Exchanges Illinois

FACILITIES FOR INTRASTATE ACCESS

4. RESERVED FOR FUTURE USE (Cont'd)

(D)

(D)

Applies to All Exchanges Illinois

FACILITIES FOR INTRASTATE ACCESS

4. RESERVED FOR FUTURE USE (Cont'd)

(D)

(D)

Applies to All Exchanges Illinois

FACILITIES FOR INTRASTATE ACCESS

4. RESERVED FOR FUTURE USE (Cont'd)

(D)

(D)

Applies to All Exchanges Illinois

FACILITIES FOR INTRASTATE ACCESS

4. RESERVED FOR FUTURE USE (Cont'd)

(D)

(D)

Applies to All Exchanges Illinois

FACILITIES FOR INTRASTATE ACCESS

4. RESERVED FOR FUTURE USE (Cont'd)

(D)

(D)

Applies to All Exchanges Illinois

FACILITIES FOR INTRASTATE ACCESS

4. RESERVED FOR FUTURE USE (Cont'd)

(D)

(D)

Applies to All Exchanges Illinois

FACILITIES FOR INTRASTATE ACCESS

4. RESERVED FOR FUTURE USE (Cont'd)

(D)

(D)

Applies to All Exchanges Illinois

FACILITIES FOR INTRASTATE ACCESS

4. RESERVED FOR FUTURE USE (Cont'd)

(D)

(D)

Issued: June 29, 2012

Effective: July 1, 2012

By Kenneth Mason
Vice President
Of Government and Regulatory Affairs

Applies to All Exchanges Illinois

FACILITIES FOR INTRASTATE ACCESS

4. RESERVED FOR FUTURE USE (Cont'd)

(D)

(D)

Issued: June 29, 2012

Effective: July 1, 2012

By Kenneth Mason
Vice President
Of Government and Regulatory Affairs

Applies to All Exchanges Illinois

FACILITIES FOR INTRASTATE ACCESS

4. RESERVED FOR FUTURE USE (Cont'd)

(D)

(D)

Applies to All Exchanges Illinois

FACILITIES FOR INTRASTATE ACCESS

4. RESERVED FOR FUTURE USE (Cont'd)

(D)

(D)

Applies to All Exchanges Illinois

FACILITIES FOR INTRASTATE ACCESS

4. RESERVED FOR FUTURE USE (Cont'd)

(D)

(D)

Issued: June 29, 2012

Effective: July 1, 2012

By Kenneth Mason
Vice President
Of Government and Regulatory Affairs

Applies to All Exchanges Illinois

FACILITIES FOR INTRASTATE ACCESS

4. RESERVED FOR FUTURE USE (Cont'd)

(D)

(D)

Applies to All Exchanges Illinois

FACILITIES FOR INTRASTATE ACCESS

4. RESERVED FOR FUTURE USE (Cont'd)

(D)

(D)

Applies to All Exchanges Illinois

FACILITIES FOR INTRASTATE ACCESS

4. RESERVED FOR FUTURE USE (Cont'd)

(D)

(D)

Applies to All Exchanges Illinois

FACILITIES FOR INTRASTATE ACCESS

4. RESERVED FOR FUTURE USE (Cont'd)

(D)

(D)

Applies to All Exchanges Illinois

FACILITIES FOR INTRASTATE ACCESS

4. RESERVED FOR FUTURE USE (Cont'd)

(D)

(D)

Applies to All Exchanges Illinois

FACILITIES FOR INTRASTATE ACCESS

4. RESERVED FOR FUTURE USE (Cont'd)

(D)

(D)

Issued: June 29, 2012

Effective: July 1, 2012

By Kenneth Mason
Vice President
Of Government and Regulatory Affairs

Applies to All Exchanges Illinois

FACILITIES FOR INTRASTATE ACCESS

4. RESERVED FOR FUTURE USE (Cont'd)

(D)

(D)

Issued: June 29, 2012

Effective: July 1, 2012

By Kenneth Mason
Vice President
Of Government and Regulatory Affairs

Applies to All Exchanges Illinois

FACILITIES FOR INTRASTATE ACCESS

4. RESERVED FOR FUTURE USE (Cont'd)

(D)

(D)

Applies to All Exchanges Illinois

FACILITIES FOR INTRASTATE ACCESS

4. RESERVED FOR FUTURE USE (Cont'd)

(D)

(D)

Applies to All Exchanges Illinois

FACILITIES FOR INTRASTATE ACCESS

4. RESERVED FOR FUTURE USE (Cont'd)

(D)

(D)

Applies to All Exchanges Illinois

FACILITIES FOR INTRASTATE ACCESS

4. RESERVED FOR FUTURE USE (Cont'd)

(D)

(D)

Applies to All Exchanges Illinois

FACILITIES FOR INTRASTATE ACCESS

4. RESERVED FOR FUTURE USE (Cont'd)

(D)

(D)

Applies to All Exchanges Illinois

FACILITIES FOR INTRASTATE ACCESS

4. RESERVED FOR FUTURE USE (Cont'd)

(D)

(D)

Applies to All Exchanges Illinois

FACILITIES FOR INTRASTATE ACCESS

4. RESERVED FOR FUTURE USE (Cont'd)

(D)

(D)

Issued: June 29, 2012

Effective: July 1, 2012

By Kenneth Mason
Vice President
Of Government and Regulatory Affairs

Applies to All Exchanges Illinois

FACILITIES FOR INTRASTATE ACCESS

4. RESERVED FOR FUTURE USE (Cont'd)

(D)

(D)

Applies to All Exchanges Illinois

FACILITIES FOR INTRASTATE ACCESS

4. RESERVED FOR FUTURE USE (Cont'd)

(D)

(D)

Issued: June 29, 2012

Effective: July 1, 2012

By Kenneth Mason
Vice President
Of Government and Regulatory Affairs

Applies to All Exchanges Illinois

FACILITIES FOR INTRASTATE ACCESS

4. RESERVED FOR FUTURE USE (Cont'd)

(D)

(D)

Applies to All Exchanges Illinois

FACILITIES FOR INTRASTATE ACCESS

4. RESERVED FOR FUTURE USE (Cont'd)

(D)

(D)

Applies to All Exchanges Illinois

FACILITIES FOR INTRASTATE ACCESS

4. RESERVED FOR FUTURE USE (Cont'd)

(D)

(D)

Applies to All Exchanges Illinois

FACILITIES FOR INTRASTATE ACCESS

4. RESERVED FOR FUTURE USE (Cont'd)

(D)

(D)

Applies to All Exchanges Illinois

FACILITIES FOR INTRASTATE ACCESS

4. RESERVED FOR FUTURE USE (Cont'd)

(D)

(D)

Applies to All Exchanges Illinois

FACILITIES FOR INTRASTATE ACCESS

4. RESERVED FOR FUTURE USE (Cont'd)

(D)

(D)

Applies to All Exchanges Illinois

FACILITIES FOR INTRASTATE ACCESS

4. RESERVED FOR FUTURE USE (Cont'd)

(D)

(D)

Issued: June 29, 2012

Effective: July 1, 2012

By Kenneth Mason
Vice President
Of Government and Regulatory Affairs

Applies to All Exchanges Illinois

FACILITIES FOR INTRASTATE ACCESS

4. RESERVED FOR FUTURE USE (Cont'd)

(D)

(D)

Issued: June 29, 2012

Effective: July 1, 2012

By Kenneth Mason
Vice President
Of Government and Regulatory Affairs

Applies to All Exchanges Illinois

FACILITIES FOR INTRASTATE ACCESS

4. RESERVED FOR FUTURE USE (Cont'd)

(D)

(D)

Applies to All Exchanges Illinois

FACILITIES FOR INTRASTATE ACCESS

4. RESERVED FOR FUTURE USE (Cont'd)

(D)

(D)

Applies to All Exchanges Illinois

FACILITIES FOR INTRASTATE ACCESS

4. RESERVED FOR FUTURE USE (Cont'd)

(D)

(D)

Issued: June 29, 2012

Effective: July 1, 2012

By Kenneth Mason
Vice President
Of Government and Regulatory Affairs

Applies to All Exchanges Illinois

FACILITIES FOR INTRASTATE ACCESS

4. RESERVED FOR FUTURE USE (Cont'd)

(D)

(D)

Issued: June 29, 2012

Effective: July 1, 2012

By Kenneth Mason
Vice President
Of Government and Regulatory Affairs

Applies to All Exchanges Illinois

FACILITIES FOR INTRASTATE ACCESS

4. RESERVED FOR FUTURE USE (Cont'd)

(D)

(D)

Issued: June 29, 2012

Effective: July 1, 2012

By Kenneth Mason
Vice President
Of Government and Regulatory Affairs

Applies to All Exchanges Illinois

FACILITIES FOR INTRASTATE ACCESS

4. RESERVED FOR FUTURE USE (Cont'd)

(D)

(D)

Issued: June 29, 2012

Effective: July 1, 2012

By Kenneth Mason
Vice President
Of Government and Regulatory Affairs

Applies to All Exchanges Illinois

FACILITIES FOR INTRASTATE ACCESS

4. RESERVED FOR FUTURE USE (Cont'd)

(D)

(D)

Issued: June 29, 2012

Effective: July 1, 2012

By Kenneth Mason
Vice President
Of Government and Regulatory Affairs

Applies to All Exchanges Illinois

FACILITIES FOR INTRASTATE ACCESS

4. RESERVED FOR FUTURE USE (Cont'd)

(D)

(D)

Applies to All Exchanges Illinois

FACILITIES FOR INTRASTATE ACCESS

4. RESERVED FOR FUTURE USE (Cont'd)

(D)

(D)

Applies to All Exchanges Illinois

FACILITIES FOR INTRASTATE ACCESS

4. RESERVED FOR FUTURE USE (Cont'd)

(D)

(D)

Applies to All Exchanges Illinois

FACILITIES FOR INTRASTATE ACCESS

4. RESERVED FOR FUTURE USE (Cont'd)

(D)

(D)

Applies to All Exchanges Illinois

FACILITIES FOR INTRASTATE ACCESS

4. RESERVED FOR FUTURE USE (Cont'd)

(D)

(D)

Applies to All Exchanges Illinois

FACILITIES FOR INTRASTATE ACCESS

4. RESERVED FOR FUTURE USE (Cont'd)

(D)

(D)

Applies to All Exchanges Illinois

FACILITIES FOR INTRASTATE ACCESS

4. RESERVED FOR FUTURE USE (Cont'd)

(D)

(D)

Applies to All Exchanges Illinois

FACILITIES FOR INTRASTATE ACCESS

4. RESERVED FOR FUTURE USE (Cont'd)

(D)

(D)

Issued: June 29, 2012

Effective: July 1, 2012

By Kenneth Mason
Vice President
Of Government and Regulatory Affairs

Applies to All Exchanges Illinois

FACILITIES FOR INTRASTATE ACCESS

4. RESERVED FOR FUTURE USE (Cont'd)

(D)

(D)

Applies to All Exchanges Illinois

FACILITIES FOR INTRASTATE ACCESS

4. RESERVED FOR FUTURE USE (Cont'd)

(D)

(D)

Issued: June 29, 2012

Effective: July 1, 2012

By Kenneth Mason
Vice President
Of Government and Regulatory Affairs

Applies to All Exchanges Illinois

FACILITIES FOR INTRASTATE ACCESS

4. RESERVED FOR FUTURE USE (Cont'd)

(D)

(D)

Applies to All Exchanges Illinois

FACILITIES FOR INTRASTATE ACCESS

4. RESERVED FOR FUTURE USE (Cont'd)

(D)

(D)

Applies to All Exchanges Illinois

FACILITIES FOR INTRASTATE ACCESS

4. RESERVED FOR FUTURE USE (Cont'd)

(D)

(D)

Applies to All Exchanges Illinois

FACILITIES FOR INTRASTATE ACCESS

4. RESERVED FOR FUTURE USE (Cont'd)

(D)

(D)

Applies to All Exchanges Illinois

FACILITIES FOR INTRASTATE ACCESS

4. RESERVED FOR FUTURE USE (Cont'd)

(D)

(D)

Applies to All Exchanges Illinois

FACILITIES FOR INTRASTATE ACCESS

4. RESERVED FOR FUTURE USE (Cont'd)

(D)

(D)

Applies to All Exchanges Illinois

FACILITIES FOR INTRASTATE ACCESS

4. RESERVED FOR FUTURE USE (Cont'd)

(D)

(D)

Applies to All Exchanges Illinois

FACILITIES FOR INTRASTATE ACCESS

4. RESERVED FOR FUTURE USE (Cont'd)

(D)

(D)

Applies to All Exchanges Illinois

FACILITIES FOR INTRASTATE ACCESS

4. RESERVED FOR FUTURE USE (Cont'd)

(D)

(D)

Applies to All Exchanges Illinois

FACILITIES FOR INTRASTATE ACCESS

4. RESERVED FOR FUTURE USE (Cont'd)

(D)

(D)

Applies to All Exchanges Illinois

FACILITIES FOR INTRASTATE ACCESS

4. RESERVED FOR FUTURE USE (Cont'd)

(D)

(D)

Applies to All Exchanges Illinois

FACILITIES FOR INTRASTATE ACCESS

4. RESERVED FOR FUTURE USE (Cont'd)

(D)

(D)

Applies to All Exchanges Illinois

FACILITIES FOR INTRASTATE ACCESS

4. RESERVED FOR FUTURE USE (Cont'd)

(D)

(D)

Applies to All Exchanges Illinois

FACILITIES FOR INTRASTATE ACCESS

4. RESERVED FOR FUTURE USE (Cont'd)

(D)

(D)

Applies to All Exchanges Illinois

FACILITIES FOR INTRASTATE ACCESS

4. RESERVED FOR FUTURE USE (Cont'd)

(D)

(D)

Applies to All Exchanges Illinois

FACILITIES FOR INTRASTATE ACCESS

4. RESERVED FOR FUTURE USE (Cont'd)

(D)

(D)

Applies to All Exchanges Illinois

FACILITIES FOR INTRASTATE ACCESS

4. RESERVED FOR FUTURE USE (Cont'd)

(D)

(D)

Applies to All Exchanges Illinois

FACILITIES FOR INTRASTATE ACCESS

4. RESERVED FOR FUTURE USE (Cont'd)

(D)

(D)

Applies to All Exchanges Illinois

FACILITIES FOR INTRASTATE ACCESS

4. RESERVED FOR FUTURE USE (Cont'd)

(D)

(D)

Applies to All Exchanges Illinois

FACILITIES FOR INTRASTATE ACCESS

4. RESERVED FOR FUTURE USE (Cont'd)

(D)

(D)

Applies to All Exchanges Illinois

FACILITIES FOR INTRASTATE ACCESS

4. RESERVED FOR FUTURE USE (Cont'd)

(D)

(D)

Applies to All Exchanges Illinois

FACILITIES FOR INTRASTATE ACCESS

4. RESERVED FOR FUTURE USE (Cont'd)

(D)

(D)

Applies to All Exchanges Illinois

FACILITIES FOR INTRASTATE ACCESS

4. RESERVED FOR FUTURE USE (Cont'd)

(D)

(D)

Applies to All Exchanges Illinois

FACILITIES FOR INTRASTATE ACCESS

4. RESERVED FOR FUTURE USE (Cont'd)

(D)

(D)

Applies to All Exchanges Illinois

FACILITIES FOR INTRASTATE ACCESS

4. RESERVED FOR FUTURE USE (Cont'd)

(D)

(D)

Applies to All Exchanges Illinois

FACILITIES FOR INTRASTATE ACCESS

4. RESERVED FOR FUTURE USE (Cont'd)

(D)

(D)

Applies to All Exchanges Illinois

FACILITIES FOR INTRASTATE ACCESS

4. RESERVED FOR FUTURE USE (Cont'd)

(D)

(D)

Applies to All Exchanges Illinois

FACILITIES FOR INTRASTATE ACCESS

4. RESERVED FOR FUTURE USE (Cont'd)

(D)

(D)

Issued: June 29, 2012

Effective: July 1, 2012

By Kenneth Mason
Vice President
Of Government and Regulatory Affairs

Applies to All Exchanges Illinois

FACILITIES FOR INTRASTATE ACCESS

4. RESERVED FOR FUTURE USE (Cont'd)

(D)

(D)

Applies to All Exchanges Illinois

FACILITIES FOR INTRASTATE ACCESS

4. RESERVED FOR FUTURE USE (Cont'd)

(D)

(D)

Issued: June 29, 2012

Effective: July 1, 2012

By Kenneth Mason
Vice President
Of Government and Regulatory Affairs

Applies to All Exchanges Illinois

FACILITIES FOR INTRASTATE ACCESS

4. RESERVED FOR FUTURE USE (Cont'd)

(D)

(D)

Issued: June 29, 2012

Effective: July 1, 2012

By Kenneth Mason
Vice President
Of Government and Regulatory Affairs

Applies to All Exchanges Illinois

FACILITIES FOR INTRASTATE ACCESS

4. RESERVED FOR FUTURE USE (Cont'd)

(D)

(D)

Issued: June 29, 2012

Effective: July 1, 2012

By Kenneth Mason
Vice President
Of Government and Regulatory Affairs

Applies to All Exchanges Illinois

FACILITIES FOR INTRASTATE ACCESS

4. RESERVED FOR FUTURE USE (Cont'd)

(D)

(D)

Issued: June 29, 2012

Effective: July 1, 2012

By Kenneth Mason
Vice President
Of Government and Regulatory Affairs

Applies to All Exchanges Illinois

FACILITIES FOR INTRASTATE ACCESS

4. RESERVED FOR FUTURE USE (Cont'd)

(D)

(D)

Applies to All Exchanges Illinois

FACILITIES FOR INTRASTATE ACCESS

4. RESERVED FOR FUTURE USE (Cont'd)

(D)

(D)

Applies to All Exchanges Illinois

FACILITIES FOR INTRASTATE ACCESS

4. RESERVED FOR FUTURE USE (Cont'd)

(D)

(D)

Issued: June 29, 2012

Effective: July 1, 2012

By Kenneth Mason
Vice President
Of Government and Regulatory Affairs

Applies to All Exchanges Illinois

FACILITIES FOR INTRASTATE ACCESS

4. RESERVED FOR FUTURE USE (Cont'd)

(D)

(D)

Applies to All Exchanges Illinois

FACILITIES FOR INTRASTATE ACCESS

4. RESERVED FOR FUTURE USE (Cont'd)

(D)

(D)

Issued: June 29, 2012

Effective: July 1, 2012

By Kenneth Mason
Vice President
Of Government and Regulatory Affairs

Applies to All Exchanges Illinois

FACILITIES FOR INTRASTATE ACCESS

4. RESERVED FOR FUTURE USE (Cont'd)

(D)

(D)

Issued: June 29, 2012

Effective: July 1, 2012

By Kenneth Mason
Vice President
Of Government and Regulatory Affairs

Applies to All Exchanges Illinois

FACILITIES FOR INTRASTATE ACCESS

4. RESERVED FOR FUTURE USE (Cont'd)

(D)

(D)

Issued: June 29, 2012

Effective: July 1, 2012

By Kenneth Mason
Vice President
Of Government and Regulatory Affairs

Applies to All Exchanges Illinois

FACILITIES FOR INTRASTATE ACCESS

4. RESERVED FOR FUTURE USE (Cont'd)

(D)

(D)

Applies to All Exchanges Illinois

FACILITIES FOR INTRASTATE ACCESS

4. RESERVED FOR FUTURE USE (Cont'd)

(D)

(D)

Issued: June 29, 2012

Effective: July 1, 2012

By Kenneth Mason
Vice President
Of Government and Regulatory Affairs

Applies to All Exchanges Illinois

FACILITIES FOR INTRASTATE ACCESS

4. RESERVED FOR FUTURE USE (Cont'd)

(D)

(D)

Applies to All Exchanges Illinois

FACILITIES FOR INTRASTATE ACCESS

4. RESERVED FOR FUTURE USE (Cont'd)

(D)

(D)

Applies to All Exchanges Illinois

FACILITIES FOR INTRASTATE ACCESS

4. RESERVED FOR FUTURE USE (Cont'd)

(D)

(D)

Issued: June 29, 2012

Effective: July 1, 2012

By Kenneth Mason
Vice President
Of Government and Regulatory Affairs

Applies to All Exchanges Illinois

FACILITIES FOR INTRASTATE ACCESS

4. RESERVED FOR FUTURE USE (Cont'd)

(D)

(D)

Issued: June 29, 2012

Effective: July 1, 2012

By Kenneth Mason
Vice President
Of Government and Regulatory Affairs

Applies to All Exchanges Illinois

FACILITIES FOR INTRASTATE ACCESS

4. RESERVED FOR FUTURE USE (Cont'd)

(D)

(D)

Issued: June 29, 2012

Effective: July 1, 2012

By Kenneth Mason
Vice President
Of Government and Regulatory Affairs

Applies to All Exchanges Illinois

FACILITIES FOR INTRASTATE ACCESS

4. RESERVED FOR FUTURE USE (Cont'd)

(D)

(D)

Issued: June 29, 2012

Effective: July 1, 2012

By Kenneth Mason
Vice President
Of Government and Regulatory Affairs

Applies to All Exchanges Illinois

FACILITIES FOR INTRASTATE ACCESS

4. RESERVED FOR FUTURE USE (Cont'd)

(D)

(D)

Issued: June 29, 2012

Effective: July 1, 2012

By Kenneth Mason
Vice President
Of Government and Regulatory Affairs

Applies to All Exchanges Illinois

FACILITIES FOR INTRASTATE ACCESS

4. RESERVED FOR FUTURE USE (Cont'd)

(D)

(D)

Issued: June 29, 2012

Effective: July 1, 2012

By Kenneth Mason
Vice President
Of Government and Regulatory Affairs

Applies to All Exchanges Illinois

FACILITIES FOR INTRASTATE ACCESS

4. RESERVED FOR FUTURE USE (Cont'd)

(D)

(D)

Issued: June 29, 2012

Effective: July 1, 2012

By Kenneth Mason
Vice President
Of Government and Regulatory Affairs

Applies to All Exchanges Illinois

FACILITIES FOR INTRASTATE ACCESS

4. RESERVED FOR FUTURE USE (Cont'd)

(D)

(D)

Issued: June 29, 2012

Effective: July 1, 2012

By Kenneth Mason
Vice President
Of Government and Regulatory Affairs

Applies to All Exchanges Illinois

FACILITIES FOR INTRASTATE ACCESS

4. RESERVED FOR FUTURE USE (Cont'd)

(D)

(D)

Issued: June 29, 2012

Effective: July 1, 2012

By Kenneth Mason
Vice President
Of Government and Regulatory Affairs

Applies to All Exchanges Illinois

FACILITIES FOR INTRASTATE ACCESS

4. RESERVED FOR FUTURE USE (Cont'd)

(D)

(D)

Issued: June 29, 2012

Effective: July 1, 2012

By Kenneth Mason
Vice President
Of Government and Regulatory Affairs

Applies to All Exchanges Illinois

FACILITIES FOR INTRASTATE ACCESS

4. RESERVED FOR FUTURE USE (Cont'd)

(D)

(D)

Issued: June 29, 2012

Effective: July 1, 2012

By Kenneth Mason
Vice President
Of Government and Regulatory Affairs

Applies to All Exchanges Illinois

FACILITIES FOR INTRASTATE ACCESS

4. RESERVED FOR FUTURE USE (Cont'd)

(D)

(D)

Issued: June 29, 2012

Effective: July 1, 2012

By Kenneth Mason
Vice President
Of Government and Regulatory Affairs

Applies to All Exchanges Illinois

FACILITIES FOR INTRASTATE ACCESS

4. RESERVED FOR FUTURE USE (Cont'd)

(D)

(D)

Issued: June 29, 2012

Effective: July 1, 2012

By Kenneth Mason
Vice President
Of Government and Regulatory Affairs

Applies to All Exchanges Illinois

FACILITIES FOR INTRASTATE ACCESS

4. RESERVED FOR FUTURE USE (Cont'd)

(D)

(D)

Issued: June 29, 2012

Effective: July 1, 2012

By Kenneth Mason
Vice President
Of Government and Regulatory Affairs

Applies to All Exchanges Illinois

FACILITIES FOR INTRASTATE ACCESS

4. RESERVED FOR FUTURE USE (Cont'd)

(D)

(D)

Issued: June 29, 2012

Effective: July 1, 2012

By Kenneth Mason
Vice President
Of Government and Regulatory Affairs

Applies to All Exchanges Illinois

FACILITIES FOR INTRASTATE ACCESS

4. RESERVED FOR FUTURE USE (Cont'd)

(D)

(D)

Applies to All Exchanges Illinois

FACILITIES FOR INTRASTATE ACCESS

4. RESERVED FOR FUTURE USE (Cont'd)

(D)

(D)

Applies to All Exchanges Illinois

FACILITIES FOR INTRASTATE ACCESS

4. RESERVED FOR FUTURE USE (Cont'd)

(D)

(D)

Applies to All Exchanges Illinois

FACILITIES FOR INTRASTATE ACCESS

4. RESERVED FOR FUTURE USE (Cont'd)

(D)

(D)

Applies to All Exchanges Illinois

FACILITIES FOR INTRASTATE ACCESS

4. RESERVED FOR FUTURE USE (Cont'd)

(D)

(D)

Applies to All Exchanges Illinois

FACILITIES FOR INTRASTATE ACCESS

4. RESERVED FOR FUTURE USE (Cont'd)

(D)

(D)

Applies to All Exchanges Illinois

FACILITIES FOR INTRASTATE ACCESS

4. RESERVED FOR FUTURE USE (Cont'd)

(D)

(D)

Applies to All Exchanges Illinois

FACILITIES FOR INTRASTATE ACCESS

4. RESERVED FOR FUTURE USE (Cont'd)

(D)

(D)

Applies to All Exchanges Illinois

FACILITIES FOR INTRASTATE ACCESS

4. RESERVED FOR FUTURE USE (Cont'd)

(D)

(D)

Issued: June 29, 2012

Effective: July 1, 2012

By Kenneth Mason
Vice President
Of Government and Regulatory Affairs

Applies to All Exchanges Illinois

FACILITIES FOR INTRASTATE ACCESS

4. RESERVED FOR FUTURE USE (Cont'd)

(D)

(D)

Issued: June 29, 2012

Effective: July 1, 2012

By Kenneth Mason
Vice President
Of Government and Regulatory Affairs

Applies to All Exchanges Illinois

FACILITIES FOR INTRASTATE ACCESS

4. RESERVED FOR FUTURE USE (Cont'd)

(D)

(D)

Issued: June 29, 2012

Effective: July 1, 2012

By Kenneth Mason
Vice President
Of Government and Regulatory Affairs

Applies to All Exchanges Illinois

FACILITIES FOR INTRASTATE ACCESS

4. RESERVED FOR FUTURE USE (Cont'd)

(D)

(D)

Issued: June 29, 2012

Effective: July 1, 2012

By Kenneth Mason
Vice President
Of Government and Regulatory Affairs

Applies to All Exchanges Illinois

FACILITIES FOR INTRASTATE ACCESS

4. RESERVED FOR FUTURE USE (Cont'd)

(D)

(D)

Issued: June 29, 2012

Effective: July 1, 2012

By Kenneth Mason
Vice President
Of Government and Regulatory Affairs

Applies to All Exchanges Illinois

FACILITIES FOR INTRASTATE ACCESS

4. RESERVED FOR FUTURE USE (Cont'd)

(D)

(D)

Issued: June 29, 2012

Effective: July 1, 2012

By Kenneth Mason
Vice President
Of Government and Regulatory Affairs

Applies to All Exchanges Illinois

FACILITIES FOR INTRASTATE ACCESS

4. RESERVED FOR FUTURE USE (Cont'd)

(D)

(D)

Applies to All Exchanges Illinois

FACILITIES FOR INTRASTATE ACCESS

4. RESERVED FOR FUTURE USE (Cont'd)

(D)

(D)

Issued: June 29, 2012

Effective: July 1, 2012

By Kenneth Mason
Vice President
Of Government and Regulatory Affairs

Applies to All Exchanges Illinois

FACILITIES FOR INTRASTATE ACCESS

4. RESERVED FOR FUTURE USE (Cont'd)

(D)

(D)

Issued: June 29, 2012

Effective: July 1, 2012

By Kenneth Mason
Vice President
Of Government and Regulatory Affairs

Applies to All Exchanges Illinois

FACILITIES FOR INTRASTATE ACCESS

4. RESERVED FOR FUTURE USE (Cont'd)

(D)

(D)

Issued: June 29, 2012

Effective: July 1, 2012

By Kenneth Mason
Vice President
Of Government and Regulatory Affairs

Applies to All Exchanges Illinois

FACILITIES FOR INTRASTATE ACCESS

4. RESERVED FOR FUTURE USE (Cont'd)

(D)

(D)

Issued: June 29, 2012

Effective: July 1, 2012

By Kenneth Mason
Vice President
Of Government and Regulatory Affairs

Applies to All Exchanges Illinois

FACILITIES FOR INTRASTATE ACCESS

4. RESERVED FOR FUTURE USE (Cont'd)

(D)

(D)

Issued: June 29, 2012

Effective: July 1, 2012

By Kenneth Mason
Vice President
Of Government and Regulatory Affairs

Applies to All Exchanges Illinois

FACILITIES FOR INTRASTATE ACCESS

4. RESERVED FOR FUTURE USE (Cont'd)

(D)

(D)

Issued: June 29, 2012

Effective: July 1, 2012

By Kenneth Mason
Vice President
Of Government and Regulatory Affairs

Applies to All Exchanges Illinois

FACILITIES FOR INTRASTATE ACCESS

4. RESERVED FOR FUTURE USE (Cont'd)

(D)

(D)

Issued: June 29, 2012

Effective: July 1, 2012

By Kenneth Mason
Vice President
Of Government and Regulatory Affairs

Applies to All Exchanges Illinois

FACILITIES FOR INTRASTATE ACCESS

4. RESERVED FOR FUTURE USE (Cont'd)

(D)

(D)

Issued: June 29, 2012

Effective: July 1, 2012

By Kenneth Mason
Vice President
Of Government and Regulatory Affairs

Applies to All Exchanges Illinois

FACILITIES FOR INTRASTATE ACCESS

4. RESERVED FOR FUTURE USE (Cont'd)

(D)

(D)

Issued: June 29, 2012

Effective: July 1, 2012

By Kenneth Mason
Vice President
Of Government and Regulatory Affairs

Applies to All Exchanges Illinois

FACILITIES FOR INTRASTATE ACCESS

4. RESERVED FOR FUTURE USE (Cont'd)

(D)

(D)

Issued: June 29, 2012

Effective: July 1, 2012

By Kenneth Mason
Vice President
Of Government and Regulatory Affairs

Applies to All Exchanges Illinois

FACILITIES FOR INTRASTATE ACCESS

4. RESERVED FOR FUTURE USE (Cont'd)

(D)

(D)

Issued: June 29, 2012

Effective: July 1, 2012

By Kenneth Mason
Vice President
Of Government and Regulatory Affairs

Applies to All Exchanges Illinois

FACILITIES FOR INTRASTATE ACCESS

4. RESERVED FOR FUTURE USE (Cont'd)

(D)

(D)

Issued: June 29, 2012

Effective: July 1, 2012

By Kenneth Mason
Vice President
Of Government and Regulatory Affairs

Applies to All Exchanges Illinois

FACILITIES FOR INTRASTATE ACCESS

4. RESERVED FOR FUTURE USE (Cont'd)

(D)

(D)

Issued: June 29, 2012

Effective: July 1, 2012

By Kenneth Mason
Vice President
Of Government and Regulatory Affairs

Applies to All Exchanges Illinois

FACILITIES FOR INTRASTATE ACCESS

4. RESERVED FOR FUTURE USE (Cont'd)

(D)

(D)

Issued: June 29, 2012

Effective: July 1, 2012

By Kenneth Mason
Vice President
Of Government and Regulatory Affairs

Applies to All Exchanges Illinois

FACILITIES FOR INTRASTATE ACCESS

4. RESERVED FOR FUTURE USE (Cont'd)

(D)

(D)

Issued: June 29, 2012

Effective: July 1, 2012

By Kenneth Mason
Vice President
Of Government and Regulatory Affairs

Applies to All Exchanges Illinois

FACILITIES FOR INTRASTATE ACCESS

4. RESERVED FOR FUTURE USE (Cont'd)

(D)

(D)

Issued: June 29, 2012

Effective: July 1, 2012

By Kenneth Mason
Vice President
Of Government and Regulatory Affairs

Applies to All Exchanges Illinois

FACILITIES FOR INTRASTATE ACCESS

4. RESERVED FOR FUTURE USE (Cont'd)

(D)

(D)

Issued: June 29, 2012

Effective: July 1, 2012

By Kenneth Mason
Vice President
Of Government and Regulatory Affairs

Applies to All Exchanges Illinois

FACILITIES FOR INTRASTATE ACCESS

4. RESERVED FOR FUTURE USE (Cont'd)

(D)

(D)

Issued: June 29, 2012

Effective: July 1, 2012

By Kenneth Mason
Vice President
Of Government and Regulatory Affairs

Applies to All Exchanges Illinois

FACILITIES FOR INTRASTATE ACCESS

4. RESERVED FOR FUTURE USE (Cont'd)

(D)

(D)

Issued: June 29, 2012

Effective: July 1, 2012

By Kenneth Mason
Vice President
Of Government and Regulatory Affairs

Applies to All Exchanges Illinois

FACILITIES FOR INTRASTATE ACCESS

4. RESERVED FOR FUTURE USE (Cont'd)

(D)

(D)

Issued: June 29, 2012

Effective: July 1, 2012

By Kenneth Mason
Vice President
Of Government and Regulatory Affairs

Applies to All Exchanges Illinois

FACILITIES FOR INTRASTATE ACCESS

4. RESERVED FOR FUTURE USE (Cont'd)

(D)

(D)

Issued: June 29, 2012

Effective: July 1, 2012

By Kenneth Mason
Vice President
Of Government and Regulatory Affairs

Applies to All Exchanges Illinois

FACILITIES FOR INTRASTATE ACCESS

4. RESERVED FOR FUTURE USE (Cont'd)

(D)

(D)

Applies to All Exchanges Illinois

FACILITIES FOR INTRASTATE ACCESS

4. RESERVED FOR FUTURE USE (Cont'd)

(D)

(D)

Applies to All Exchanges Illinois

FACILITIES FOR INTRASTATE ACCESS

4. RESERVED FOR FUTURE USE (Cont'd)

(D)

(D)

Applies to All Exchanges Illinois

FACILITIES FOR INTRASTATE ACCESS

4. RESERVED FOR FUTURE USE (Cont'd)

(D)

(D)

Applies to All Exchanges Illinois

FACILITIES FOR INTRASTATE ACCESS

4. RESERVED FOR FUTURE USE (Cont'd)

(D)

(D)

Applies to All Exchanges Illinois

FACILITIES FOR INTRASTATE ACCESS

4. RESERVED FOR FUTURE USE (Cont'd)

(D)

(D)

Applies to All Exchanges Illinois

FACILITIES FOR INTRASTATE ACCESS

4. RESERVED FOR FUTURE USE (Cont'd)

(D)

(D)

Applies to All Exchanges Illinois

FACILITIES FOR INTRASTATE ACCESS

4. RESERVED FOR FUTURE USE (Cont'd)

(D)

(D)

Applies to All Exchanges Illinois

FACILITIES FOR INTRASTATE ACCESS

4. RESERVED FOR FUTURE USE (Cont'd)

(D)

(D)

Applies to All Exchanges Illinois

FACILITIES FOR INTRASTATE ACCESS

4. RESERVED FOR FUTURE USE (Cont'd)

(D)

(D)

Applies to All Exchanges Illinois

FACILITIES FOR INTRASTATE ACCESS

SECTION 5 TABLE OF CONTENTS

<u>5. SPECIAL ACCESS</u>	<u>Page</u>
5.1 <u>General</u>	11
5.1.1 Rate Elements.....	11
(A) Special Transport.....	13
(B) Special Access Line(SAL)	14
(C) Special Access Cross Connect	17
(D) Supplemental Features	18
(E) Multiplexing Arrangements	18
(F) Special Transport Termination.....	19
5.1.2 Special Access Configurations.....	19
(A) Two-Point Service.....	19
(B) Multipoint Service.....	21
5.1.3 Special Facilities Routing.....	22
5.1.4 Design Layout Report	23
5.1.5 Acceptance Testing	23
5.1.6 Ordering Conditions.....	25
(A) Determination of Jurisdiction of Mixed Use Special Access Lines	25
(B) Special Access Jurisdictional Verification	25
5.2 <u>Description of Special Access</u>	26
5.2.1 Voiceband.....	27
(A) Two-Wire Voiceband Facility.....	27
(B) Four-Wire Voiceband Facility.....	27
5.2.2 Program Audio	28
(A) 200 to 3500 Hz	28
(B) 100 to 5000 Hz	28
(C) 50 to 8000 Hz	28
(D) 50 to 15000 Hz	28
5.2.3 Videoband	29
(A) Videoband Services - Type I.....	29
5.2.4 Wideband Analog.....	30

Applies to All Exchanges Illinois

FACILITIES FOR INTRASTATE ACCESS

SECTION 5 TABLE OF CONTENTS

5. <u>SPECIAL ACCESS</u>	<u>Page</u>
5.2 <u>Description of Special Access (Cont'd)</u>	
5.2.5 Wideband Data Service	31
5.2.6 High Capacity Digital.....	31
5.2.7 Digital Data Service	33
5.2.8 Miscellaneous Special Access Services	33
5.3 <u>Description of Terminating Options</u>	33
5.3.1 Narrowband	34
(A) 0 to 75 Baud Type 1	34
(B) 0 to 75 Baud Type 2	34
(C) 0 to 150 Baud	34
5.3.2 Voice Grade.....	34
(A) Two-Wire Voice Grade, Non-Data, Without Signaling.....	34
(B) Four-Wire Voice Grade, Non-Data, Without Signaling.....	35
(C) Voice Grade Data Termination	35
(D) Two-Wire Voice Grade Station Connecting Facility Termination	35
(E) Four-Wire Voice Grade Station Connecting Facility Termination	35
(F) Two-Wire Station Connecting Facility Termination for the Open End of an Off Premises PBX Extension	36
(G) Dial Repeating Tie Trunk Termination	36

Applies to All Exchanges Illinois

FACILITIES FOR INTRASTATE ACCESS

SECTION 5 TABLE OF CONTENTS

5. SPECIAL ACCESS (Cont'd)

	<u>Page</u>
5.3 <u>Description of Terminating Options</u> (Cont'd)	
5.3.3 Program Audio	37
(A) 200 to 3500 Hz	37
(B) 100 to 5000 Hz, 50 to 8000 Hz and 50 to 15000 Hz	37
5.3.4 Videoband	37
5.3.5 Wideband Data Service	37
5.3.6 High Capacity Digital.....	38
(A) High Capacity Digital DS1.....	38
(B) High Capacity Digital DS1C.....	38
(C) Fractional T1 Service	38
(D) FiberConnect Service	38
(E) High Capacity Digital DS3.....	39
(F) High Capacity Digital DS3C.....	39
5.3.7 Digital Data Service (DDS).....	39
5.4 <u>Description of Supplemental Features</u>	40
5.4.1 Bridging.....	40
(A) MultiPoint Data Bridging	40
(B) Voice Conference Bridging.....	40
(C) Alarm Distribution Bridging	41
(D) Program Audio Bridging	41
(E) DDS Bridging.....	41
5.4.2 Conditioning Arrangements - Data	42
(A) Type C	42
(B) Type DA	43

Applies to All Exchanges Illinois

FACILITIES FOR INTRASTATE ACCESS

SECTION 5 TABLE OF CONTENTS

5. <u>SPECIAL ACCESS</u> (Cont'd)	<u>Page</u>
5.4 <u>Description of Supplemental Features</u> (Cont'd)	
5.4.3 Conditioning – Program Audio	43
(A) Stereo Conditioning.....	43
(B) Zero Loss.....	43
5.4.4 Signaling Arrangements	44
5.4.5 Echo Control.....	46
(A) Echo Suppression	46
(B) Echo Canceller	46
5.4.6 Improved Return Loss	46
5.4.7 Voiceband Facility Switching Arrangement	47
5.4.8 Automatic Protection Switch.....	47
5.4.9 Improved Termination Option.....	47
5.4.10 Improved Equal Level Echo Path Loss Option - ELEPL-2	48
5.5 <u>Description of Multiplexing Arrangements</u>	48
(A) Group to Voice	49
(B) Supergroup to Group	49
(C) Mastergroup to Supergroup.....	49
(D) DS1 to Voice	49
(E) DS1C to Voice.....	50
(F) DS1C to DS1	50
(G) DS3 to DS1.....	50
(H) DS3C to DS1	50
(I) Group to DS1.....	50
(J) Digital Data Carrier Multiplexer	50
(K) Digital Data Subrate Multiplexer	51

Applies to All Exchanges Illinois

FACILITIES FOR INTRASTATE ACCESS

SECTION 5 TABLE OF CONTENTS

5. <u>SPECIAL ACCESS</u> (Cont'd)	<u>Page</u>
5.6 <u>Rate Regulations</u>	51
5.6.1 Types of Rates and Charges	51
(A) Monthly Rates	51
(B) Daily Rates	51
(C) Time Sensitive Rates	52
(D) Zone Density Plan – Special Access	52
(E) Nonrecurring Charges	53
(1) Design Change Charge	54
(2) Installation of Supplemental Features and Multiplexing Arrangements	55
(3) Installation of FiberConnect, FT1, DS3 and DS1 Special Access Lines.....	55
(4) Installation of Temporary Videoband Service.....	57
(5) Installation of Voicegrade, Program Audio and Digital Data Service Special Access Line.....	58
(6) Service Rearrangements.....	58

Applies to All Exchanges Illinois

FACILITIES FOR INTRASTATE ACCESS

SECTION 5 TABLE OF CONTENTS

5. <u>SPECIAL ACCESS</u> (Cont'd)	<u>Page</u>
5.6 <u>Rate Regulations</u> (Cont'd)	
5.6.2 Minimum Periods	68
5.6.3 Mileage Measurement	68
5.6.4 Moves	68
(A) Same CDL	69
(B) Different CDL	70
5.6.5 Rates and Charges on an Individual Case Basis.....	71
5.6.6 Hub Wire Centers	72
5.6.7 Shared Use Analog and Digital High Capacity Services	74
5.6.8 Temporary Videoband Service.....	75
(A) Type I	75
(1) Use of Permanent Facilities for Temporary Video Broadcast- Type 1	76
(2) Use of Nonpermanent Facilities for Temporary Video Broadcast - Type 1	77
(3) Use of Combined Facilities for Temporary Video Broadcast - Type 1	77
(4) Joint Provisioning of Service	78
5.6.9 Special Access Surcharge	79
5.6.10 Message Station Equipment Recovery Charge	81

Applies to All Exchanges Illinois

FACILITIES FOR INTRASTATE ACCESS

SECTION 5 TABLE OF CONTENTS

5. <u>SPECIAL ACCESS</u> (Cont'd)	<u>Page</u>
5.6 <u>Rate Regulations</u> (Cont'd)	
5.6.11 DS3 High Capacity Service.....	81
(A) DS3 Rate Structure.....	81
(B) Minimum Service Periods.....	83
(C) Expiration of Minimum Service Period	84
(D) Discontinuance Without Liability - DS3 Minimum Service Period	85
(E) Discontinuance With Liability - DS3 Minimum Service Period ..	85
(F) Notification of Discontinuance	87
(G) Upgrade to Higher Speed Service	87
(H) DS3 Multiplexer Cross Connect Arrangement	88
(I) Partitioned Billing Arrangement (PBA).....	88
5.6.12 Optional Payment Plan (OPP).....	90
(A) General	90
(B) Changes in Length of OPP Period.....	91
(C) Renewal Options	91
(D) Notification of Discontinuance	92
(E) Upgrade to Higher Speed Service	92
(F) Termination Liability	93
(G) Termination without Liability	93
(H) OPP for FT1 Service	94
(I) OPP for DDS	94
5.6.13 Four-Wire Voiceband and Digital Data Service (DDS)	
Rate Stability Plan (RSP)	95
(A) Description	95
(B) Eligibility Requirement	96
(C) RSP Terms and Conditions	96
(D) RSP Nonrecurring Charges	98
(E) RSP Services	99
(F) RSP Application.....	99
(1) Rate Elements Subject to the Plan	99
(2) RSP Expiration.....	100
(3) Upgrade to Higher Capacity Service	101

Applies to All Exchanges Illinois

FACILITIES FOR INTRASTATE ACCESS

SECTION 5 TABLE OF CONTENTS

5. <u>SPECIAL ACCESS</u> (Cont'd)	<u>Page</u>
5.6 <u>Rate Regulations</u> (Cont'd)	
5.6.14DS1 Term Volume Plan (TVP).....	101
(A) Description	101
(B) Rate Application.....	102
(C) Rate Changes.....	102
(D) Threshold Levels	102
(E) Changes to Commitment Quantity or Term	103
(F) TVP Plan Enrollment	103
(G) Annual Review	103
(H) TVP Conditions.....	104
(I) Penalties for Failing to Meet Commitment	105
(J) TVP Nonrecurring Charge	105
(K) Changes in Length of a TVP Period.....	105
(L) Renewal Options	106
(M) Upgrade to Higher Speed Service	106
(N) Termination Liability	106
(O) Termination without Liability	107
5.7 <u>Rates and Charges</u>	108
5.7.1 Nonrecurring Charges	108
5.7.2 Voiceband Facilities	108
(A) Standard Arrangements	108
(B) Optional Arrangements	109
5.7.3 Program Audio Facilities.....	113
(A) Standard Arrangements 200-3500 Hz	113
(B) Standard Arrangements 100-5000 Hz	113
(C) Standard Arrangements 50-8000 Hz	114
(D) Standard Arrangements 50-15000 Hz	115
(E) Optional Arrangements (50-15000 Hz Facilities Only)	115
(F) Optional Arrangements (All Bandwidths)	116

Applies to All Exchanges Illinois

FACILITIES FOR INTRASTATE ACCESS

SECTION 5 TABLE OF CONTENTS

5. <u>SPECIAL ACCESS</u> (Cont'd)	<u>Page</u>
5.7 <u>Rates and Charges</u> (Cont'd)	
5.7.4 Video Facilities.....	117
(A) Temporary Videoband Service - Type I.....	117
5.7.5 Digital Data Service Facilities.....	118
(A) Standard Arrangements	118
(B) DDS Optional Payment Plan.....	121
(C) Optional Arrangements	122
5.7.6 Multiplexing Arrangements	123
5.7.7 High Capacity Digital DS1 (1.544 Mbps) Facilities	124
(A) Standard Arrangements	124
(B) Optional Arrangements	125
(C) DS1 Optional Payment Plan	126
5.7.8 High Capacity Digital FiberConnect (6.312 Mbps) Facilities	126
(A) FiberConnect Optional Payment Plan - Electrical Interface	126
(B) FiberConnect Optional Payment Plan - Optical Interface.....	127
5.7.9 High Capacity Digital FT1 Facilities	129
(A) Standard Arrangement.....	129
(B) FT1 Optional Payment Plan	130
5.7.10 High Capacity Digital DS3 (44.736 Mbps) Facilities - Three System..	131
(A) Protected DS3.....	131
5.7.11 High Capacity Digital DS3 (44.736 Mbps) Facilities	
- Unlimited System.....	133
(A) Protected DS3.....	133
5.7.12 High Capacity Digital DS3 (44.736 Mbps) Facilities	
- Individual System	135
(A) Protected DS3 Individual	135
5.7.13 High Capacity Digital DS3 (44.736 Mbps) Facilities - Group Systems*	136
(A) Protected DS3 x 12*	136
(B) Protected DS3 x 24*	137

* Limited to those services so equipped and in service as of March 25, 1999.

Applies to All Exchanges Illinois

FACILITIES FOR INTRASTATE ACCESS

SECTION 5 TABLE OF CONTENTS

5. <u>SPECIAL ACCESS</u> (Cont'd)	<u>Page</u>
5.7 <u>Rates and Charges</u> (Cont'd)	
5.7.14 High Capacity Digital DS3 (44.736 Mbps) Facilities - Special Transport.....	138
5.7.15 High Capacity Digital DS3 (44.736 Mbps) Facilities - DS3 Multiplexer Cross Connect Arrangement	140
5.7.16 Four-Wire Voiceband and Digital Data Service (DDS) Rate Stability Plan (RSP)	140
(A) Rates	140
5.7.17 DS1 Term Volume Plan (TVP)	141
(A) Special Access Line, per DS1 SAL.....	141
5.8 <u>Miscellaneous Special Access Services</u>	151
5.8.1 Clear Channel Capability	151
(A) Description of Service	151
(B) Rates	151
5.9 <u>Special Access Cross Connect Rates and Charges</u>	151

Applies to All Exchanges Illinois

 FACILITIES FOR INTRASTATE ACCESS
5. SPECIAL ACCESS (Cont'd)5.1 General

Special Access provides a transmission path to connect CDLs* within a Market Service Area for Intrastate Telecommunications. Special Access provided to a customer may be connected directly to customer facilities, through Telephone Company Hub Wire Centers where bridging or multiplexing functions are performed, and/or may be connected to access facilities of another telephone company or companies in the joint provision of Special Access Service as well as may be connected to Switched Access as set forth in Section 4. Special Access Services may also be connected to a customer's transmission equipment and facilities using a DS1 or DS3 Cross Connect arrangement where the customer is provided Expanded Interconnection Service (EIS).

The provision of Switched Access and Special Access in combination is normally for, but not limited to, the use of WATS¹ or WATS¹-type Access. When Special Access is connected to Switched Access, the terms, conditions and rates for the facilities between the end user's CDL and the WATS¹ Serving Office are as set forth in this section of the tariff; the terms, conditions and rates for the facilities between the WATS¹ Serving Office and the IC's CDL, as well as the switching functionalities (e.g., end user access codes, screening) are as set forth in Section 4 of this tariff.

(C)

(C)

(C)

Special Access can be provided in either analog or digital format. Analog formats are differentiated by spectrum and bandwidth. Digital formats are differentiated by bit rate. The specific types of Special Access (e.g., Voiceband, Digital Data Service) provided are described in 5.2 following.

* Telephone Company CENTREX CO-like switches are considered to be CDLs for the purposes of this tariff.

¹ Wide Area Telecommunications Service (WATS) offering is grandfathered as of August 31, 2020 and limited to existing subscribers at their existing locations.

(N)

(N)

Applies to All Exchanges Illinois

FACILITIES FOR INTRASTATE ACCESS

5. SPECIAL ACCESS (Cont'd)

5.1 General

5.1.1 Rate Elements

With the exception of Temporary Videoband Service, there are six basic rate elements which apply to Special Access Service:

- Special Transport (described in 5.1.1(A) following)
- Special Transport Termination (described in 5.1.1(F) following)
- Special Access Line (described in 5.1.1(B) following)
- Special Access Cross Connect (described in 5.1.1(C) following)
- Supplemental Features (described in 5.4 following)
- Multiplexing Arrangements (described in 5.5 following)

The following is a list of Frontier’s Open Network Architecture (ONA) Special Access Basic Service Elements (BSEs) which provide a cross-reference to the generic ONA product names.

<u>Generic Name</u>	<u>Frontier Name</u>
Access to Clear Channel Transmission	Clear Channel Capability
Automatic Protection Switching	Automatic Protection Switching
Bridging	Bridging
Conditioning	Conditioning
Multiplexing - Digital 2000	Multiplexing Arrangements

*Telephone Company CENTREX CO-like switches are considered to be CDLs for the purposes of this tariff.

Applies to All Exchanges Illinois

FACILITIES FOR INTRASTATE ACCESS

5. SPECIAL ACCESS (Cont'd)5.1 General (Cont'd)5.1.1 Rate Elements (Cont'd)(A) Special Transport

- (1) The Special Transport rate element provides for the transmission facilities between the serving wire centers associated with two CDLs, between a serving wire center associated with an end user's CDL and a WATS Serving Office, between a serving wire center associated with a CDL and a Telephone Company Hub Wire Center or between two Telephone Company Hub Wire Centers. Connection to Telephone Company provided DS1 or DS3 Special Transport within a serving wire center for customers with EIS will require a Special Access Cross Connect arrangement as described in 5.1.1.

The Special Transport element is distance sensitive and varies with type of capability (i.e., analog or digital) and type of facility (e.g., Voiceband, Digital Data Service, etc.). Special Transport may be provided by more than one telephone company. The method of calculating applicable airline miles for rating purposes for Special Access is specified in 2.7 preceding.

Applies to All Exchanges Illinois

FACILITIES FOR INTRASTATE ACCESS

5. SPECIAL ACCESS (Cont'd)5.1 General (Cont'd)5.1.1 Rate Elements (Cont'd)(A) Special Transport (Cont'd)

- (2) Special Transport may be used in conjunction with Switched Access for the purpose of provisioning Originating Only, Terminating Only or Combined Originating/Terminating Access as set forth in 4.2.5(V) preceding. Special Transport employed in this manner provides the FIA for the closed-end of the services between the wire center serving the end user's CDL where WATS ¹ Serving Office functions are not available and the WATS ¹ Serving Office. (C)
(C)

When the necessary WATS ¹ Serving Office functions are not provided at the wire center which serves the end user's CDL, the Telephone Company will designate the wire center where the WATS ¹ Serving Office functions are available. (C)
(C)

(B) Special Access Line (SAL)

- (1) A Special Access Line provides the transmission facilities to a Customer Designated Location (CDL) or the facilities between a CDL and the serving wire center. This rate element varies by type of capability (i.e., analog or digital) and type of facility (e.g., Voiceband, Digital Data Service, etc.).

When a Voiceband Special Access service is ordered to be terminated at a customer's designated Interexchange Carrier's all-digital CDL which requires a minimum digital interface level of 1.544 Mbps, the Telephone Company will provide the required interface and assess the customer a Voiceband SAL, for the facility between the all-digital CDL and its serving wire center. All other appropriate charges apply in addition to the Voiceband SAL.

¹ Wide Area Telecommunications Service (WATS) offering is grandfathered as of August 31, 2020 and limited to existing subscribers at their existing locations. (N)
(N)

Applies to All Exchanges Illinois

FACILITIES FOR INTRASTATE ACCESS

5. SPECIAL ACCESS (Cont'd)5.1 General (Cont'd)5.1.1 Rate Elements (Cont'd)(B) Special Access Line (SAL) (Cont'd)

SAL rates for DS3 offerings vary with the level of capacity, number of services and whether the interface provided is electrical or optical.

Installation of DS1/DS3 SALs is as set forth in 5.6.1(E). The applicable rates are the nonrecurring charge and monthly rate set forth per DS1/DS3 SAL installed.

The selection of a Terminating Option, as defined in 5.3, is required for terminating the network portion of a Special Access Line at a CDL. Terminating Options provide a clearly delineated interface which facilitates the design, isolation, and testing of the Special Access. For DS3/DS3C Special Access, the customer may specify either an electrical or optical interface as set forth in 3.1.1.

One Special Access Line charge applies per CDL at which the facility is terminated. This charge applies even if the facilities to the CDL do not transit a serving wire center; this charge also applies if the CDL and the serving wire center are co-located in a Telephone Company building. Connection to Telephone Company provided DS1 or DS3 SALs within a serving wire center for customers with EIS will require a Special Access Cross Connect arrangement as described in 5.1.1(C). The Special Access Line charge used with a Switching Interface, as set forth in (2) below, is applicable only for the transmission facilities between the end user's CDL and the serving wire center of that location.

Applies to All Exchanges Illinois

FACILITIES FOR INTRASTATE ACCESS

5. SPECIAL ACCESS (Cont'd)5.1 General (Cont'd)5.1.1 Rate Elements (Cont'd)(B) Special Access Line (SAL) (Cont'd)

- (2) A Special Access Line may be provided in conjunction with FGA, FGB, FGC, FGD, BSA-A, BSA-B, BSA-C and BSA-D Switched Access Service for the purpose of Originating Only, Terminating Only, or Combined Originating and Terminating Access as set forth in 4.2.1 and 4.2.2. A Switching Interface is required for the provision of this service as set forth in 4.2.5(V). The Special Access Line provides the closed-end of the dedicated facilities between an end user's CDL and its serving wire center. This serving wire center may or may not be a WATS¹ Serving Office. In those instances when the serving wire center is not a WATS¹ Serving Office Special Transport is applicable as set forth in 5.1.1(B) to the nearest Telephone Company WATS¹ Serving Office.

(C)
(C)
(C)

The Switched Access used in conjunction with the Special Access Line provides various standard switching functionalities and optional arrangements as set forth in Section 4.2.5(V).

All Special Access Lines used with a Switching Interface are:

- provided with dial pulse address signaling or Dual Tone Multifrequency (DTMF) address signaling and either loop start or ground start supervisory signaling. The type of signaling is the option of the customer.
- available as either a two-wire or four-wire Voiceband Special Access Service (i.e., 300-3000 Hz bandwidth). Each transmission path is provided at the option of the customer with transmission specifications as described in Section 7000 of the Technical Interface Reference Manual.

All rules and regulations pertaining to Special Access are applicable to Special Access Lines used with a Switching Interface. Rates and Charges are found in this tariff for two-wire and four-wire Voiceband Special Access Lines.

¹ Wide Area Telecommunications Service (WATS) offering is grandfathered as of August 31, 2020 and limited to existing subscribers at their existing locations.

(N)
(N)

Applies to All Exchanges Illinois

FACILITIES FOR INTRASTATE ACCESS

5. SPECIAL ACCESS (Cont'd)5.1 General (Cont'd)5.1.1 Rate Elements (Cont'd)(B) Special Access Line (Cont'd)

(2) (Cont'd)

A customer may also order high capacity facilities from an end user's CDL to a Telephone Company Hub for the purpose of originating or terminating Special Access Lines used with a Switching Interface. High capacity to voice multiplexing will be required at the Hub. The customer will be required to submit an ASR for the high capacity facility and voice multiplexing. The customer will also be required to submit an ASR(s) for the individual Voiceband SALs specifying the channel facility assignment (CFA) for each service. This Hub may or may not be a WATS ¹ Serving Office. In those instances when the Hub is not a WATS ¹ Serving Office, Voiceband Special Transport is applicable as set forth in 5.1.1(B), for each individual Special Access Line used with a Switching Interface to the Telephone Company designated WATS ¹ Serving Office.

(C)

(C)

(C)

(C) Special Access Cross Connect

The Special Access Cross Connect charge provides the communications path between Telephone Company provided 64 Kbps DDS (DSO), DS1 or DS3 Special Access Lines or Special Access Transport and a customer's transmission equipment and facilities where the customer is provided EIS. The Special Access Cross Connect charge may also provide the communications path between a customer's transmission equipment and facilities where the customer is provided EIS and EIS arrangements of another customer. The Cross Connect arrangement may connect directly to 64 Kbps DDS (DSO), DS1 or DS3 Services or to a 64 Kbps DDS (DSO), DS1 or DS3 multiplexing arrangement. The Cross Connect charge applies per 64 Kbps DDS (DSO), DS1 or DS3 connection. Rates for 64 Kbps DDS (DSO), DS1 and DS3 Cross Connect arrangements in 5.9 will apply in addition to other charges.

¹ Wide Area Telecommunications Service (WATS) offering is grandfathered as of August 31, 2020 and limited to existing subscribers at their existing locations.

(N)

(N)

Applies to All Exchanges Illinois

FACILITIES FOR INTRASTATE ACCESS

5. SPECIAL ACCESS (Cont'd)5.1 General (Cont'd)5.1.1 Rate Elements (Cont'd)(D) Supplemental Features

Supplemental Features may be added to a Special Access circuit to improve its quality or utility to meet specific communications requirements. These are not necessarily identifiable with specific facilities, but rather represent the end result in terms of performance characteristics which may be obtained. These characteristics may be obtained by using various combinations of facilities. Although the facilities necessary to perform a specified function may be installed at various locations along the path of the Special Access circuit, including the CDL, it will be provided for as a single rate element.

Examples of Supplemental Features that are available include, but are not limited to, bridging and conditioning. Each Supplemental Feature is described in 5.4, and rates are set forth in 5.7.

(E) Multiplexing Arrangements

Multiplexing provides for arrangements to convert a single higher capacity or bandwidth circuit for bulk transport to several lower capacity or bandwidth circuits. Multiplexing is only available at a Telephone Company designated Hub Wire Center arranged for multiplexing. All types of multiplexing may not be available at each Hub Wire Center. Refer to Section 5.6.6 for a description of Hub Wire Center. Descriptions for each type of multiplexing arrangements are provided in 5.5 following, and rates are set forth in 5.7 following.

Applies to All Exchanges Illinois

FACILITIES FOR INTRASTATE ACCESS

5. SPECIAL ACCESS (Cont'd)5.1 General (Cont'd)5.1.1 Rate Elements (Cont'd)(F) Special Transport Termination(1) DS1 and DS3 Service

The Special Transport Termination rate element as set forth in 5.7, applies only to DS1, Individual DS3 and System DS3 offerings and is in addition to the Special Transport rate element. Special Transport Termination provides the equipment and arrangements necessary to terminate the Special Transport facility at a serving wire center. One Special Transport Termination charge applies for the termination of each end of a Special Transport facility for DS1 and DS3 (Individual and Systems) offerings.

(2) Fractional T1 Service (FT1)

For Fractional T1 Service, Special Transport Termination must be ordered as Fractional Special Transport Termination in the same grouping (N x 56 Kbps or N x 64 Kbps where N = 2, 4, or 6) as the associated FT1 SALs.

5.1.2 Special Access Configurations

There are two types of facility configurations over which Special Access Services are provided - two-point and multipoint.

(A) Two-point Service

A two-point configuration is a circuit which is provided to connect two CDLs, either directly connected or through a Hub Wire Center where multiplexing functions are performed, or a CDL and a WATS Serving Office.

All Special Access offerings may be provided as a two-point configuration.

Applies to All Exchanges Illinois

FACILITIES FOR INTRASTATE ACCESS

5. SPECIAL ACCESS (Cont'd)

5.1 General (Cont'd)

5.1.2 Special Access Configurations (Cont'd)

(A) Two-point Service (Cont'd)

With the exception of Temporary Videoband Service, applicable rate elements are:

- Special Access Lines
- Special Transport (when applicable)
- Special Transport Termination (when applicable)
- Supplemental Features (when applicable)
- Multiplexing Arrangements (when applicable)

The following diagram depicts a typical two-point service connecting two CDLs. The service is provided with the supplemental feature of Type C Conditioning:

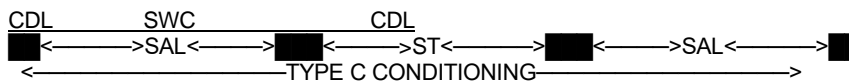

SAL - Special Access Line
 ST - Special Transport
 SWC - Serving Wire Center
 CDL - Customer Designated Location

Applicable rate elements are:

- Special Access Line (2 applicable)
- Special Transport (per airline mile between SWCs)
- Supplemental Feature of Type C Conditioning (2 applicable)

In addition, a Special Access Surcharge, as set forth in 5.6.9 following, and a Message Station Equipment Recovery Charge, as set forth in 5.6.10 following may be applicable.

Applies to All Exchanges Illinois

FACILITIES FOR INTRASTATE ACCESS

5. SPECIAL ACCESS (Cont'd)

5.1 General (Cont'd)

5.1.2 Special Access Configurations (Cont'd)

(B) Multipoint Service

A multipoint configuration is a circuit that is provided to connect three or more CDLs through a Telephone Company Hub Wire Center.

Only Voiceband, Program Audio, Digital Data Service facilities, and Miscellaneous Services where so designated, will be provided as multipoint configurations. There is no limitation on the number of mid-links, but the use of more than three mid-links in tandem may degrade the quality of the multipoint facilities. A mid-link is defined as the Special Transport facilities between Hub Wire Centers where the circuit is bridged and/or where circuit switching devices, such as loop transfer arrangement, are located.

Multipoint Service is provided in the following manner:

- (1) Special Access Line per CDL to their respective serving wire centers.
- (2) Special Transport between serving wire centers associated with the CDLs and the Hub Wire Center.
- (3) Special Transport between Hub Wire Centers.
- (4) Supplemental Features: Bridging equipment for each bridging location and other Supplemental Features when applicable.
- (5) Multiplexing Arrangements when applicable.

Applies to All Exchanges Illinois

FACILITIES FOR INTRASTATE ACCESS

5. SPECIAL ACCESS (Cont'd)

5.1 General (Cont'd)

5.1.2 Special Access Configurations (Cont'd)

(B) Multi-point Service (Cont'd)

The following diagram depicts a multipoint service connecting four CDLs via two customer specified Hub Wire Centers:

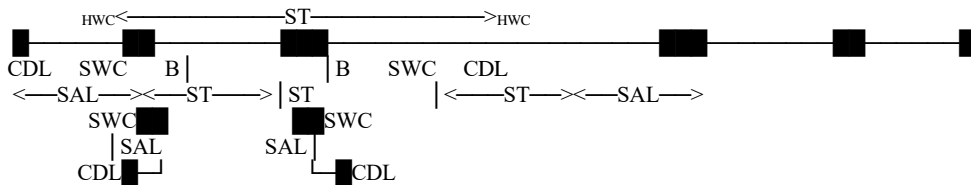

- SAL - Special Access Line
- ST - Special Transport
- SWC - Serving Wire Center
- CDL - Customer Designated Location
- HWC - Hub Wire Center
- B - Bridging

Applicable rate elements are:

- Special Access Lines (4 applicable)
- Special Transport (5 segments, per airline between SWCs and HWCs)
- Bridging (6 applicable, one per bridge port)

In addition, the Special Access Surcharge, as set forth in 5.6.9 following, and the Message Station Equipment Recovery Charge, as set forth in 5.6.10 may be applicable.

5.1.3 Special Facilities Routing

A customer may request that the facilities used to provide Special Access Service be specially routed. The regulations, rates and charges for Special Facilities Routing (i.e., Avoidance, Diversity and Cable-Only) are as set forth in Section 9 following.

Applies to All Exchanges Illinois

FACILITIES FOR INTRASTATE ACCESS

5. SPECIAL ACCESS (Cont'd)5.1 General (Cont'd)5.1.4 Design Layout Report

The Telephone Company will provide to the customer the makeup of the Special Access provided under this tariff to aid the customer in designing its overall service. This information will be provided in the form of a Design Layout Report and will include the following:

Cable gauge, length and loading.
Makeup (e.g., T-Carrier, two-wire, four-wire, etc.)
Specific pair of circuit assignment at the customer designated location.

The Design Layout Report will be provided to the customer within fourteen working days from the ASR Date. Updated reports will be reissued within fourteen working days whenever facilities provided to the customer are materially changed. Both the initial and updated Design Layout Reports will be provided to the customer at no charge.

5.1.5 Acceptance Testing

At the time of installation, the following test parameters apply:

- (A) For Voiceband services, acceptance testing will include tests for loss, 3-tone slope, DC continuity, operational signaling, C-notched noise, and C-message noise.

When the Interface Arrangement provides a four-wire voice transmission facility and the point of termination provides two-wire voice transmission (i.e., there is a four-wire to two-wire conversion at the point of termination) balance tests are also included in acceptance testing. When performing installation and acceptance testing, the Telephone Company will test the access service within the MSA.

Applies to All Exchanges Illinois

FACILITIES FOR INTRASTATE ACCESS

5. SPECIAL ACCESS (Cont'd)5.1 General (Cont'd)5.1.5 Acceptance Testing (Cont'd)

(A) (Cont'd)

On four-wire and effective four-wire circuits where the Network Channel Terminating Equipment (NCTE) has the capability of being remotely aligned, the Telephone Company may perform acceptance testing without a Telephone Company technician at the customer's premises. Should the customer request a technician be present at the customer's premises, additional charges will apply as set forth in Section 6.2. The applicable rates are in Section 6.2(G).

If the NCTE at the customer's premises does not have the capability of being aligned remotely, the additional charges will not apply. The Telephone Company will determine the type of NCTE placed at a customer's premises.

- (B) For other analog services (i.e., Program Audio, Video, Wideband Analog and Wideband Data Services) and for digital services (i.e., Digital Data Services and High Capacity Digital Services), acceptance testing will include tests for the parameters applicable to the service as set forth in Section 7000 of the Technical Interface Reference Manual for each of these services.

When the customer requests the performance of additional cooperative tests which are not required to meet these specified performance parameters, charges as set forth in 6.6(C) following will apply. All test results will be made available to the customer upon request.

If acceptance tests are not started within 15 minutes after pre-service tests have been completed and the customer has been notified by the Telephone Company, additional charges may apply, as set forth in 6.2 following, unless the delay is caused by the Telephone Company.

Applies to All Exchanges Illinois

FACILITIES FOR INTRASTATE ACCESS

5. SPECIAL ACCESS (Cont'd)

5.1 General (Cont'd)

5.1.6 Ordering Conditions

Ordering conditions are set forth in detail in Section 3. preceding. Also included in that section, are other charges which may be associated with ordering Special Access (e.g., Service Date Change Charges, Cancellation Charges, etc.).

(A) Determination of Jurisdiction of Mixed Use Special Access Lines

When mixed interstate and intrastate Special Access Service is ordered, the jurisdiction will be determined as follows:

1. If the customer's estimate of the interstate traffic on the physically intrastate line involved constitutes 10% or less of the total traffic on that line, the line will be ordered and provided in accordance with the applicable rules and regulations of this tariff.
2. If the customer's estimate of the interstate traffic on the physically intrastate line involved constitutes more than 10% of the total traffic on that line, the line will be ordered and provided in accordance with the applicable rules and regulations of the appropriate interstate tariff.

(B) Special Access Jurisdictional Verification

If a billing dispute arises or a regulatory commission questions the customer's certification of the jurisdiction of the line the Telephone Company will ask the customer to provide the data used to determine the jurisdiction. The customer shall supply the data within 30 days of the Telephone Company's request. The customer shall keep records of system design and functions from which the jurisdiction can be ascertained and upon request of the Telephone Company make the records available for inspection as reasonably necessary for purposes of verification of the jurisdiction of the service.

Applies to All Exchanges Illinois

FACILITIES FOR INTRASTATE ACCESS

5. SPECIAL ACCESS (Cont'd)5.2 Description of Special Access

There are seven generic types of Special Access offerings. They are:

- Voiceband
- Program Audio
- Videoband
- Wideband Analog
- Wideband Data *
- High Capacity Digital
- Digital Data Service

Each type has its own characteristics, and are subdivided by one or more of the following:

- Transmission specifications
- Bandwidth
- Speed (i.e., bit rate)
- Spectrum

The Special Access offerings described below are comprised of a combination of the rate elements. The following descriptions indicate the most effective use for each facility. Customer use for purposes other than those indicated is limited only to the extent that such use must not harm the network. Further, the Telephone Company does not guarantee transmission performance beyond the parameters identified in the descriptions.

The transmission performance characteristics of each Special Access offering are stated in Section 7000 of the Technical Interface Reference Manual. The Telephone Company will maintain existing transmission specifications on services installed prior to the effective date of this tariff, except that existing services with performance specifications exceeding the standards in the Technical Interface Reference Manual will be maintained at the performance level specified in the manual. Where transmission performance characteristics are required other than those as stated in Section 7000 of the Technical Interface Reference Manual, the Telephone Company will review, and where technically feasible, will develop rates and charges for the additional costs associated with provisioning the parameters. These rates and charges will be filed on an individual case basis and will apply in addition to all other applicable rates and charges.

* Limited to those offerings in service as of May 30, 1992.

Applies to All Exchanges Illinois

FACILITIES FOR INTRASTATE ACCESS

5. SPECIAL ACCESS (Cont'd)

5.2 Description of Special Access (Cont'd)

The customer also has the option of ordering Voiceband and analog and digital high capacity facilities to a Telephone Company Hub for multiplexing to individual channels of a lower capacity or bandwidth. Descriptions of the types of multiplexing available at the Hubs, as well as the number of individual channels which may be derived from each type of facility, are set forth in 5.5. Additionally, the customer may specify supplemental features for the individual channels derived from the facility to further tailor the channel to meet specific communications requirements. Descriptions of the supplemental features available are set forth in 5.4.

For example, a customer may order a DS3 from a CDL to a Telephone Company Hub for multiplexing to 28 DS1 channels. The DS1 channels may be further multiplexed at the same or a different Hub to Voiceband channels or may be extended to other CDLs. Optional features may be added to either the DS1 or the Voiceband channels.

5.2.1 Voiceband

(A) Two-Wire Voiceband Facility

These facilities are unconditioned and are capable of transmitting voice or data signals within the frequency spectrum of approximately 300 Hz to 3000 Hz. These facilities are furnished on a two-point or multipoint basis and may be terminated two-wire or four-wire at the point of termination. They permit the simultaneous transmission of information in both directions over a circuit, but it is not possible to ensure independent information transmission in both directions. Supplemental features may be added, at applicable charges, to enhance the operational capabilities of these facilities.

(B) Four-Wire Voiceband Facility

These facilities are unconditioned and are capable of transmitting voice or data signals within the frequency spectrum of approximately 300 Hz to 3000 Hz. The facilities are furnished on a two-point or multipoint basis and may be terminated two-wire or four-wire at the point of termination. When terminated four-wire, they permit simultaneous independent transmission of information in both directions over a circuit. However, when terminated two-wire, simultaneous independent transmission cannot be supported. Supplemental features may be added, at applicable charges, to enhance the operational capabilities of these facilities.

Applies to All Exchanges Illinois

FACILITIES FOR INTRASTATE ACCESS

5. SPECIAL ACCESS (Cont'd)5.2 Description of Special Access (Cont'd)5.2.2 Program Audio

These facilities are arranged and provided for the transmission of non broadcast audio or which is to be used in connection with loudspeakers, wired music, closed circuit or recordings. Audio facilities are furnished for transmission in one direction. Facilities for broadcast Program Audio are available from the Telephone Company's Facilities for Interstate Access Tariff, Frontier FCC No. 4. Audio facilities may be provided on a two-point or multipoint basis.

Program audio facilities are provided on either a full-time or part-time basis. The minimum periods for full-time and part-time service are set forth in 3.2.4. When a part-time program audio service is provided for ten or more consecutive days it will be treated as a full-time service and rated accordingly. In no event will the charge for continuous part-time program audio exceed the amount that would have been charged in the same time period for full-time program audio facilities.

Listed below are the types of Program Audio facilities that are offered under this tariff.

(A) 200 to 3500 Hz

Facilities are generally acceptable for speech quality programming and are subject to use over limited distance due to transmission factors.

(B) 100 to 5000 Hz

Facilities are generally acceptable for music and provide good quality speech programming.

(C) 50 to 8000 Hz

Facilities for the provision of high fidelity music transmission.

(D) 50 to 15000 Hz

Facilities for the provision of high fidelity music transmission. Two such facilities may be conditioned, at applicable charges, for stereo operation.

Applies to All Exchanges Illinois

FACILITIES FOR INTRASTATE ACCESS5. SPECIAL ACCESS (Cont'd)5.2 Description of Special Access (Cont'd)5.2.3 Videoband

These facilities are arranged and provided for the transmission of closed circuit television or used in connection with viewing or recording. Facilities for broadcast television are available from the Telephone Company's Facilities for Interstate Access Tariff, Frontier FCC No. 4.

The facilities are furnished for two point transmission in one direction only of United States 525 line/60 field standard monochrome and National Television Systems Committee (NTSC) color television baseband video signals and the associated audio signals.

(A) Videoband Services - Type I

Videoband Services - Type I are provided on a full-time or part-time (temporary) basis. The minimum periods are set forth in 3.2.4 and 3.2.5 preceding. The monthly rates and nonrecurring charges for full-time Videoband Service - Type I will be developed on an Individual Case Basis. The hourly rates and nonrecurring charges for temporary service are those set forth in Section 5.7.4(A).

There is a maximum monthly charge that may be assessed to any temporary Videoband Service -Type I as described in 5.6.1(C).

Technician Standby is a nonoptional arrangement furnished only in conjunction with temporary Videoband Service - Type I. Technician Standby provides for Telephone Company monitoring of the temporary video broadcast to ensure satisfactory transmission. The Telephone Company will determine the location of the video technician. At the option of the customer, additional technicians will be made available during the temporary Videoband - Type I broadcast; the customer will be assessed the Technician Standby charge, as set forth in Section 5.7.4(A), for each additional technician.

Applies to All Exchanges Illinois

FACILITIES FOR INTRASTATE ACCESS

5. SPECIAL ACCESS (Cont'd)

5.2 Description of Special Access (Cont'd)

5.2.3 Videoband (Cont'd)

(A) Videoband Services - Type I (Cont'd)

A customer may request (as an option) an active, alternate temporary Type I Videoband transmission path for use in the event that the primary service becomes inoperative. This is referred to as a "hot standby" facility. The charge for this additional service will be the nonrecurring charges and hourly rates set forth in Section 5.7.4(A) for Temporary Videoband - Type I Facilities. Technician Standby charges are not applicable to the "hot standby" facility.

5.2.4 Wideband Analog

These facilities are two point and are furnished between CDLs or between a CDL and a Telephone Company designated Hub Wire Center where multiplexing is offered. The three types of Wideband Analog facilities are:

- (A) Group band facilities with a bandwidth from 60 Khz to 108 Khz for the transmission of a 12 circuit frequency division multiplexer (FDM) group.
- (B) Supergroup band facilities with a bandwidth from 312 Khz to 552 Khz for the transmission of a 60 circuit FDM supergroup.
- (C) Mastergroup band facilities with a bandwidth from 564 Khz to 3084 Khz for the transmission of a 600 circuit FDM mastergroup.

Applies to All Exchanges Illinois

FACILITIES FOR INTRASTATE ACCESS

5. SPECIAL ACCESS (Cont'd)

5.2 Description of Special Access (Cont'd)

5.2.5 Wideband Data Service *

These analog facilities are arranged and furnished for two-point simultaneous two-way transmission of high speed data between two CDLs. These facilities are normally utilized for the following data speeds: 19.2 Kbps, 50 Kbps, 56 Kbps and 230.4 Kbps.

5.2.6 High Capacity Digital

These facilities are two point and are furnished between CDLs or between a CDL and a Telephone Company designated Hub Wire Center where multiplexing is offered. High Capacity facilities may be used to provide Special Access Lines as set forth in 5.1.1(B)(2). A High Capacity to Voice multiplexing arrangement, as described in Section 5.5, is required at the Hub Wire Center. High Capacity DS1 and DS3 services may also be connected to customer transmission equipment and facilities where the customer is provided EIS.

- (A) DS1 facilities provide for the transmission of isochronous bipolar serial data at a rate of 1.544 Mbps.
- (B) DS1C facilities provide for the transmission of isochronous bipolar serial data at a rate of 3.152 Mbps.
- (C) FT1 facilities are furnished for the transmission of isochronous bipolar serial data and are available at transmission rate groupings of N x 56 Kbps or N x 64 Kbps where N equals 2, 4, or 6. FT1 channels are contiguous within the network and can be used to create a wideband circuit using customer provided equipment. When N x 64 FT1 is ordered in conjunction with DS1 service for multiplexing purposes, the DS1 must have Clear Channel Capability as described in 5.7.6. FT1 Service at a rate of N x 64 Kbps will only be provided where Clear Channel capability is available in the network. Where Clear Channel Capability is not available, N x 56 Kbps service can be provided in lieu of N x 64 Kbps.

* Limited to those services so equipped and in service as of May 30, 1992.

Applies to All Exchanges Illinois

FACILITIES FOR INTRASTATE ACCESS

5. SPECIAL ACCESS (Cont'd)5.2 Description of Special Access (Cont'd)5.2.6 High Capacity Digital (Cont'd)

(D) FiberConnect service facilities which are only available as an OPP, provide for the transmission of an isochronous serial data stream at a rate of 6.312 Mbps, encoded and converted to a signal suitable for optical transport. FiberConnect service is transmitted on fiber optic cable. When FiberConnect is provided with a fiber optic interface at the CDL, a single transmission channel is provided with a data rate dependent on the Telephone Company fiber optic terminal equipment used to provision the facility. When FiberConnect is provided with an electrical interface, four transmission channels of 1.544 Mbps each are provided at the interface.

Fiber Optic Interface denotes the termination of service with single mode fiber optic cable at the customer premises. When this interface is selected, it is the customer's responsibility to provide the optical line termination at his premises. This equipment must be compatible with the Telephone Company provided equipment.

FiberConnect is offered only on a protected basis between a CDL and its serving wire center. FiberConnect is not available with multipoint services. Special Transport between serving wire centers for FiberConnect is ordered as 1, 2, 3 or 4 DS1s.

(E) DS3 facilities provide for the transmission of isochronous bipolar serial data at a rate of 44.736 Mbps. The Telephone Company will provide either an interface with Telephone Company electronics (electrical) or without Telephone Company electronics (optical) at the option of the customer. Ordering conditions are set forth in 3.1.1(F). EIS is not available with DS3 services provided with an optical interface.

(F) DS3C facilities provide for the transmission of isochronous bipolar serial data at a rate of 89.472 Mbps. The Telephone Company will provide an optical interface with this service unless the service is provided via microwave, in which case an electro-magnetic interface is provided, or unless the customer requests an electrical interface. Ordering conditions are set forth in 3.1.1(F).

Applies to All Exchanges Illinois

FACILITIES FOR INTRASTATE ACCESS

5. SPECIAL ACCESS (Cont'd)5.2 Description of Special Access (Cont'd)5.2.7 Digital Data Service

Facilities for Digital Data Service are furnished for the simultaneous two-way transmission of synchronous data and are available at transmission speeds of: 2.4 Kbps, 4.8 Kbps, 9.6 Kbps, 19.2 Kbps, 56 kbps or 64 Kbps. Digital Data facilities may be provided on a two-point or multipoint basis.

5.2.8 Miscellaneous Special Access Services

A description of each service provided under Miscellaneous Special Access Services, along with the rates is set forth in 5.8 following. Other Special Access rate elements may apply in addition to those found in 5.8.

5.3 Description of Terminating Options

Terminating Options provide a clearly delineated interface between Telephone Company and customer facilities at the point of termination at the CDL. Terminating Options facilitate the design, isolation, and testing of the Special Access. The description of each Terminating Option defines the most effective use of the Terminating Option. The technical parameters of each type of associated interface are set forth in Section 7000 of the Technical Interface Reference Manual. Although a customer is not restricted from alternate applications, except where such application is harmful to the network, the Telephone Company cannot guarantee technical performance for other than the applications stated below. Terminating Options are nonchargeable.

Applies to All Exchanges Illinois

FACILITIES FOR INTRASTATE ACCESS

5. SPECIAL ACCESS (Cont'd)

5.3 Description of Terminating Options (Cont'd)

5.3.1 Narrowband

(A) 0 to 75 Baud Type 1

Provides standard open/closed 20 or 62 Ma energized interface to customer terminal equipment and converts customer terminal equipment signals to voice frequency signaling for transmission over two-wire or four-wire voiceband network facilities suitable for voice grade to narrowband multiplexing. This terminating option is obsolete and is limited to those circuits so equipped and in service as of May 30, 1992.

(B) 0 to 75 Baud Type 2

Provides two-wire or four-wire metallic interface for customer or Telephone Company energized circuits. Telephone Company energized circuits are only available in conjunction with voice grade to narrowband multiplexing. This option does not guarantee dc current operation over special transport facilities. This terminating option is obsolete and is limited to those circuits so equipped and in service as of May 30, 1992.

(C) 0 to 150 Baud

Provides standard RS-232C interface to customer terminal equipment and converts customer terminal equipment signals to voice frequency signaling for transmission over two-wire or four-wire voiceband facilities. This terminating option is obsolete and is limited to those circuits so equipped and in service as of May 30, 1992.

5.3.2 Voice Grade

(A) Two-Wire Voice Grade, Non-Data, Without Signaling

This option provides a two-wire interface to a customer and terminates an effective two-wire facility furnished for voice transmission only. Customer provided signaling must be limited to tones in the voiceband. Customer provided voiceband signaling must limit transmission power to 0.0 dBm peak and -13 dBm average power over a three-second period.

Applies to All Exchanges Illinois

FACILITIES FOR INTRASTATE ACCESS

5. SPECIAL ACCESS (Cont'd)5.3 Description of Terminating Options (Cont'd)5.3.2 Voice Grade (Cont'd)(B) Four-Wire Voice Grade, Non-Data, Without Signaling

This option provides a four-wire interface to the customer terminal equipment and terminates an effective four-wire facility furnished for voice transmission only. Customer provided signaling must be limited to tones in the voiceband. Customer provided voiceband signaling equipment must limit transmission power to 0.0 Dbm peak and -13 Dbm average power over a three-second period.

(C) Voice Grade Data Termination

This option provides a two-wire or four-wire transmission interface to a customer's private line data modem and terminates an effective four-wire facility furnished for voiceband data transmission.

(D) Two-Wire Voice Grade Station Connecting Facility Termination

This option provides a means to terminate an effective two-wire facility or an effective four-wire facility with a two-wire customer interface on a telephone, key system, PBX, ACD, or similar equipment. This option is normally used to terminate facilities that furnish foreign central office service, the station end of PBX off premises service, or private switched service network access lines. The option provides both the transmission and loop signaling functions normally associated with these services. The option is also used to terminate facilities arranged with automatic ringdown signaling. This option provides the loop and ringdown signaling with the facility.

(E) Four-Wire Voice Grade Station Connecting Facility Termination

A terminating option similar to (D) preceding used to terminate effective four-wire foreign central office service. The option provides a four-wire transmission interface to the customer terminal equipment and the loop signaling function normally associated with these services. This option provides the loop and ringdown signaling with the facility.

Applies to All Exchanges Illinois

FACILITIES FOR INTRASTATE ACCESS

5. SPECIAL ACCESS (Cont'd)5.3 Description of Terminating Options (Cont'd)5.3.2 Voice Grade (Cont'd)(F) Two-Wire Station Connecting Facility Termination for the Open End of an Off Premises PBX Extension

Terminating options are available depending on the signaling range of the PBX (or similar system) as defined in Part 68 of the FCC Rules and Regulations. Type 1 is an option requiring range extension equipment at the CDL. Type 2 is an option with no range extension equipment at the CDL. If needed, the loop signaling range equipment for Type 1 must be specifically specified, see Section 5.4.4 following for available arrangements.

(G) Dial Repeating Tie Trunk Termination

Two network terminating options are provided for terminating effective four-wire transmission facilities used to furnish dial repeating tie trunk services. These options are described in terms of the interface they provide to a PBX (or similar system).

- (1) A Type I tie line termination provides the customer with a two-wire transmission interface and includes either two-wire or four-wire E&M type signaling. Transmission and signaling interface options available are described in Part 68 of the FCC Rules and Regulations. This option provides the E&M type signaling with the facility.
- (2) A Type III tie line termination provides the customer with a four-wire transmission interface and includes either two-wire or four-wire E&M type signaling. Transmission and signaling options available are described in Part 68 of the FCC Rules and Regulations. This option provides the E&M signaling with the facility.

Applies to All Exchanges Illinois

FACILITIES FOR INTRASTATE ACCESS

5. SPECIAL ACCESS (Cont'd)

5.3 Description of Terminating Options (Cont'd)

5.3.3 Program Audio

(A) 200 to 3500 Hz

Provides standard program audio interface levels and impedance matching to two-wire network facilities.

(B) 100 to 5000 Hz, 50 to 8000 Hz, and 50 to 15000 Hz

Provides standard program audio interface levels, circuit equalization and impedance matching to two-wire network facilities.

5.3.4 Videoband

Provides a Videoband Special Access Line interface for use in providing the one way transmission of video signals.

Standard Videoband service is provided via one signal (combined video and audio). It includes a one-way or two-way transmission of standard 525 lines/60 fields monochrome or NTSC color video signal, and one or two associated 15 KHz audio signals.

5.3.5 Wideband Data Service *

(A) Provides a Wideband Data Service Special Access interface for use in providing two-way transmission of sequential synchronous or nonsynchronous data at rates of 19.2, 50 or 230.4 Kbps; or sequential synchronous bipolar data signals at a rate of 56 Kbps over four-wire facilities.

* Limited to those services so equipped and in service as of May 30, 1992.

Applies to All Exchanges Illinois

FACILITIES FOR INTRASTATE ACCESS

5. SPECIAL ACCESS (Cont'd)5.3 Description of Terminating Options (Cont'd)5.3.6 High Capacity Digital(A) High Capacity Digital DS1

Provides a High Capacity Digital DS1 Special Access interface for use in providing simultaneous two-way transmission of isochronous bipolar serial data signals at the rate of 1.544 Mbps.

(B) High Capacity Digital DS1C

Provides a High Capacity Digital DS1C Special Access interface for use in providing simultaneous two-way transmission of isochronous bipolar serial data signals at the rate of 3.152 Mbps.

(C) Fractional T1 Service

Provides a DS1 Special Access interface for use in providing simultaneous two-way transmission of isochronous bipolar serial data signals and is limited to groupings of $N \times 56$ Kbps or $N \times 64$ Kbps where N equals 2, 4, or 6.

(D) FiberConnect Service

Provides a High Capacity Digital Special Access interface for use in providing simultaneous two-way transmission of isochronous bipolar serial data. The Telephone Company, at the option of the customer, will provide either an electrical or a fiber optic interface. The electrical interface option provides four electrical channels at 1.544 Mbps each. The fiber optic interface option is provided on a single mode fiber and terminates on fiber optic connectors. The 6.312 Mbps signal will be made up of four transmission channels of 1.544 Mbps each and will be encoded to an optical data rate dependent on the fiber optic terminal equipment used by the Telephone Company to provision the facility. When the optical interface is selected, it is the customer's responsibility to provide the optical line termination at his premises. This equipment must be compatible with the equipment provided by the Telephone Company. Service will be provided on a one for one protected basis only.

Applies to All Exchanges Illinois

FACILITIES FOR INTRASTATE ACCESS

5. SPECIAL ACCESS (Cont'd)5.3 Description of Terminating Options (Cont'd)5.3.6 High Capacity Digital (Cont'd)(E) High Capacity Digital DS3

Provides a High Capacity Digital DS3 Special Access interface for use in providing simultaneous two-way transmission of isochronous bipolar serial data signals at the rate of 44.736 Mbps. The Telephone Company will provide either an interface with Telephone Company electronics (electrical) or without Telephone Company electronics (optical) as specified by the customer. EIS is not available with DS3 services provided with an optical interface. Ordering conditions are set forth in 3.1.1.

(F) High Capacity Digital DS3C

Provides a High Capacity Digital DS3C Special Access interface for use in providing simultaneous two-way transmission of isochronous bipolar serial data signals at the rate of 89.472 Mbps. The Telephone Company will provide an optical interface with this service unless the service is provided via microwave, in which case, an electromagnetic interface is provided, or unless the customer requests an electrical interface. Ordering conditions are set forth in 3.1.1.

5.3.7 Digital Data Service (DDS)

Provides DDS Special Access interface for use in providing simultaneous two-way transmission of sequential bipolar data signals at transmission speeds of 2.4 Kbps, 4.8 Kbps, 9.6 Kbps, 19.2 Kbps, 56 Kbps or 64 Kbps over four-wire facilities.

Applies to All Exchanges Illinois

FACILITIES FOR INTRASTATE ACCESS

5. SPECIAL ACCESS (Cont'd)5.4 Description of Supplemental Features

Supplemental Features are items which can be added to a Special Access service to provide enhanced capabilities or improve its utility. References to specific uses or Special Access types indicate the most effective use for each Supplemental Feature. Customer use for other purposes or with other Special Access types is limited only to the extent that such use must not harm the network. Further, the Telephone Company does not guarantee functional operation of Supplemental Features for these alternate applications.

Listed below are the Supplemental Features that are offered under this tariff.

5.4.1 Bridging

Bridging is the function of connecting three or more CDLs in a multipoint arrangement. Listed below are those bridging services offered under this tariff.

(A) Multi-Point Data Bridging

This feature provides the capability to derive a multipoint data circuit from a single facility and is normally provided on Voiceband facilities provided for transmission of data signals. This function is provided on a per port basis. Polled multipoint data circuits are a typical application of this feature.

(B) Voice Conference Bridging

Bridging arrangement to connect multiple Voiceband facilities in order that a voice frequency input signal from any location will be reproduced at the output of all other circuit locations. This function is provided on a per port basis.

Applies to All Exchanges Illinois

FACILITIES FOR INTRASTATE ACCESS

5. SPECIAL ACCESS (Cont'd)5.4 Description of Supplemental Features (Cont'd)5.4.1 Bridging (Cont'd)(C) Alarm Distribution Bridging

Provides polling type bridging capabilities, band splitting filters and conversion of four-wire common terminations up to a capacity of 40 two-wire terminations. This function is offered as two tariff elements. The first element provides all shelving and common equipment for a capacity of 40 two-wire terminations. The second element provides a two-wire port. One common equipment rate element will apply to accommodate up to 40 two-wire terminations. One two-wire port charge will apply to each two-wire Special Access Line terminated in the bridge.

(D) Program Audio Bridging

An arrangement to provide multiple channel outputs from a single Program Audio or Voiceband facility. This arrangement is provided and rated on a per port basis.

(E) DDS Bridging

Provides for a multi-junction unit (MJU) arrangement to bridge 2.4 kbps, 4.8 kbps, 9.6 kbps, 56 kbps or 64 kbps DDS facilities. Different speeds cannot be mixed on the same bridge. This function is provided on a per port basis.

Applies to All Exchanges Illinois

FACILITIES FOR INTRASTATE ACCESS

5. SPECIAL ACCESS (Cont'd)5.4 Description of Supplemental Features (Cont'd)5.4.2 Conditioning Arrangements - Data

Data conditioning, when utilized in conjunction with effective four-wire Voiceband transmission facilities, improves the characteristics of these facilities. These improved characteristics are not represented to apply to the entire end to end facility of the customer, but only to that portion of the facility provided by the Telephone Company.

There are three types of data conditioning: Type C, Type C-Improved and Type DA. Type C and Type C-Improved conditioning control attenuation distortion and envelope delay distortion. Type DA controls the signal to C-notched noise ratio and intermodulation distortion. Type C and Type DA conditioning may be combined on the same circuit. Type C-Improved and Type DA conditioning may be combined on the same circuit.

Data conditioning is charged for on a per Special Access line basis. The parameters listed for each type of data conditioning apply from two or more CDLs located within the Telephone Company serving area. Conditioning parameters apply to each end of a two-point circuit. For multipoint circuits, the conditioning parameters apply from any CDL to either the point of interface at another CDL or the first Telephone Company bridging point depending on the circuit configuration. These parameters are not applicable to High Capacity or Wideband Analog points of interface, because there is no voice frequency test access point. In these instances the data conditioning parameters apply to the last telephone company voice frequency test access point before the High Capacity or Wideband Analog point of interface.

(A) Type C

Type C conditioning of Voiceband facilities provides a facility with the following transmission parameters enhanced to meet the values specified for Type C conditioning in Section 7000 of the Technical Interface Reference Manual in addition to the standard parameters for Voiceband circuits.

- (1) Attenuation distortion with reference to 1004 Hz.
- (2) Envelope delay distortion.

Applies to All Exchanges Illinois

FACILITIES FOR INTRASTATE ACCESS

5. SPECIAL ACCESS (Cont'd)5.4 Description of Supplemental Features (Cont'd)5.4.2 Conditioning Arrangements - Data (Cont'd)(A) Type C (Cont'd)

The customer may choose to order Improved Attenuation Distortion or Improved Envelope Delay Distortion or both configurations. The rates specified for Type C-Improved conditioning, Section 5.7.2, will apply regardless of the configuration specified.

(B) Type DA

Type DA conditioning of Voiceband facilities provides a facility with the following transmission parameter enhanced to meet the values specified for Type DA conditioning in Section 7000 of the Technical Interface Reference Manual in addition to the standard parameters for voiceband circuits.

- (1) Signal to C-notched noise ratio.
- (2) Nonlinear signal to second order distortion.
- (3) Nonlinear signal to third order distortion.

5.4.3 Conditioning - Program Audio(A) Stereo Conditioning

Provides the option of two radio program facilities which are identical in all transmission characteristics. Two Program Audio facilities are required to provide this Supplemental Feature. This feature is normally used only with Program Audio 50 to 15000 Hz facilities. Stereo Conditioning is charged on a per occurrence basis.

(B) Zero Loss

Conditioning of Program Audio facilities to provide zero loss at 1000 Hz test frequency. Zero loss is charged on a per Special Access Line basis.

Applies to All Exchanges Illinois

FACILITIES FOR INTRASTATE ACCESS

5. SPECIAL ACCESS (Cont'd)

5.4 Description of Supplemental Features (Cont'd)

5.4.4 Signaling Arrangements

Signaling arrangements, when furnished with Voiceband transmission facilities, enable the facilities to accommodate standard telecommunications signaling protocols. Signaling arrangements provide for the conversion of one signaling method to another signaling method and/or extension of a signaling method at customer and Telephone Company interfaces and enables the transmission facilities to accommodate signaling transmission. Signaling arrangements are available with Voiceband transmission facilities to enable transmission of requested signaling formats. The third and fourth protocol characters of the Network Channel Interface (NCI) and Secondary Network Channel Interface (SEC NCI) codes as indicated on the customer's order, reflect signaling activity. Typical protocol characters contained in the NCI or SEC NCI codes that designate signaling arrangements are: AB, AC, DS, DX, DY, EA, EB, EC, EX, GO, GS, LA, LB, LC, LO, LR, LS, NO, RV and SF.

The customer identified NCI and SEC NCI codes will be considered the customer's request for signaling. The Telephone Company will endeavor to provide the specific signaling protocols requested by the customer. In those cases where facilities and equipment are not available to meet the customer's specific requests, the Telephone Company will provide the customer acceptable alternate protocols. Sections 3300, 6000 and 7000 of the Technical Interface Reference Manual provide detailed technical descriptions of the signaling protocols normally available with each service offering. To properly provision SF signaling, when associated signaling code, is DS (PCM), additional information of SF requirements (loop signaling type DX/E&M or ringdown) must accompany the customer's order.

Signaling arrangement charges apply whenever interfaces at the customer premises or at the customer's Telephone Company serving wire center require a signaling arrangement other than those provided with the Terminating Options in 5.3.2 preceding. Signaling Arrangements will be charged on a per SAL basis. Specifically, a signaling charge applies if the signaling protocol characters in the NCI and the SEC NCI fields are different and include one of the following codes: RV, EX, SF, DX, DY, DS, AB.

Applies to All Exchanges Illinois

FACILITIES FOR INTRASTATE ACCESS5. SPECIAL ACCESS (Cont'd)5.4 Description of Supplemental Features (Cont'd)5.4.4 Signaling Arrangements (Cont'd)

For the above conditions, one additional signaling charge applies for each additional leg of multipoint circuit. When a Multiplexing Arrangement is ordered that converts a single higher capacity or bandwidth circuit into several lower Voiceband circuits, the Voiceband Signaling Arrangements are provided as part of the Multiplexing Arrangement, and no additional Signaling Arrangement charges will apply.

A signaling charge applies in addition to any other applicable signaling charge when loop range extension equipment is required. The Telephone Company will obtain customer approval for signaling range extension equipment.

Listed below are the Signaling Arrangements offered under this tariff:

- (A) Loop Signaling Range Extension - An arrangement to extend the metallic resistance limitations of loop type signaling.
- (B) Conversion of Loop or E&M Signaling to SF - An arrangement to convert loop or E&M signaling to the single frequency signaling format.
- (C) E&M to DX Signaling Conversion - Conversion of E&M signaling to the DX signaling format.
- (D) E&M to Loop Signaling Conversion - Conversion of E&M signaling format to the loop type signaling.
- (E) Loop or E&M to PCM Signaling - Conversion of loop or E&M signaling to the digital (PCM) signaling format.
- (F) Automatic Ringdown Signaling (ARD) - A signaling arrangement on a two-point Special Access which converts loop seizure at one end of the facility into ringing signal at the opposite end.

Applies to All Exchanges Illinois

FACILITIES FOR INTRASTATE ACCESS

5. SPECIAL ACCESS (Cont'd)5.4 Description of Supplemental Features (Cont'd)5.4.5 Echo Control(A) Echo Suppression

An arrangement provided at the customer's request to attenuate reflected speech energy on a four-wire facility. This conditioning is generally required on circuits with long propagation delay. Echo suppression is charged on a per Special Access circuit basis. Echo suppression is an obsolete service offering and is applicable only to those circuits equipped with echo suppression prior to January 1, 1987. Any service rearrangements or order activity on the circuits equipped with echo suppression may require a change to echo canceler as described in 5.4.5(B) following.

(B) Echo Canceler

An arrangement provided at the customer's request to cancel reflected speech energy on a four-wire facility. This conditioning is generally required on circuits with long propagation delay. Echo canceler is charged on a per Special Access circuit basis.

5.4.6 Improved Return Loss

Improved Return Loss provides for increased echo return and singing return parameters of an effective two-wire channel. This optional feature is available with certain Voiceband services at a two-wire point of termination when the transmission interface is four-wire at one CDL and two-wire at the other CDL. Placement of Telephone Company equipment may be required at the customer's premises with the two-wire point of termination.

Improved Return Loss rates and charges will apply on a per Special Access Line basis at the rates specified in this tariff. Technical parameters and the applicable Voiceband services are specified in Section 7000 of the Technical Interface Reference Manual.

Applies to All Exchanges Illinois

FACILITIES FOR INTRASTATE ACCESS

5. SPECIAL ACCESS (Cont'd)

5.4 Description of Supplemental Features (Cont'd)

5.4.7 Voiceband Facility Switching Arrangement

An arrangement to provide switching between two Voiceband Special Access Services. This arrangement may require a Voiceband control circuit to control the switching arrangement at an additional charge.

5.4.8 Automatic Protection Switch

Consists of the special switching equipment placed at both ends of a duplicate DS1 facility (i.e., DS1, High Capacity Circuit) for automatic switching to the duplicate (standby) facility in the event the active facility is inoperative.

Duplicate facilities may terminate at a serving wire center, a CDL or both. The option provided under this tariff only includes the APS(s) located at a serving wire center(s). When the duplicate facility terminates at a CDL, the customer will be responsible for providing the associated APS and ensuring it is compatible with the Telephone Company provided switch if appropriate.

The duplicate facilities are not a part of this supplemental feature.

5.4.9 Improved Termination Option

Improved Termination provides for a fixed 600 ohm impedance, an increased range of transmission levels, and simplex reversal (when applicable) on an effective four-wire channel. This optional feature is available with most Voiceband services with a four-wire point of termination. Telephone Company equipment is required at the customer's premises where this option is ordered.

The Improved Termination option will be ordered and rates and charges, as set forth in this tariff, will apply on a per SAL basis. Technical parameters and the applicable Voiceband services are specified in Section 7000 of the Technical Interface Reference Manual.

Applies to All Exchanges Illinois

FACILITIES FOR INTRASTATE ACCESS

5. SPECIAL ACCESS (Cont'd)

5.4 Description of Supplemental Features (Cont'd)

5.4.10 Improved Equal Level Echo Path Loss Option - ELEPL-2

This option provides improved echo control parameters for an effective two-wire channel at a four-wire point of termination. Placement of Telephone Company equipment may be required at the customer's premises with the two-wire point of termination.

The term "Equal Level Echo Path Loss" (ELEPL) represents the measure of Echo Path Loss (EPL) at a four-wire interface which is corrected by the difference between the send and receive Transmission Level Point (TLP), i.e., $ELEPL = EPL - TLP(\text{send}) + TLP(\text{receive})$.

Improved ELEPL rates and charges will apply on a per SAL basis at the rates set forth in this tariff following. Technical parameters are specified in Section 7000 of the Technical Interface Reference Manual.

5.5 Description of Multiplexing Arrangements

Multiplexing Arrangements provide the function to convert a single higher capacity or bandwidth circuit for bulk transport to several lower capacity or bandwidth circuits. Cascading multiplexing occurs when a high capacity analog or digital channel is de-multiplexed to provide channels with a lesser capacity and one of the lesser capacity channels is further de-multiplexed. For example, a DS1C may be de-multiplexed to two DS1 facilities and then the DS1 facilities may be further de-multiplexed to 24 Voiceband channels.

When cascading multiplexing is performed in the same or different Hub Wire Center, a charge for the additional multiplexing unit will also apply. When cascading multiplexing is performed at a different Hub Wire Center, Special Transport will also apply between the involved Hub Wire Centers.

Applies to All Exchanges Illinois

FACILITIES FOR INTRASTATE ACCESS

5. SPECIAL ACCESS (Cont'd)5.5 Description of Multiplexing Arrangements (Cont'd)(A) Group to Voice

An arrangement that multiplexes twelve voice grade circuits to a single wideband analog group band circuit, or multiplexes a single wideband analog group band circuit to twelve voice grade circuits.

(B) Supergroup to Group

An arrangement that multiplexes five wideband analog group band circuits to a single wideband analog supergroup band circuit, or multiplexes a single wideband analog supergroup band circuit to five wideband analog group band circuits.

(C) Mastergroup to Supergroup

An arrangement that multiplexes ten wideband analog supergroup band circuits to a single wideband analog mastergroup band circuit, or multiplexes a single wideband analog mastergroup band circuit to ten wideband analog supergroup band circuits.

(D) DS1 to Voice

An arrangement that multiplexes twenty-four voice grade circuits to a single DS1 digital circuit at a rate of 1.544 Mbps, or multiplexes a single DS1 digital circuit at a rate of 1.544 Mbps to twenty-four voice grade circuits. If this DS1 terminates in a DDS hub, a channel(s) of the DS1 can be used to provide DDS; however, DDS service stops at the DS1 interface. Multiple channels may be required to provide individual Program Audio Channels.

Up to 16 channels of this DS1 can be used for Direct Digital Service (DDS-like service) with the assurance that circuit performance parameters will be met. If more than 16 channels are used for DDS-like service, the performance parameters for the DS1 and all circuits riding the DS1 will not be guaranteed.

FT1 can be used in conjunction with DS1 to Voice Multiplexing in groupings of $N \times 56$ Kbps or $N \times 64$ Kbps where $N = 2, 4$ or 6 , to a single DS1 digital circuit at a rate of 1.544 Mbps.

Applies to All Exchanges Illinois

FACILITIES FOR INTRASTATE ACCESS

5. SPECIAL ACCESS (Cont'd)

5.5 Description of Multiplexing Arrangements (Cont'd)

(E) DS1C to Voice

An arrangement that multiplexes forty-eight voice grade circuits to a single DS1C digital circuit at a rate of 3.152 Mbps, or multiplexes a single DS1C digital circuit at a rate of 3.152 Mbps to forty-eight voice grade circuits.

(F) DS1C to DS1

An arrangement that multiplexes two DS1 digital circuits to a single DS1C digital circuit at a rate of 3.152 Mbps, or multiplexes a single DS1C digital circuit at a rate of 3.152 Mbps to two DS1 digital circuits.

(G) DS3 to DS1

An arrangement that multiplexes twenty-eight DS1 digital circuits to a single DS3 digital circuit at a rate of 44.736 Mbps, or multiplexes a single DS3 digital circuit at a rate of 44.736 Mbps to twenty-eight DS1 digital circuits.

(H) DS3C to DS1

An arrangement that multiplexes fifty-six DS1 digital circuits to a single DS3C digital circuit at a rate of 89.472 Mbps, or multiplexes a single DS3C digital circuit at a rate of 89.472 Mbps to fifty-six DS1 digital circuits.

(I) Group to DS1

An arrangement that multiplexes two wideband analog groupband circuits to a single DS1 digital circuit at a rate of 1.544 Mbps, or multiplexes a single DS1 digital circuit at a rate of 1.544 Mbps to two wideband analog groupband circuits.

(J) Digital Data Carrier Multiplexer

An arrangement that multiplexes a single DS1 1.544 Mbps digital circuit to twenty-three DSO digital ports for connection to either subrate data multiplexer as described in 5.5(K) following or 56 kbps digital circuits.

Applies to All Exchanges Illinois

FACILITIES FOR INTRASTATE ACCESS

5. SPECIAL ACCESS (Cont'd)5.5 Description of Multiplexing Arrangements (Cont'd)(K) Digital Data Subrate Multiplexer

Used with cascading multiplexing, the Digital Data Subrate Multiplexer is an arrangement that multiplexes the following quantities of subrate digital data circuits into a single DSO digital port: 1) twenty 2.4 Kbps, 2) ten 4.8 Kbps or 3) five 9.6 Kbps. In turn, the DSO digital port is then multiplexed to a single DS1 digital circuit using the Digital Data Carrier Multiplexer described in 5.5(L) preceding.

5.6 Rate Regulations

This section contains specific regulations governing the rates and charges that apply for Special Access Service.

5.6.1 Types of Rates and Charges

There are four types of rates and changes. These are monthly rates, daily rates, hourly rates and nonrecurring charges. The rates and charges are described as follows:

(A) Monthly Rates

Monthly rates are recurring charges that apply each month or fraction thereof that a Special Access Service is provided. For billing purposes, each month is considered to have 30 days.

(B) Daily Rates

Daily rates are recurring charges that apply to each 24 hour period or fraction thereof that a part-time Program Audio Special Access Service is provided. This 24 hour period is not limited to a calendar day. When part-time Program Audio service is provided for ten or more consecutive days it will be treated as a full-time service and monthly rates will apply. In no event will the charges for continuous part-time Program Audio service exceed the amount that would be charged in the same time period for full-time service.

Applies to All Exchanges Illinois

FACILITIES FOR INTRASTATE ACCESS

5. SPECIAL ACCESS (Cont'd)5.6 Rate Regulations (Cont'd)

This section contains specific regulations governing the rates and charges that apply for Special Access Service.

5.6.1 Types of Rates and Charges(C) Time Sensitive Rates

Time sensitive rates are charges that are applied either on an hourly basis or on a fraction of an hour basis.

(1) Hourly Rates

Hourly rates are recurring charges that apply to each 60 minute period, or fraction thereof, that a part-time Videoband - Type I Special Access Service is provided. The billing period commences when the video circuit is available for the customer's use and ceases when the customer's use is discontinued. There is a maximum monthly charge that may be assessed to any Temporary Videoband - Type I Special Access Service. The maximum charge during any 30 day period will be that amount equal to 100 hours of use.

(D) Zone Density Plan - Special Access

The Zone Density Rate Plan is a pricing unit for rating High Capacity Special Access DS1 and DS3 Services. The Zone Density Plan assigns every Serving Wire Center (SWC) to one of three zones. The Serving Wire Center, CLLI Codes and zones are listed in Section 18. Zone 1/Band A SWCs have the highest density of services, Zone 2/Band B SWCs have intermediate density of services and Zone 3/Band C SWCs have the lowest density of services. Zone Density Plan rates become effective in a study area concurrent with the first operational Expanded Interconnection Service (EIS) in that study area.

Applies to All Exchanges Illinois

FACILITIES FOR INTRASTATE ACCESS

5. SPECIAL ACCESS (Cont'd)

5.6 Rate Regulations (Cont'd)

5.6.1 Types of Rates and Charges (Cont'd)

(D) Zone Density Plan - Special Access (Cont'd)

The Zone Density Plan for Special Access is applicable only to DS1 (1.544 Mbps) and DS3 (44.736 Mbps) services.

(1) Zone Density rates are set for in Sections:

- 5.7.6 - Multiplexing Arrangements
- 5.7.7 - High Capacity Digital DS1
- 5.7.10 - High Capacity Digital DS3 Three System
- 5.7.11 - High Capacity Digital DS3 Unlimited System
- 5.7.12 - High Capacity Digital DS3 Individual System
- 5.7.13 - High Capacity Digital DS3 Group System*
- 5.7.14 - High Capacity Digital DS3 Transport
- 5.7.15 - DS3 Multiplexer Cross Connect Arrangement
- 5.7.17 - DS1 Term Volume Plan
- 5.8.1 - Clear Channel Capability

(2) Special Access Lines and Transport Terminations are rated according to the Zone of the SWC where they are located.

(3) Special Transport provisioned between SWCs in two different zones will be rated at the higher zone rate.

(4) Zone Density Plan for special access provided by more than one telephone company will be provided as set forth in Section 2.7.4.

(E) Nonrecurring Charges

Nonrecurring charges are one-time charges that apply for specific work activity, (i.e., installation of service or change to an existing service). The types of nonrecurring charges that apply for Special Access Service are those listed below.

*Limited to those services so equipped and in service as of March 25, 1999.

Applies to All Exchanges Illinois

FACILITIES FOR INTRASTATE ACCESS

5. SPECIAL ACCESS (Cont'd)5.6 Rate Regulations (Cont'd)5.6.1 Types of Rates and Charges (Cont'd)(E) Nonrecurring Charges (Cont'd)(1) Design Change Charge

The customer may request a design change to the service ordered. A design change is any change to a pending ASR for Special Access Service which requires engineering review. Design changes include such things as the addition or deletion of supplemental features or changes in the terminating options. Design changes do not include a change of IC CDL or end user premises when its serving wire center changes or Special Access service type (e.g., 2-wire to 4-wire Voiceband or Voiceband to Program Audio, etc.). Changes of this nature will require the issuance of a new ASR and the cancellation of the original ASR. The cancellation charges apply as set forth in 3.2.6 preceding.

The Telephone Company will review the requested change, notify the customer whether the change can be accommodated and specify if a new service date is required. If the customer authorizes the Telephone Company to proceed with the design change, a Design Change Charge will apply.

The Design Change Charge, as set forth in 5.7.1 following, will apply on a per ASR per occurrence basis, for each ASR requiring a design change.

If a change of service date is required, the Service Date Change Charge as set forth in Section 3 preceding will also apply.

Applies to All Exchanges Illinois

FACILITIES FOR INTRASTATE ACCESS

5. SPECIAL ACCESS (Cont'd)5.6 Rate Regulations (Cont'd)5.6.1 Types of Rates and Charges (Cont'd)(E) Nonrecurring Charges (Cont'd)(2) Installation of Supplemental Features and Multiplexing Arrangements

Nonrecurring charges apply for the installation of supplemental features and multiplexing arrangements available with Special Access service. The charge applies whether the feature or multiplexing arrangement is installed coincident with the initial installation of service or at any time subsequent to the installation of service.

For additions of supplemental features without an NRC, a charge equal to a SAL NRC will apply. Only one such charge per service, per order will apply.

(3) Installation of FiberConnect, FT1, DS3 and DS1 Special Access Lines(a) FiberConnect Service Optional Payment Plan (OPP) Arrangement

Customers subscribing to the FiberConnect OPP arrangements, at rates set forth in 5.7.8, will be assessed a nonrecurring charge. The NRC represents the termination of four DS1 equivalent SALs on a single fiber optic transmission system. The customer must order four DS1s and indicate on the ASR the Network Channel Interface (NCI) code for either electrical or fiber optic termination.

The NRC for installation of a FiberConnect OPP SAL as set forth in 5.7.8(A) or (B) will apply to existing FiberConnect OPP customers when required for changes and other service rearrangements as set forth in 5.6.1(E).

(b) Fractional T1 Standard Arrangements

Customers subscribing to the Fractional T1 service, at rates set forth in 5.7.9(A), will be assessed a nonrecurring charge. The NRC for Fractional T1 service will be assessed per SAL.

Applies to All Exchanges Illinois

FACILITIES FOR INTRASTATE ACCESS

5. SPECIAL ACCESS (Cont'd)5.6 Rate Regulations (Cont'd)5.6.1 Types of Rates and Charges (Cont'd)(E) Nonrecurring Charges (Cont'd)(3) Installation of FiberConnect, FT1, DS3 and DS1 Special Access Lines(c) Fractional T1 Optional Payment Plan (OPP) Arrangements

Customers subscribing to the Fractional T1 OPP arrangements, at rates set forth in 5.7.9(B), will not be assessed a nonrecurring charge.

The regulations in Section 5.6.1(E) will apply to existing FT1 OPP customers when required for changes and other service rearrangements.

(d) DS3 Arrangements

There are two levels of charges for the installation of 3 System DS3 and Unlimited System DS3 SALs as set forth in 5.7.10 and 5.7.11. The "First System" charge is assessed for the first DS3 SAL ordered by a customer. When the same customer requests additional DS3 SALs, to be installed between the same locations, the "Additional System" charge will apply for each SAL ordered (maximum of two Additional System SALs in a 3 System DS3 and no maximum in an Unlimited System DS3).

For Individual DS3s, the charge for installation will apply at the same rate per DS3 SAL, and for Group System DS3s*, the charge applies per Group System* SAL.

*Limited to those services so equipped and in service as of March 25, 1999.

Applies to All Exchanges Illinois

FACILITIES FOR INTRASTATE ACCESS

5. SPECIAL ACCESS (Cont'd)5.6 Rate Regulations (Cont'd)5.6.1 Types of Rates and Charges (Cont'd)(E) Nonrecurring Charges (Cont'd)(3) Installation of FiberConnect, FT1, DS3 and DS1 Special Access Lines
(Cont'd)(e) DS1 Standard Arrangements

Customers subscribing to DS1 Standard Arrangements, at rates set forth in 5.7.7(A), will be assessed a nonrecurring charge. The NRC for DS1 Standard Arrangements will be assessed per SAL.

The regulations in Section 5.6.1(E)(6) will apply to existing DS1 Standard Arrangements customers when required for changes and other service rearrangements.

(4) Installation of Temporary Videoband Service(a) Temporary Videoband Service - Type I

There are two nonrecurring charges set forth in Section 5.7.4(A) for the installation of Temporary Videoband Service - Type I. One nonrecurring charge will be assessed when permanent in place facilities are used to provide the service, and a different nonrecurring charge will be assessed when nonpermanent portable facilities are used to provide the service.

If the customer orders Temporary Videoband Service - Type I with broadcast intervals of 5 nonconsecutive days or less within a 7-day period, the Telephone Company may, if facilities are available, leave the facilities in place, in which case the associated installation nonrecurring charges would not apply.

Applies to All Exchanges Illinois

FACILITIES FOR INTRASTATE ACCESS

5. SPECIAL ACCESS (Cont'd)5.6 Rate Regulations (Cont'd)5.6.1 Types of Rates and Charges (Cont'd)(E) Nonrecurring Charges (Cont'd)(5) Installation of Voicegrade, Program Audio and Digital Data Service Special Access Line

The nonrecurring charge associated with the installation of voicegrade SALs is specified in this tariff. The nonrecurring charge associated with the installation of program audio SALs is specified in in this tariff through (D). This charge will not apply to part-time Program Audio SALs which are left in place and reused.

The nonrecurring charge associated with the installation of DDS SAL facilities and the provisioning of the Customer specified transmission speed of 2.4, 4.8, 9.6, 19.2, 56 or 64 Kbps is specified in Section 5.7.5.

(6) Service Rearrangements

Service rearrangements are changes to existing (installed) services which may be administrative only in nature or involve an actual physical change to the service. Changes to pending orders are in Section 3.

Changes in the type of service will be treated as a discontinuance of the service and an installation of a new service.

Changes in the physical location of the point of termination are treated as moves which are described and charged for as in 5.6.4.

Applies to All Exchanges Illinois

FACILITIES FOR INTRASTATE ACCESS

5. SPECIAL ACCESS (Cont'd)

5.6 Rate Regulations (Cont'd)

5.6.1 Types of Rates and Charges (Cont'd)

(E) Nonrecurring Charges (Cont'd)

Administrative changes will be made without charge(s) to the customer.

Administrative changes are as follows:

- Change in name or ownership or transfer of responsibility from one customer to another, provided there is not interruption of use or relocation of Special Access service.
- Change of customer or customer's end user premises address when the change of address is not a result of a physical relocation of equipment,
- Change in billing data (name, address, or contact name or telephone number),
- Change of customer circuit identification,
- Change of billing account number,
- Change of customer test line number,
- Change of customer or customer's end user contact name or telephone number,
- Change of agency authorization, and
- Change in jurisdiction involving no physical changes to the service.

Applies to All Exchanges Illinois

FACILITIES FOR INTRASTATE ACCESS

5. SPECIAL ACCESS (Cont'd)5.6 Rate Regulations (Cont'd)5.6.1 Types of Rates and Charges (Cont'd)(E) Nonrecurring Charges (Cont'd)(6) Service Rearrangements (Cont'd)

All other service rearrangements will be charged for as follows:

- If the change involves the addition of another termination to an existing two-point or multipoint service, installation charges for each location added will apply.
- If the change involves the addition of supplemental feature or multiplexing arrangement, the installation charge associated with the supplemental feature or multiplexing arrangement will apply. When the supplemental feature or arrangement has no associated nonrecurring charge (or rated at \$.00), one SAL nonrecurring charge for the type of service involved (i.e., voice grade SAL, DDA SAL, etc.) will be applied to the order.
- If the change involves only changing the type of network interface, with no change in facility, the installation charge associated with each service receiving a network interface change will apply.
- If the change involves changing a two-wire service to a four-wire service or vice versa, the installation charge for each location changed will apply.
- If the change involves only rollovers or grooming, then no charges will apply. A rollover is the retermination of a segment of a lower capacity special access service onto a higher capacity special access service. The rollover must occur in the wire center where the higher capacity service is multiplexed with no other changes to the lower capacity service being reterminated (i.e., the segment must not require rerouting to connect to the multiplexer of the higher capacity service).

Applies to All Exchanges Illinois

FACILITIES FOR INTRASTATE ACCESS

5. SPECIAL ACCESS (Cont'd)

5.6 Rate Regulations (Cont'd)

5.6.1 Types of Rates and Charges (Cont'd)

(E) Nonrecurring Charges (Cont'd)

(6) Service Rearrangements (Cont'd)

- Grooming is the retermination of a lower capacity special access service from one channel in a higher capacity special access service to another channel in the same higher capacity service or to another channel in another higher capacity special access service (i.e., change in connecting facility assignment) in the same wire center, with no other changes to the lower capacity service.

Rollover - Example 1

Current Configuration

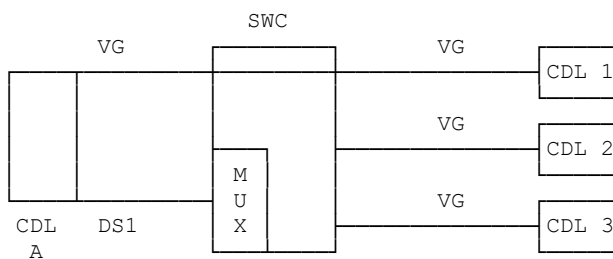

The customer requests that the voiceband circuit (VG) between CDL A and CDL 1 be "rolled over" to the DS1 Serving CDL A. No NRCs apply for this request.

Applies to All Exchanges Illinois

FACILITIES FOR INTRASTATE ACCESS

5. SPECIAL ACCESS (Cont'd)

5.6 Rate Regulations (Cont'd)

5.6.1 Types of Rates and Charges (Cont'd)

(E) Nonrecurring Charges (Cont'd)

(6) Service Rearrangements (Cont'd)

Rollover - Example 1

New Configuration

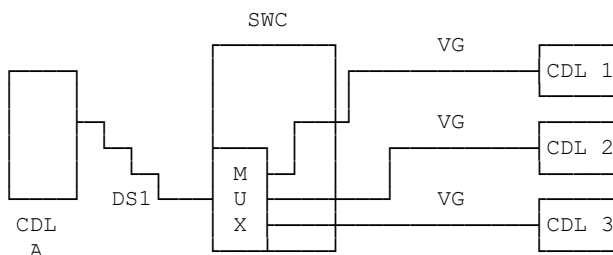

Applies to All Exchanges Illinois

FACILITIES FOR INTRASTATE ACCESS

5. SPECIAL ACCESS (Cont'd)

5.6 Rate Regulations (Cont'd)

5.6.1 Types of Rates and Charges (Cont'd)

(E) Nonrecurring Charges (Cont'd)

(6) Service Rearrangements (Cont'd)

Rollover - Example 2

Current Configuration

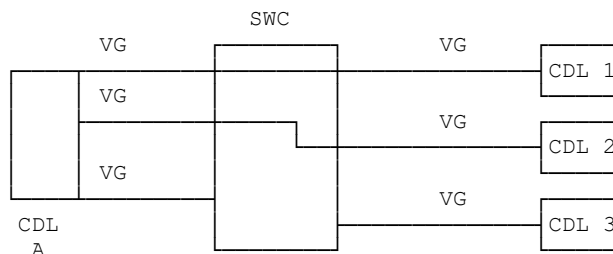

The customer requests the installation of a DS1 between the serving wire center (SWC) and CDL A and a DS1/voice multiplexer in the SWC. The customer also requests that the voiceband circuits serving CDLs 1, 2, and 3 be "rolled over" to the new DS1. All NRCs apply for the installation of the DS1 and multiplexer. No NRCs apply for the voiceband roll overs to the new high capacity circuit.

Applies to All Exchanges Illinois

FACILITIES FOR INTRASTATE ACCESS

5. SPECIAL ACCESS (Cont'd)

5.6 Rate Regulations (Cont'd)

5.6.1 Types of Rates and Charges (Cont'd)

(E) Nonrecurring Charges (Cont'd)

(6) Service Rearrangements (Cont'd)

Rollover - Example 2

New Configuration

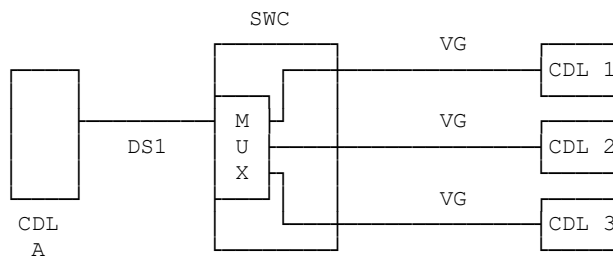

Applies to All Exchanges Illinois

FACILITIES FOR INTRASTATE ACCESS

5. SPECIAL ACCESS (Cont'd)

5.6 Rate Regulations (Cont'd)

5.6.1 Types of Rates and Charges (Cont'd)

(E) Nonrecurring Charges (Cont'd)

(6) Service Rearrangements (Cont'd)

GROOMING - Example 1

Current Configuration

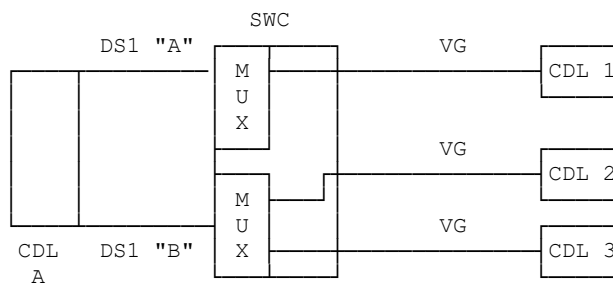

The customer requests that the voiceband (VG) circuit serving CDL 1 be moved from the DS1 "A" circuit to the DS1 "B" circuit. No NRCs apply for this request.

GROOMING - Example 1

New Configuration

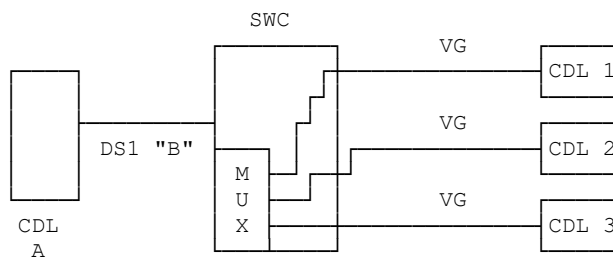

Applies to All Exchanges Illinois

FACILITIES FOR INTRASTATE ACCESS

. SPECIAL ACCESS (Cont'd)

5.6 Rate Regulations (Cont'd)

5.6.1 Types of Rates and Charges (Cont'd)

(E) Nonrecurring Charges (Cont'd)

(6) Service Rearrangements (Cont'd)

GROOMING - Example 2

Current Configuration

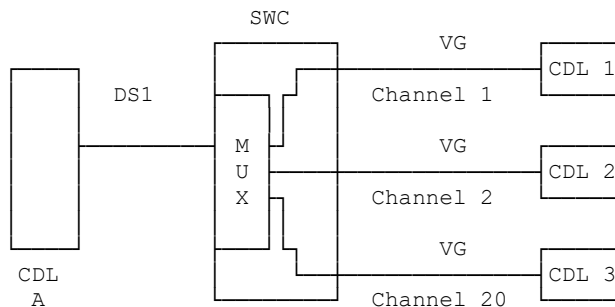

The customer requests that the voiceband circuit serving CDL 3 be moved from Channel 20 in the DS1 serving CDL A to Channel 3 in the same DS1. No NRCs apply for this request.

Applies to All Exchanges Illinois

FACILITIES FOR INTRASTATE ACCESS

. SPECIAL ACCESS (Cont'd)5.6 Rate Regulations (Cont'd)5.6.1 Types of Rates and Charges (Cont'd)(E) Nonrecurring Charges (Cont'd)(6) Service Rearrangements (Cont'd)

GROOMING - Example 2

New Configuration

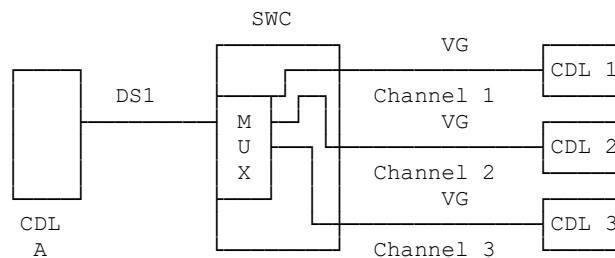

- If the change involves reterminations other than Rollovers and/or Grooming, all NRCs associated with the installation of the lower capacity service.
- In cases where multiple service rearrangements or an additional termination or a move and a service rearrangement are requested on a single ASR, the total charge will never exceed the full nonrecurring charge for the basic service.

Applies to All Exchanges Illinois

FACILITIES FOR INTRASTATE ACCESS

5. SPECIAL ACCESS (Cont'd)5.6 Rate Regulations (Cont'd)5.6.2 Minimum Periods

Special Access is provided for a specified minimum period. Minimum periods and minimum period charges are described in Section 3 preceding.

5.6.3 Mileage Measurement

The mileage to be used to determine the monthly rate for the Special Transport is calculated on the airline distance between the serving wire centers involved (i.e., CDL serving wire center or Hub Wire Center or WATS Serving Office). Where the calculated miles include a fraction, the value is always rounded up to the next full mile. Where the calculated value is zero, no Special Transport mileage is charged.

When there is a Hub Wire Center involved, the Special Transport mileage will be measured from the Hub Wire Center to the serving wire centers of each of the CDLs connected to the hubbed facilities. Mileage is computed for each section and rates are applied accordingly. However, when a Special Access facility is routed through a Hub Wire Center for purposes other than customer specified such as bridging or multiplexing (e.g., the Telephone Company chooses to so route for test access purposes), rates will be applied only to the distance calculated between the wire centers serving the CDLs.

The rates for the mileage are applied per airline mile. The serving wire center V&H coordinates and the method of calculation are specified in the NECA Tariff FCC No. 4.

5.6.4 Moves

A move involves a change in the physical location of the point of termination of Special Access. A move normally involves an interruption of Special Access for the period required to complete the move. No credit allowance will be granted for that period. Special Construction as set forth in Section 10 may also be applicable at the different CDL.

Applies to All Exchanges Illinois

FACILITIES FOR INTRASTATE ACCESS

5. SPECIAL ACCESS (Cont'd)

5.6 Rate Regulations (Cont'd)

5.6.4 Moves (Cont'd)

A customer may request that Special Access not be interrupted during a move. To comply with that request, it may be necessary to install a duplicate Special Access, and subsequently discontinue the existing Special Access. Charges, monthly and nonrecurring, will apply for the duplicate Special Access. A new minimum period will be established for the duplicate portion of the Special Access, depending on which end of the Special Access is moved. The customer will remain responsible for all minimum period charges associated with the corresponding portion of the disconnected Special Access.

The charge for the move depends on whether the move is within the same CDL or to a different CDL.

(A) Same CDL

When the move of a termination of FIA, as defined in Section 2.1.5, for special access is to a new point within the same CDL (same address and/or same building), the charge for the move will be the installation charge for the portion of the service being reterminated. There will be no change in the minimum period requirements. For services subject to payment plan regulations, the same payment period will remain in force.

Applies to All Exchanges Illinois

FACILITIES FOR INTRASTATE ACCESS

5. SPECIAL ACCESS (Cont'd)

5.6 Rate Regulations (Cont'd)

5.6.4 Moves (Cont'd)

(B) Different CDL

- (1) When the move is to a different CDL (different address and different building), except as specified below, it will be treated as a disconnect and an installation of service. The appropriate service installation charge for the service termination(s) affected will apply. A new minimum period will be established for the installed Special Access Service. The customer will remain responsible for all minimum period charges associated with the disconnected Special Access Service. For services subject to payment plan regulations, a new payment plan will be established and full assessment of the remaining liabilities will be applicable.
- (2) When the move is to a different CDL but served by the same serving wire center, the following conditions apply:
 - A change ASR will be required.
 - The appropriate service installation charge for the service termination(s) affected will apply.
 - For Special Access services subject to payment plan regulations, if the customer of record remains the same with no lapse in service, the appropriate NRCs for changes will apply. Otherwise, the move will be treated as a disconnect and an installation of service and all appropriate NRCs and full assessment of the remaining liabilities will be applicable.

Applies to All Exchanges Illinois

FACILITIES FOR INTRASTATE ACCESS

5. SPECIAL ACCESS (Cont'd)

5.6 Rate Regulations (Cont'd)

5.6.5 Rates and Charges on an Individual Case Basis

(A) The monthly rates and nonrecurring charges for the following service offerings will be developed on an Individual Case Basis:

- Full-time Videoband - Type I Facilities
- Wideband Analog - Group Band Facilities
- Wideband Analog - Supergroup Band Facilities
- Wideband Analog - Mastergroup Band Facilities
- High Capacity Digital DS1C (3.152 Mbps) Special Access Lines
- High Capacity Digital DS1C (3.152 Mbps) Special Transport
- High Capacity Digital DS3C (89.472 Mbps) Facilities

(B) The monthly rates and nonrecurring charges for the following Multiplexing Arrangements will be developed on an Individual Case Basis:

Group to Voice
Supergroup to Group
Mastergroup to Supergroup
DS1C to Voice
DS1C to DS1
DS3C to DS1
Group to DS1

(C) The monthly rates and nonrecurring charges for the following Supplemental Features will be developed on an Individual Case Basis:

Dataphone Select-a-Station Bridging Common Equipment - Addressable

Dataphone Select-a-Station Bridging - Each Four-Wire Port

(D) Alternate payment arrangements for tariffed services may be made on an Individual Case Basis. A listing of customers and specific payment arrangements.

Applies to All Exchanges Illinois

FACILITIES FOR INTRASTATE ACCESS

5. SPECIAL ACCESS (Cont'd)

5.6 Rate Regulations (Cont'd)

5.6.6 Hub Wire Centers

A Hub Wire Center is a Telephone Company designated serving wire center at which bridging or multiplexing arrangements are provided. Bridging is used to connect three or more CDLs in a multipoint arrangement. The multiplexing arrangements channelize analog or digital facilities to individual services requiring a lower capacity or bandwidth.

Although Hub Wire Centers are defined as serving wire centers at which bridging or multiplexing arrangements are performed, they are not limited to providing these functions and may provide any other types of Special Access services offered in this Tariff. For example, the Telephone Company will designate certain Hub Wire Centers for Program Audio service offerings and the termination of Group System DS3* Special Transport.

The Telephone Company will designate the Hub Wire Center locations. Different locations may be designated as Hub Wire Centers for different functions, such as bridging or multiplexing arrangements, for different facility capacities (e.g., multiplexing from digital to digital may occur at one wire center while multiplexing from digital to analog may occur at a different wire center). The location of Hub Wire Centers and the types of hubbing functions offered at that location are identified in the NECA Tariff FCC No. 4.

Some of the types of multiplexing provided include the following:

- from higher to lower bit rate,
- from higher to lower bandwidth,
- from digital to voice grade service.

Applies to All Exchanges Illinois

FACILITIES FOR INTRASTATE ACCESS

5. SPECIAL ACCESS (Cont'd)

5.6 Rate Regulations (Cont'd)

5.6.6 Hub Wire Centers (Cont'd)

The transmission performance for the end to end Special Access provided from CDLs will be that of the lower capacity or bit rate. For example, when a DS1 Special Access is multiplexed to voice frequency circuits, the transmission performance will be Voiceband, not High Capacity.

The Telephone Company will commence billing the monthly rate for the Special Access Line and Special Transport or Special Access Cross Connect charge for EIS arrangements, for the High Capacity facility to the Hub Wire Center as of the service date, even though individual services utilizing those facilities may not be installed until a later date. If the customer has designated the type of multiplexing to be provided with the High Capacity facility, the nonrecurring charge for the Multiplexing Arrangement will be billed to the same customer at that same time, and the billing for the monthly rate will begin.

Individual Special Access rates (by Special Access type) will apply for the Special Access Line and additional Special Transport facilities (if required) for each channelized Special Access. These will be billed to the customer specified on the ASR as each individual Special Access is installed. The appropriate application of rate elements is specified in this tariff.

A customer may order full-time and/or part-time Program Audio Services between two CDLs, or between a CDL and a Hub Wire Center, and will be billed accordingly at the rates set forth in Sections 5.7.3(A), 5.7.3(B), 5.7.3(C), and 5.7.3(D) following.

*Limited to those services so equipped and in service as of March 25, 1999.

Applies to All Exchanges Illinois

FACILITIES FOR INTRASTATE ACCESS

5. SPECIAL ACCESS (Cont'd)

5.6 Rate Regulations (Cont'd)

5.6.6 Hub Wire Centers (Cont'd)

At the request of the customer, the full-time and/or part-time services provided to a Hub Wire Center may be connected together in the following configurations: full-time to full-time, full-time to part-time, or part-time to part-time.

The rates that apply for Program Audio Services between each CDL and the Hub Wire Center are Special Transport, if applicable, and Special Access Line. In addition, rates for Supplemental Features may be applicable.

5.6.7 Shared Use Analog and Digital High Capacity Services

Monthly charges for a DS1 or DS3 high capacity shared use facility will be apportioned between Switched and Special Access based on the relative proportion of channels used for switched and special access in the following manner.

If the facility is ordered as Special Access, rating as Special Access will continue until such time as a portion of the available capacity is used to provide Switched Access service. As individual channels are activated for Switched Access, monthly charges will be apportioned between Switched and Special Access based on the number of channels used for Switched Access and the number of remaining channels on the Special Access facility according to the following formula:

- The total shared use charge is equal to the Monthly Switched Access Charge times the number of channels used for Switched Access divided by 24 for DS1 or 672 for DS3 plus the monthly Special Access Charge times the number of channels remaining for Special Access divided by 24 for DS1 or 672 for DS3.

If the facility is ordered as Switched Access, rating as Switched Access will continue until such time as a portion of the available capacity is used to provide Special Access service. As individual channels are activated for Special Access, monthly charges will be apportioned between Switched and Special Access based on the number of channels used for Special Access and the number of remaining channels on the Switched Access Facility according to the following formula:

Applies to All Exchanges Illinois

FACILITIES FOR INTRASTATE ACCESS

5. SPECIAL ACCESS (Cont'd)

5.6 Rate Regulations (Cont'd)

5.6.7 Shared Use Analog and Digital High Capacity Services (Cont'd)

- The total shared use charge is equal to the Monthly Special Access Charge times the number of channels used for Switched Access divided by 24 for DS1 or 672 for DS3 plus the monthly Switched Access Charge times the number of channels remaining for Switched Access divided by 24 for DS1 or 672 for DS3.

The monthly Switched and Special Access rate used will be the appropriate rate (Special Access SAL, Transport, Multiplexer and/or Cross Connect Arrangement, and Switched Access Entrance Facility, Direct-Trunked Transport, Multiplexer and/or Cross Connect Arrangement) for the underlying shared use facility, i.e., if the underlying facility is a Special Access DS3 service, the corresponding Switched Access DS3 Transport will be used to determine the Switched Access monthly charges.

Shared use of Special Access Fractional T1 (FT1) and FiberConnect is not available.

5.6.8 Temporary Videoband Service

(A) Type I

The rates and charges for use of facilities for Temporary Videoband - Type I Service are assessed on a per hop basis. A hop is defined as the transporting of a one-way video and associated audio signal(s) in a direct path from a transmitter location to the adjacent receiver location. The distance of a single hop is primarily a factor of the local geographics of the video path, therefore, more than one hop may be required between CDLs. The following diagram depicts a single hop.

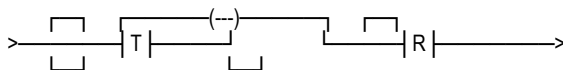

Applies to All Exchanges Illinois

FACILITIES FOR INTRASTATE ACCESS

5. SPECIAL ACCESS (Cont'd)

5.6 Rate Regulations (Cont'd)

5.6.8 Temporary Videoband Service (Cont'd)

There are two separate rate categories for a hop which are based on the provisioning of service:

- Video broadcasts which use permanent facilities, and
- Video broadcasts which use nonpermanent facilities.

(1) Use of Permanent Facilities for Temporary Video Broadcast - Type I

Permanent facilities are those in-place facilities that are not removed at the end of a broadcast. Sites where existing permanent facilities are located for temporary broadcast service are listed in this tariff.

The rates and charges for services provided over permanent facilities for Nonrecurring Charges, for Hourly Charges, and for Technician Standby, are set forth in Section 5.7.4(A). Nonrecurring Charges for Temporary Videoband Service - Type I are also described in Section 5.6.1(E).

The Telephone Company does not contemplate constructing permanent facilities to provision future requests for temporary Type I Videoband service. However, in the event that a customer requests this type of provisioning, as set forth in 5.7.4 following, the Telephone Company will provide such facilities under Section 10, Special Construction. Accordingly, such facilities are deemed to be provided for the sole use of that customer and no other future use of those facilities is planned or expected by the Telephone Company.

Applies to All Exchanges Illinois

FACILITIES FOR INTRASTATE ACCESS

5. SPECIAL ACCESS (Cont'd)5.6 Rate Regulations (Cont'd)5.6.8 Temporary Videoband Service (Cont'd)(A) Type I (Cont'd)

- (2) Use of Nonpermanent Facilities for Temporary Video Broadcast - Type I
Nonpermanent facilities consist of portable microwave equipment (e.g., transmitter, receiver, antenna, connecting cables and associated equipment) which is set up for the broadcast and subsequently removed after the broadcast.

The rates and charges for services provided over nonpermanent facilities for Nonrecurring Charges, for Hourly Charges, and for Technician Standby are set forth in Section 5.7.4 following. Nonrecurring Charges for Temporary Videoband Service - Type I are described in Section 5.6.1(E).

Where multiple hops are required to provide the requested service, the rates and charges will apply to each hop set up for the broadcast. The Technician Standby charge will only apply to the time the Type I Videoband service is provided. The Technician Standby charge is not applied on a per hop basis.

- (3) Use of Combined Facilities for Temporary Video Broadcast - Type I

Temporary Videoband Service may require the use of combined facilities to provide the requested service. Where permanent and nonpermanent facilities are used in tandem to provide a Video service, one-half the nonrecurring charge will apply for the permanent facilities while the full nonrecurring charge will apply for the nonpermanent facilities. The hourly charge for both facilities will be applicable. The Technician Standby charge will only apply to the time the service is provided.

Issued: May 10, 2011

Effective: July 1, 2011

By Kenneth Mason
Vice President
of Government and Regulatory Affairs

Applies to All Exchanges Illinois

FACILITIES FOR INTRASTATE ACCESS

5. SPECIAL ACCESS (Cont'd)

5.6 Rate Regulations (Cont'd)

5.6.8 Temporary Videoband Service (Cont'd)

(A) Type I (Cont'd)

(4) Joint Provisioning of Service

Where more than one Telephone Company is involved in the provisioning of a Temporary Videoband Service - Type I, such jointly provided facilities are subject to the rules and regulations outlined in Sections 2.7 and 3.3. When the multiple bill option is employed as set forth in 2.7.3, the rates will apply as follows: When only nonpermanent facilities are used to provision the service and the service is jointly provided, the rates for the Video service will be one-half the nonrecurring charge and one-half the hourly charge. Where permanent facilities are used to provision the Video service and the service is jointly provided, the rates for the service are the entire nonrecurring charge and the entire hourly charge. Where a combination of permanent and nonpermanent facilities are used in the joint provisioning of the service, the rates for the Video service will be one-half the nonrecurring charge for the permanent and nonpermanent facilities and one-half the hourly charge for the nonpermanent facilities and the entire hourly charge for the permanent facilities.

When a single bill option is employed as set forth in 2.7.3, the rates will apply as follows: Where any combination of permanent and nonpermanent facilities are used to jointly provide the service, the entire nonrecurring charge and the entire hourly charge will apply.

The entire Technician Standby charge will be applied to the time the service is provided under either a single bill option or a multiple bill option.

Applies to All Exchanges Illinois

FACILITIES FOR INTRASTATE ACCESS

5. SPECIAL ACCESS (Cont'd)5.6 Rate Regulations (Cont'd)5.6.9 Special Access Surcharge

Pending the development of techniques to accurately measure usage of local facilities which are interconnected by users by means of intrastate or foreign telecommunications, a surcharge of \$25.00 per service per month will be assessed to a two point Special Access Service, and to each additional Special Access Line when the service is configured as multipoint. The Special Access Surcharge will also be assessed upon Wideband Analog, High Capacity Digital and FT1 Services on a voiceband equivalent basis. The voiceband equivalency for these type services is as follows:

- High Capacity DS1 equates to 24 Voiceband Facilities
- High Capacity DS1C equates to 48 Voiceband Facilities
- High Capacity FiberConnect equates to a maximum of 96 Voiceband Facilities
- High Capacity DS3 equates to 672 Voiceband Facilities
- High Capacity DS3C equates to 1344 Voiceband Facilities
- Wideband Group equates to 12 Voiceband Facilities
- Wideband Supergroup equates to 60 Voiceband Facilities
- Wideband Mastergroup equates to 600 Voiceband Facilities
- Each 56 Kbps or 64 Kbps channel in a FT1 Service equates to one Voiceband Facility.

The Special Access Service will be exempted from the monthly surcharge if the customer provides the Telephone Company written certification that the termination is one of the following:

- (1) The open end termination (dial tone end) of a Foreign Central Office Line, Common Control Switching Arrangement (or equivalent) or Off Network Access Line.
- (2) Any termination of an analog circuit used for radio or television program transmission.
- (3) Any termination of a line used for telex service.

Applies to All Exchanges Illinois

FACILITIES FOR INTRASTATE ACCESS

5. SPECIAL ACCESS (Cont'd)5.6 Rate Regulations (Cont'd)5.6.9 Special Access Surcharge (Cont'd)

- (4) Any termination of a line by nature of its operating characteristics and nature of connection could not make use of common lines.
- (5) Any line termination, other than (1) through (4) preceding, which is subject to the following charges: (a) End Office Switching and (b) Switched Transport.
- (6) A termination that the customer certifies to the Telephone Company is not connected to a PBX or other device capable of interconnecting the Special Access Service to the local network. If the PBX or other device has been configured either through software programming or physical restrictions not to access the local network, then the customer may file the surcharge exemption for the Special Access Service terminating on this equipment.

In order for the Telephone Company to determine the application of the surcharge with respect to specific services, the customer must report the intended use of all services when placing ASRs for Special Access Service. In addition, when ordering High Capacity Analog or Digital services, the customer must report the use for each voice equivalent circuit of the high capacity service. When any circuit is reported wholly used in any manner described in (1) through (6) preceding, the surcharge will not apply. If the intended use is not reported, the surcharge will apply.

If, at any time after the installation of a service which is subject to the surcharge, the customer reports that the service is being used consistently with any exception listed above, the Telephone Company will credit the customer for the surcharge. Credit will not be given beyond the receipt date of the certification for exemption.

Applies to All Exchanges Illinois

FACILITIES FOR INTRASTATE ACCESS5. SPECIAL ACCESS (Cont'd)5.6 Rate Regulations (Cont'd)5.6.10 Message Station Equipment Recovery Charge

Message Station Equipment Recovery Charge is a charge to recover that portion of message station equipment which is assigned to Special Access Service. Since there is zero cost assigned to Message Station Equipment Recovery in Special Access the charge is \$.00.

5.6.11 DS3 High Capacity Service(A) DS3 Rate Structure

Option 1: (System DS3s) SALs are provided as one of two system offerings: 3 System and Unlimited System. SAL rates for system DS3s vary dependent on whether the interface provided is electrical or optical. Additional SALs may only be added with the same interface with Telephone Company electronics or without Telephone Company electronics (electrical or optical) as the First System. All DS3 SALs are non-distance sensitive.

Under a 3 System DS3, additional DS3 SALs, up to a maximum of two, may be ordered by the same customer, between the same CDL and serving wire center.

Under an Unlimited System DS3, additional SALs, with no maximum, may be ordered by the same customer, between the same CDL and serving wire center.

Group System DS3s are limited to those services so equipped and in service as of March 25, 1999. Group System DS3s provide a total capacity of 12 (DS3 x 12) or 24 (DS3 x 24) DS3 SALs. All DS3s in a Group System must be between the same CDL and serving wire center.

Applies to All Exchanges Illinois

FACILITIES FOR INTRASTATE ACCESS

5. SPECIAL ACCESS (Cont'd)

5.6 Rate Regulations (Cont'd)

5.6.11 DS3 High Capacity Service (Cont'd)

(A) DS3 Rate Structure (Cont'd)

Option 2: (Individual DS3) This option provides individual DS3 service. Before confirming the ASR for this option, the Telephone Company will verify the availability of a DS3 interface at the CDL. If a DS3 interface can be made available with no physical change to the existing configuration at the CDL, the ASR will be confirmed and processed. If this condition is not met, the customer will be advised and no charge will be assessed for the unprocessed ASR. The customer may then cancel the ASR or submit a new ASR for one of the services available under Option 1.

SAL rates for Individual DS3s vary dependent on whether the interface provided is electrical or optical.

A DS3 SAL provides a spare transmission path (transmit and receive) connected to an automatic protection switch. In the event of failure in the primary service, traffic will be automatically transferred to the spare transmission facilities. When a customer orders a DS3 SAL, the customer may request that the spare transmission path be provided via an alternate route provisioned as the Telephone Company may elect. If common points for the primary and alternate route become necessary, these points will be identified by the Telephone Company and provided to the ordering customer. Should the routing arrangement require special routing requirements specified by the customer, other rates and regulations as set forth in Section 9 or Section 10 may be applicable.

A customer may order the same or different type of DS3 SALs for each CDL(s) at which DS3 service is terminated.

Applies to All Exchanges Illinois

FACILITIES FOR INTRASTATE ACCESS

5. SPECIAL ACCESS (Cont'd)

5.6 Rate Regulations (Cont'd)

5.6.11 DS3 High Capacity Service (Cont'd)

(A) DS3 Rate Structure (Cont'd)

When a customer requests the disconnect of a DS3 service in the 3 System DS3 or Unlimited System DS3, an Additional System DS3 SAL must be disconnected first. When only the First DS3 service exists, that service will be disconnected.

Any costs associated with Special Construction as set forth in Section 10 will also apply.

DS3 Special Transport contains two rate elements, Special Transport Termination and Special Transport Facility. Special Transport Termination rates apply for the termination of each end of the interoffice facility. Special Transport Facility rates apply for each airline mile of the interoffice facility. Group System DS3* Transport Terminations (DS3 x 12 and DS3 x 24) and Group System DS3* Transport Facilities are only available when connected to at least one DS3 Group System* SAL of the same level (12 or 24). In addition, the Special Transport Facility and Special Transport Termination rates apply per DS3 Group as 12 or 24*.

(B) Minimum Service Periods

Individual DS3s and System DS3s are offered under four minimum service periods, each with different rate levels. The minimum service periods are 1, 3, 5 and 7 years. The customer must specify the minimum service period at the time the service is ordered. First and Additional DS3 SALs (3 System DS3s and Unlimited System DS3s) can have a different minimum service period. However, each DS3 SAL of a two-point DS3 service must have the same minimum service period.

*Limited to those services so equipped and in service as of March 25, 1999.

Applies to All Exchanges Illinois

FACILITIES FOR INTRASTATE ACCESS

5. SPECIAL ACCESS (Cont'd)

5.6 Rate Regulations (Cont'd)

5.6.11 DS3 High Capacity Service (Cont'd)

(B) Minimum Service Periods (Cont'd)

The customer may select a longer minimum service period at any time, without penalty or application of nonrecurring charges, to obtain the lower monthly recurring rates associated with a longer minimum service period. When the customer selects this option, no credit toward the new service period will be given for the amount of time they were under the shorter minimum service period. The new recurring charges will apply subsequent to the effective date of the new minimum service period.

(C) Expiration of Service Period

At the expiration of a service commitment period, the Customer may select a new DS3 commitment period. If the customer does not select a new minimum service period within 60 days from the expiration date, billing will remain at the current service period and a new DS3 minimum service period will begin based on the previously effective service period. All terms and conditions, including Subsequent Termination Liabilities will apply to the new DS3 period.

Customers with expired service periods for the Individual System, Three System and unlimited System DS3s, prior to the effective date of this tariff offering, will have up to 180 days to select a new commitment service period. If the Customer does not select a new service period within 180 days of the effective date of this tariff, billing will remain at the current service period and a new DS3 minimum service period will begin based on the last service period. The beginning date of the new service period will be the date immediately following the expiration date of the expired service period. This does not apply to the grandfathered DS3 Group System service offerings.

Applies to All Exchanges Illinois

FACILITIES FOR INTRASTATE ACCESS

5. SPECIAL ACCESS (Cont'd)5.6 Rate Regulations (Cont'd)5.6.11 DS3 High Capacity Service (Cont'd)(D) Discontinuance Without Liability - DS3 Minimum Service Period

Should the recurring charges for a customer's DS3 service increase, in aggregate, by more than 10% from the original recurring charges during the minimum service period, the customer may, at their option, terminate the DS3 service without penalty or liability.

(E) Discontinuance With Liability - DS3 Minimum Service Period

When a DS3 service is discontinued prior to the end of the minimum service period, the customer will be liable for a percentage of the total monthly charges for the remaining portion of the minimum service period. This charge will be based on the rates in effect at the time of disconnect. There are two liability periods for DS3 service, "first liability period" and "subsequent liability period." The "first liability period" is the period beginning from the establishment of the DS3 and is based on the customer's initial commitment term for the DS3. The "subsequent liability period" is the period after the customer's initial commitment term has expired and the customer wants to renew the DS3 service with the existing term period or select a new DS3 term period. The customer's total liability for the "first liability period" or "subsequent liability period" is dependent upon the number of months remaining within the year that the service is discontinued times the liability rate for that year plus the total monthly charges for each annual period remaining in the "first liability period" or "subsequent liability period" times the applicable liability rate. The liability rates for each year of the minimum service period are as follows:

<u>Year In Which Service Is Discontinued</u>		<u>1st Liability Period Rate</u>	<u>Subsequent Liability Period Rate</u>
1	45%	20%	
2	30%	20%	
3	25%	20%	
4	20%	20%	
5	20%	20%	
6	20%	20%	
7	20%	20%	

Applies to All Exchanges Illinois

FACILITIES FOR INTRASTATE ACCESS

5. SPECIAL ACCESS (Cont'd)5.6 Rate Regulations (Cont'd)5.6.11 DS3 High Capacity Service (Cont'd)(E) Discontinuance With Liability - DS3 Minimum Service Period (Cont'd)

For example, if a customer with a first liability period of seven years discontinues the DS3 service after six months within the 4th year, the customer will be liable for 20% of the total monthly charges for six months, 20% of the total monthly charges for the 6th year and 20% of the total monthly charges for the 7th year.

If the DS3 service is disconnected during the subsequent seven year liability period, the Customer will be liable for 20% of the total monthly charges for the remaining months for each annual period remaining in the seven year minimum service period.

Customers with a minimum service period arrangement of three years or greater established prior to September 17, 1992, who discontinue service are eligible for limitation of the termination liability as set forth below.

Customer liability will be calculated as previously stated but will be limited to:

The dollar difference between 1) the amount the customer has already paid and, 2) any additional charges that the customer would have paid for service if the customer had taken a shorter term offering corresponding to the term actually used.

For example, if a customer with a seven year minimum service period discontinues service after six months within the third year, the customer liability will not exceed:

[(Three year monthly rate - Seven year monthly rate) x 42 months]

Applies to All Exchanges Illinois

FACILITIES FOR INTRASTATE ACCESS

5. SPECIAL ACCESS (Cont'd)5.6 Rate Regulations (Cont'd)5.6.11 DS3 High Capacity Service (Cont'd)(F) Notification of Discontinuance

Notice of discontinuance must be given by the customer at least thirty days prior to actual discontinuance. Monthly charges will apply for a period of thirty days from the date the Company receives discontinuance notification or until the requested discontinuance date, whichever period is longer.

(G) Upgrade to Higher Speed Service

Customers may elect to upgrade DS3 service(s) to a higher speed during a first liability period or subsequent liability period. The upgraded service will be subject to all appropriate NRCs.

If the following conditions exist, no termination liabilities will be applied:

- Both the existing and the new services are provided solely by the Company.
- The order to discontinue a service at an existing speed or capacity and the order for the upgraded service are received by the Company at the same time.
- The new service will be provided at the same customer location(s) as the discontinued service.
- The fixed-period plan for the upgraded service(s) meets or exceeds the remaining length of the existing fixed-period plan.
- The total monthly rate of the new agreement is equal to or greater than the total monthly rate of the existing agreement period.
- The monthly rates for the upgraded services and/or service elements will be those in effect at the time of the service upgrade. The upgraded service will be subject to all appropriate nonrecurring charges.
- Termination liability charges will not apply as long as the upgraded service remains connected at the same point of termination(s) or meets the requirements set forth in Section 5.6.4(B)(2).

Applies to All Exchanges Illinois

FACILITIES FOR INTRASTATE ACCESS

5. SPECIAL ACCESS (Cont'd)

5.6 Rate Regulations (Cont'd)

5.6.11 DS3 High Capacity Service (Cont'd)

(H) DS3 Multiplexer Cross Connect Arrangement

For DS3 multiplexed services, the DS3 Multiplexer Cross Connect arrangement allows a customer to cross connect digital DS1 channels from one multiplexer to another multiplexer. The rate as specified in 5.7.15 will apply per cross connect arrangement. If the DS3 multiplexed services are located in different hub wire centers, DS1 special transport will apply in addition to the DS3 cross connect charge. The customer must provide the channel assignments (CFA and SCFA) for both multiplexed services on the ASR.

(I) Partitioned Billing Arrangement (PBA)

PBA is a service arrangement that allows System DS3 (3 System, Unlimited System, or Group System*) customers to partition the multiple DS3s to a number of CDLs on the other end of the circuit (see diagram below). All rate elements associated with the PBA must be billed to the same customer.

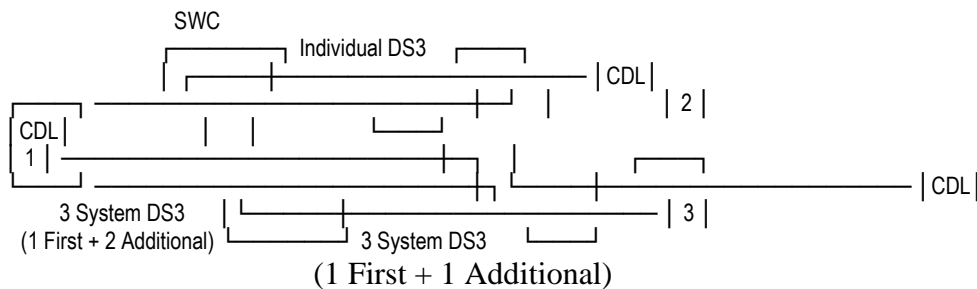

For 3 System DS3s and Unlimited System DS3s ordered under a PBA, each CDL must have a first system SAL. Additional SALs may then be ordered under the normal System terms and conditions.

Applies to All Exchanges Illinois

FACILITIES FOR INTRASTATE ACCESS

5. SPECIAL ACCESS (Cont'd)5.6 Rate Regulations (Cont'd)5.6.11 DS3 High Capacity Service (Cont'd)(I) Partitioned Billing Arrangement (PBA) (Cont'd)

When Group System DS3* Special Transport is provided as part of a PBA, a Group System DS3* SAL of the same level (DS3 x 12, DS3 x 24)* must be connected to one end of the Group DS3* Special Transport. Under a PBA only, DS3 x 12 Group System* Special Transport may be connected to DS3 x 24 Group System* Special Transport at hub wire centers. Also, standard DS3 Special Transport may be connected to either DS3 Group System* Special Transport at hub wire centers. All DS3 Special Transport Terminations apply for each type of DS3 Special Transport.

When ordering a PBA the customer must specify on the ASR the Access Service Group (ASG) and the First System DS3 circuit identification (ECCKT) at both CDLs. Each 3 System DS3 and/or Unlimited System DS3 at a CDL must be ordered as separate PBAs.

Customers with existing DS3 Systems (3 System, Unlimited System, or Group System*) may convert to a PBA. To convert, the customer must issue discontinuance of service ASR(s) for the existing DS3s and establishment of new service ASR(s) for each CDL to be converted to the PBA. If no physical changes to the service(s) are required, no NRCs will apply. If any physical changes are required, appropriate NRCs will apply.

*Limited to those services so equipped and in service as of March 4, 1999.

Applies to All Exchanges Illinois

FACILITIES FOR INTRASTATE ACCESS

5. SPECIAL ACCESS (Cont'd)

5.6 Rate Regulations (Cont'd)

5.6.12 Optional Payment Plan (OPP)

(A) General

- (1) The terms and conditions specified herein are applicable to FT1, FiberConnect and DDS services. Additional terms and conditions for FT1 OPP are set forth in 5.6.12(H). Additional terms and conditions for DDS OPP are set forth in 5.6.12(I).
- (2) Only the Special Access Line (SAL) rate element is available under an OPP. All other associated rate elements or additional features are available at the standard month-to-month tariffed rates and regulations.
- (3) FT1 OPP SAL rates will not be greater than standard month-to-month SAL rates. FiberConnect is not available on a month-to-month basis.
- (4) Three year and five year OPP rates will be equal to or less than the one year OPP rates. Decreases to the one year OPP will flow through to the three year and five year OPP.
- (5) Payment periods of one year, three year, and five year are available to all customers at the applicable rates set forth in 5.7.5(B), 5.7.8 or 5.7.9(B) regardless of when they subscribe to an OPP arrangement.
- (6) The customer must designate on the ASR the payment period for the OPP.
- (7) Inside moves, provided in accordance with 5.6.4, will not incur termination liability charges.
- (8) Outside moves provided in accordance with 5.6.4(B)(2) will allow the customer to retain the same OPP payment period. Any other move will be treated as a disconnect of the service and termination liability charges will apply.

Applies to All Exchanges Illinois

FACILITIES FOR INTRASTATE ACCESS

5. SPECIAL ACCESS (Cont'd)

5.6 Rate Regulations (Cont'd)

5.6.12 Optional Payment Plan (OPP) (Cont'd)

(B) Changes in Length of OPP Period

Prior to the completion of the selected OPP period, the customer may elect to convert to a new OPP period of the same or different length, subject to the following conditions:

- No credit toward the new payment period will be given for payments made under the original OPP arrangement.
- Nonrecurring charges will not be reapplied for existing service(s).
- If the new OPP period is shorter in length than the time remaining under the existing OPP, the change to the new OPP period constitutes a disconnect of the existing OPP service and termination liability charges apply.

(C) Renewal Options

- (1) At the expiration of an OPP period, the Telephone Company will automatically renew the service at the same OPP period unless the customer chooses to convert to a different OPP period, convert to month-to-month rates (except FiberConnect) or discontinue service.
- (2) Conversion to a different OPP period will require the customer to submit a change order ASR. Conversion to a different OPP period will be allowed without application of any nonrecurring or ordering charges.
- (3) Conversion to month-to-month rates will be treated as a disconnect of service and establishment of new service. If no other changes are ordered, no NRCs will apply.

Applies to All Exchanges Illinois

FACILITIES FOR INTRASTATE ACCESS

5. SPECIAL ACCESS (Cont'd)5.6 Rate Regulations (Cont'd)5.6.12 Optional Payment Plan (OPP) (Cont'd)(D) Notification of Discontinuance

An ASR for discontinuance of an OPP arrangement must be received by the Telephone Company at least thirty (30) days prior to actual disconnect of service. Monthly charges will apply for a period of thirty (30) days from the date the Telephone Company receives disconnect notification or until the requested disconnect date, whichever period is longer.

(E) Upgrade to Higher Speed Service

Customers may elect to upgrade service(s) to a higher speed during an OPP period, subject to the following conditions:

- The upgraded service will be subject to all appropriate nonrecurring charges.
- Termination liability charges will not apply as long as the upgraded service remains connected at the same point of termination(s) or meets the requirements set forth in 5.6.4(B)(2).
- If the upgrade involves establishing a multiplexing arrangement, termination liability charges will not apply if the hub wire center is the same one associated with the customer designated location.

Applies to All Exchanges Illinois

FACILITIES FOR INTRASTATE ACCESS

5. SPECIAL ACCESS (Cont'd)

5.6 Rate Regulations (Cont'd)

5.6.12 Optional Payment Plan (OPP) (Cont'd)

(F) Termination Liability

When an OPP service is discontinued prior to the end of the period, termination liability charges, as set forth below, will apply based on the remainder of the OPP period in effect at the time of disconnect.

One Year OPP - 50% of any remaining portion of the first year's recurring charges.

Three Year OPP - 50% of any remaining portion of the first year's recurring charges. In addition, for any remaining portion of the second and third years, the customer will be liable for 10% of the total monthly recurring charges in that time period.

Five Year OPP - 50% of any remaining portion of the first year's recurring charges. In addition, for any remaining portion of the second through fifth years, the customer will be liable for 20% of the total monthly recurring charges in that time period.

(G) Termination Without Liability

During an OPP period, should the currently effective rate for a customer's service increase, the customer may, at their option, terminate the OPP arrangement without penalty or liability.

Applies to All Exchanges Illinois

FACILITIES FOR INTRASTATE ACCESS

5. SPECIAL ACCESS (Cont'd)5.6 Rate Regulations (Cont'd)5.6.12 Optional Payment Plan (OPP) (Cont'd)(H) OPP for FT1 Service

A customer may change from DS1 OPP service to an FT1 OPP service subject to the following rate applications. Also, a customer may change the number of channels of an N x 56 Kbps or N x 64 Kbps service to another higher value of N (where N = 2, 4 or 6), subject to the following rate applications:

- The changed service will be subject to all appropriate nonrecurring charges.
- Termination liability charges will not apply as long as the changed service remains connected at the same point of termination(s) or meets the requirements of 5.6.4(B)(2).
- If the change involves establishing a multiplexing arrangement, termination liability charges will not apply if the hub wire center is the same one associated with the customer designated location.

(I) OPP for DDS

- (1) For conversion of existing month-to-month DDS to an OPP arrangement, the customer will be required to submit a change order ASR to convert to the OPP. No service or billing interruption will occur when a customer converts from month-to-month rates to OPP rates. If no other changes to be service are ordered, no charges will apply.
- (2) A customer may upgrade from a DDS OPP to an FT1 OPP subject to the following rate applications:
 - The changed service will be subject to all appropriate nonrecurring charges.
 - Termination liability charges will not apply as long as the changed service remains connected at the same point(s) of termination or meets the requirements of 5.6.4.

Applies to All Exchanges Illinois

FACILITIES FOR INTRASTATE ACCESS

5. SPECIAL ACCESS (Cont'd)

5.6 Rate Regulations (Cont'd)

5.6.13 Four-Wire Voiceband and Digital Data Service (DDS) Rate Stability Plan (RSP)

(A) Description

The Four-Wire Voiceband and DDS RSP will allow customers to stabilize their monthly recurring rates (MRCs) for Four-Wire Voiceband and DDS SALs and associated Voiceband and DDS Special Transport. This service is offered for a fixed service period at the rates specified in Section 5.7.16. The RSP allows customers to select a service commitment period during which the rates will be stabilized. The minimum and maximum service commitment periods are 3 years or 5 years, which must be specified in writing at the time of enrollment.

The RSP is available to customers qualifying for the Plan's eligibility requirements and agree to the Plan's terms and conditions.

Customers of the Plan will not be subject to Telephone Company initiated rate increases during their service commitment period. Rate changes may occur as a result of FCC or Commission Action.

Four-Wire Voiceband and DDS RSP rates will not be greater than standard month-to-month Four-Wire Voiceband and DDS SAL rates and associated Voiceband and DDS Special Transport rates.

Issued: May 10, 2011

Effective: July 1, 2011

By Kenneth Mason
Vice President
of Government and Regulatory Affairs

Applies to All Exchanges Illinois

FACILITIES FOR INTRASTATE ACCESS

5. SPECIAL ACCESS (Cont'd)

5.6 Rate Regulations (Cont'd)

5.6.13 Four-Wire Voiceband and Digital Data Service (DDS) Rate Stability Plan (RSP)
(Cont'd)

(B) Eligibility Requirement

The eligibility requirement for RSP is a minimum combined total of 500 Four-Wire Voiceband and DDS SALs. These SALs must be intrastate services and provided by the Company within the State of Illinois. Any associated Special Transport is also subject to the terms and conditions of the RSP.

At an annual review, if the customer has committed to more than the minimum number of 500 SALs required, an allowance of minus 2% or plus 5% will be considered as having met the commitment level.

When the customer elects to enroll in an RSP, he must specify, in writing, the enrollment date (which will be the anniversary date) and the commitment level. The specified enrollment date must be within 30 days of receipt by the Telephone Company. By the specified date, the customer must issue ASRs to add SALs to the RSP and/or convert month-to-month SALs to the RSP to fall within the commitment range specified above.

Besides the eligibility requirement, customers of this plan are also subject to the terms and conditions specified in Section 5.6.13(C).

(C) RSP Terms and Conditions

- (1) Written notice must be submitted by the customer to change the commitment level of SALs. If, as the result of increasing or decreasing the commitment level, service is changed from the RSP to a month-to-month arrangement or from a month-to-month arrangement to the RSP, an ASR will be required within 30 days for all services changed. Only one RSP will be allowed per customer. Penalties for decreasing the commitment level are discussed in 5.6.13(C)(4).

Applies to All Exchanges Illinois

FACILITIES FOR INTRASTATE ACCESS

5. SPECIAL ACCESS (Cont'd)

5.6 Rate Regulations (Cont'd)

5.6.13 Four-Wire Voiceband and Digital Data Service (DDS) Rate Stability Plan (RSP)
(Cont'd)

(C) RSP Terms and Conditions

- (2) Each customer's RSP will be reviewed annually. The customer will be notified in writing as to the status of the RSP. This notification will inform the customer of any RSP SALs that must be converted. If the customer has increased the number of SALs from the initial commitment beyond the range specified in 5.6.13(B), he will have the option of increasing the commitment level for the remainder of the plan. If the customer chooses not to increase the commitment level of SALs for the remaining year(s) of the plan, he must convert the increased number of SALs to standard month-to-month SALs to a level within the range specified in 5.6.13(B). The customer may decrease the commitment level at the time of the annual review and pay the applicable penalties for the amount of SALs being decreased. The customer will have 30 days from the receipt of this notification to convert SALs.
- (3) If a service has two SALs, to include this service as part of the RSP, both SALs must be in the RSP. RSP rates for Special Transport are only applicable when the associated SALs are included in the RSP.

After enrolling in the plan, the customer may add or delete RSP SALs at any time during the plan.

- (4) When the number of RSP SALs at the annual review is less than the acceptable commitment range, penalty charges will apply, based on the difference between the commitment level less 2% and the number of RSP SALs in effect at the annual review. For example, if the commitment level is 100 and the customer has 90 RSP SALs at the time of the annual review, the penalties described below will be applied to the difference of 98 (2% less than 100) and 90, which would be 8 in this example.

Applies to All Exchanges Illinois

FACILITIES FOR INTRASTATE ACCESS

5. SPECIAL ACCESS (Cont'd)5.6 Rate Regulations (Cont'd)5.6.13 Four-Wire Voiceband and Digital Data Service (DDS) Rate Stability Plan (RSP)
(Cont'd)(C) RSP Terms and Conditions (Cont'd)

(4) (Cont'd)

The penalty charged is equal to the unweighted average of the customer's applicable RSP Four-Wire Voiceband SAL and DDS SAL monthly rates multiplied by the deficient number of SALs.

Example:

RSP rates for the customer's Four-Wire Voiceband and DDS services are as follows:

<u>Type SAL</u>	<u>Effective RSP Rate</u>
Four-Wire Voiceband	\$ 28.15
DDS (2.4, 4.8, 9.6, 19.2 Kbps)	52.25
DDS (56, 64 Kbps)	<u>64.60</u>
Totals	\$145.00

UNWEIGHTED AVERAGE OF RSP RATES: $\$145.00/3 = \48.33

Review of the customer's records reveals a growth requirement deficiency of eight SALs. The applicable penalty charged would be $\$48.33 \times 8 = \386.64 .

(D) RSP Nonrecurring Charge

No nonrecurring charge will apply for the ASRs processed to convert existing SALs to or from the RSP. All applicable Special Access NRCs will apply for ASRs processed to add new SALs. Refer to Section 5.7.2 for Voiceband SAL NRCs and Section 5.7.5 for Digital Data Service SAL NRCs.

Applies to All Exchanges Illinois

FACILITIES FOR INTRASTATE ACCESS

5. SPECIAL ACCESS (Cont'd)

5.6 Rate Regulations (Cont'd)

5.6.13 Four-Wire Voiceband and Digital Data Service (DDS) Rate Stability Plan (RSP)
(Cont'd)

(E) RSP Services

This Plan is offered only for Four-Wire Voiceband and Digital Data Service (DDS).

(F) RSP Application

(1) Rate Elements Subject to the Plan

The RSP stabilizes the MRCs for Four-Wire Voiceband SALs, DDS SALs, and their associated Voiceband and DDS Special Transport MRCs. The MRCs for these rate elements will not be increased by initiation of the Telephone Company from the rates in effect as of the RSP enrollment date for the duration of the service commitment period. The RSP enrollment date is the date on which the RSP customer signs a written agreement for RSP and otherwise meets the Plan's eligibility requirements.

All RSP customers will pay the same RSP rate at any given point in time. However, each RSP customer will have only one RSP enrollment date, which will apply to all of the customer's rate elements subject to the Plan. This is regardless of whether services were existing and converted to the RSP, added at the time of enrollment, or added subsequently during the RSP service commitment period.

Applies to All Exchanges Illinois

FACILITIES FOR INTRASTATE ACCESS

5. SPECIAL ACCESS (Cont'd)

5.6 Rate Regulations (Cont'd)

5.6.13 Four-Wire Voiceband and Digital Data Service (DDS) Rate Stability Plan (RSP)
(Cont'd)

(F) RSP Application

(1) Rate Elements Subject to the Plan

Before the expiration of a customer's RSP service commitment period, the RSP may be replaced by a new RSP at the tariffed rates currently in effect. The customer will not incur any penalties associated with their current plan if the elected service period is equal to or greater than the time remaining on the current RSP. For any new services added to the Plan, the MRCs will be at the rate in effect when the customer elects the new plan. However, billing for these services will not begin until the services have been installed.

The RSP does not apply to NRCs associated with Four-Wire Voiceband and DDS, supplemental features and multiplexing arrangements.

(2) RSP Expiration

At the end of the service commitment period, the customer may either continue the services at non-RSP rates in effect or elect a new RSP. If the customer chooses to convert to a new RSP, the new service period will begin the day following the expiration of the old Plan. The RSP rate for the new Plan will be at those in effect at the beginning of the new service period. If the customer fails to make this selection, the Telephone Company will notify the customer and continue one additional month of RSP billing. If the customer does not notify the Company of its intentions within 30 days from the expiration date of the RSP, the services under the plan will revert to general tariffed rates.

Issued: May 10, 2011

Effective: July 1, 2011

By Kenneth Mason
Vice President
of Government and Regulatory Affairs

Applies to All Exchanges Illinois

 FACILITIES FOR INTRASTATE ACCESS

5. SPECIAL ACCESS (Cont'd)5.6 Rate Regulations (Cont'd)5.6.13 Four-Wire Voiceband and Digital Data Service (DDS) Rate Stability Plan (RSP)
(Cont'd)(F) RSP Application (Cont'd)(3) Upgrade to Higher Capacity Service

The customer may upgrade service to a high capacity service during the RSP period. The upgraded service will be subject to all appropriate NRCs.

If both of the following conditions exist, the commitment level will be decreased by the number of RSP SALs that are upgraded to a high capacity service.

- The customer must notify the Telephone Company in writing in addition to issuing an ASR.
- The high capacity service period must be equal to or longer in length than the time remaining under the RSP.

5.6.14 DS1 Term Volume Plan (TVP) #

(T)

(A) Description

The DS1 Term Volume Plan (TVP) allows customers discounts, which are applied to DS1 SALs based upon a volume and term commitment. The customer's DS1 SAL commitment level can be establishment on a statewide basis or negotiated between the customer and the Telephone Company. The TVP is offered for a 1, 2, 3, or 5 year service commitment period. All of the customer's TVP DS1 SALs will be billed the same rate based on the length of the term selected by the customer and the threshold level in which the commitment quantity falls. All other associated rate elements or additional features are available at the standard month-to-month tariffed rates and regulations.

 # Services are only available to current service subscribers as of 9/23/13 at their current locations.

Issued: August 8, 2013

Effective: September 23, 2013

(N)

By Kenneth Mason
Vice President
of Government and Regulatory Affairs

Applies to All Exchanges Illinois

FACILITIES FOR INTRASTATE ACCESS

5. SPECIAL ACCESS (Cont'd)5.6 Rate Regulations (Cont'd)5.6.14 DS1 Term Volume Plan (TVP) # (Cont'd)

(T)

(A) Description (Cont'd)

During the TVP term, the customer may elect to increase the term or commitment level of the plan without any Termination Liability provided there is no lapse of time between the effective date of the increase and the termination of the previously effective term or commitment quantity.

The new term length begins on the same start day as the term length it replaces. There will not be any retroactive adjustments of a discount due to a customer-initiated change in term or commitment quantity.

(B) Rate Application

For conversion of existing month-to-month DS1 service to a TVP arrangement, the customer will be required to submit written notification or a change order ASR to convert to the TVP. No service or billing interruption will occur when a customer converts from month-to-month rates to a TVP. If no other changes to the service(s) are ordered, no charges will apply.

If a change involved establishing a multiplexing arrangement, termination liability will not apply if the hub wire center and the serving wire center of the customer designation location are the same.

(C) Rate Changes

Rate changes in the TVP monthly recurring DS1 SAL rates will be passed on to subscribers of the plan. However, during the TVP period, should the rates increase, the customer may, at his option, terminate the TVP arrangement without penalty or liability, unless the increase is a result of FCC action.

(D) Threshold Levels

Two or more DS1 SALs are required to qualify for a TVP. Rates are applied based on the following DS1 SAL threshold levers: 2-60, 61-120, 121-500, 501-1000, 1001-3000, 3001-6000, 6001-11,000 and over 11,000.

Services are only available to current service subscribers as of 9/23/13 at their current locations.

(N)

Issued: August 8, 2013

Effective: September 23, 2013

By Kenneth Mason
Vice President
of Government and Regulatory Affairs

Applies to All Exchanges Illinois

 FACILITIES FOR INTRASTATE ACCESS

5. SPECIAL ACCESS (Cont'd)

5.6 Rate Regulations (Cont'd)

5.6.14 DS1 Term Volume Plan (TVP) # (Cont'd)

(T)

(E) Changes to Commitment Quantity or Term

At any time during the plan term, the customer may increase the commitment quantity of DS1 SALs or commitment term to receive a lower threshold rate by submitting written notification to the Telephone Company.

When a penalty is assessed at the annual review, as set forth in 5.6.14, the number of DS1 SALs in service will become the commitment quantity for the subsequent years' annual review.

(F) TVP Plan Enrollment*

When the customer elects to enroll in a TVP, he must specify, in writing, enrollment date (which will be the anniversary date) and the DS1 SAL commitment quantity. The specified enrollment date must be within 30 days of receipt. By the specified date, the customer must submit a request in writing or issue ASR(s) to add DS1 SALs to the TVP and/or convert month-to-month arrangement DS1 SALs to the TVP to fall within the commitment quantity specified.

(G) Annual Review

Each customer's TVP will be reviewed annually. The customer will be notified in writing as to the status of the TVP. If the in-service DS1 SAL quantity falls below the commitment quantity. An allowance of 3% will be considered as having met the commitment quantity. Where the customer does not meet the minimum quantity of DS1 SALs in service, penalties will be assessed as set forth under 5.6.14.

*On the effective date of this tariff offering, the TVP Service offering replaces the DS1 Term Payment Plan (TPP) and Optional Payment Plan (OPP) arrangements. Existing customers of these DS1 payment plans may be converted to the TVP based on their current term and quantity of DS1 SALs under the TPP or OPP, unless the customer designates a different arrangement. Customers will have 90 days to designate, in writing, a different TVP commitment quantity or term or select the month-to-month rate application. Termination liability charges will not apply. Customer's DS1 SALs not enrolled in their TVP will be rated as month-to-month.

Services are only available to current service subscribers as of 9/23/13 at their current locations.

(N)

Issued: August 8, 2013

Effective: September 23, 2013

By Kenneth Mason
 Vice President
 of Government and Regulatory Affairs

Applies to All Exchanges Illinois

FACILITIES FOR INTRASTATE ACCESS

5. SPECIAL ACCESS (Cont'd)

5.6 Rate Regulations (Cont'd)

5.6.14 DS1 Term Volume Plan (TVP) # (Cont'd)

(T)

(G) Annual Review (Cont'd)

If the number of DS1 SALs increase from the initial commitment, the customer will have the option of increasing the commitment level for the remainder of his TVP. If the customer chooses not to increase the commitment level, he may convert the increased number of DS1 SALs to a monthly plan or a second TVP plan.

The customer may decrease the commitment level at the time of the annual review and pay the applicable penalties for the amount of DS1 SALs being decreased. Penalties will apply as set forth in 5.6.14.

The customer will have 30 days from receipt of notification to convert DS1 SALs. If the customer does not take action during the 30 day period, the commitment level will be automatically changed to the number of TVP DS1 SALs in effect at the annual review.

(H) TVP Conditions

If a DS1 service (circuit) consists of two DS1 SALs, both DS1 SALs must be in the TVP.

After enrolling in the plan, the customer may add or delete DS1 SALs rated at the specified term/threshold level rate at any time during the plan. For example, if the customer agrees to a 2 year TVP at the 61-120 DS1 SAL threshold level, DS1 SALs may be added at any time at the 2 year 61-120 threshold rate level.

Services are only available to current service subscribers as of 9/23/13 at their current locations.

(N)

Applies to All Exchanges Illinois

 FACILITIES FOR INTRASTATE ACCESS

5. SPECIAL ACCESS (Cont'd)5.6 Rate Regulations (Cont'd)5.6.14 DS1 Term Volume Plan (TVP) # (Cont'd)

(T)

(I) Penalties for Failing to Meet Commitment

When the number of TVP DS1 SALs at the annual review is less than the commitment quantity minus 3%, the penalty will be the TVP rate for the current threshold multiplied by the shortfall multiplied by 4 months.

For example, if the commitment quantity is 100 and the customer has 90 DS1 TVP SALs at the time of the annual review, the penalty described below will be applied to the shortfall difference of 97 (3% less than 100) and 90.

- Current threshold level is 61-120, 5 year term
- In-service quantity at annual review is 90
- Shortfall is $97 - 90 = 7$
- Penalty is calculated as follows:
 $\$170.00^* \times 7 \times 4 \text{ months} = \4760.00 penalty.
 $^* \text{TVP MRC for five year, 61-120 quantity.}$

(J) TVP Nonrecurring Charge

Customers subscribing to a TVP will be assessed a nonrecurring charge per DS1 SAL except when converting standard month-to-month DS1 SALs to a TVP.

(K) Changes in Length of a TVP Period

Prior to the expiration of a TVP period, the customer may elect to convert to a new TVP period of the same or different length, subject to the following conditions:

- No credit will be given for the new payment period for payments made under the original TVP arrangement
- NRCs will not be reapplied for existing service(s)
- If the new TVP period is shorter in length than the time remaining under the existing TVP, the change to the new TVP period constitutes a disconnect of the existing TVP service and termination liability charges will apply as set forth under 5.6.14(N).

Services are only available to current service subscribers as of 9/23/13 at their current locations.

Issued: August 8, 2013

Effective: September 23, 2013

(N)

By Kenneth Mason
 Vice President
 of Government and Regulatory Affairs

Applies to All Exchanges Illinois

FACILITIES FOR INTRASTATE ACCESS

5. SPECIAL ACCESS (Cont'd)5.6 Rate Regulations (Cont'd)5.6.14 DS1 Term Volume Plan (TVP) # (Cont'd)

(T)

(L) Renewal Options

At the expiration of a TVP period, the customer may select a new TVP period or convert to a month to month payment plan. If the customer fails to make this selection, the Telephone Company will notify the customer and continue two additional months of TVP billing. If the customer does not select a new payment plan within 60 days from the expiration date, billing will remain at the current threshold level and a new TVP period will begin based on the previously effective term and quantity commitment. All terms and conditions, including termination liabilities, will apply to the new TVP period.

(M) Upgrade to Higher Speed Service

The customer may upgrade service to a higher speed during a TVP period. The upgraded service will be subject to all appropriate NRCs.

If the following conditions exist, no termination liabilities will be applied for the decreased number of TVP SALs that are upgraded to a higher speed service.

- The customer must notify Frontier in writing in addition to the ASR.
- The higher speed service period must be equal to or longer in length than the time remaining under the TVP.
- The upgraded service remains connected at the same point(s) of termination.

(N) Termination Liability

When a TVP arrangement is discontinued prior to the end of the commitment period, termination liability charges, as set forth below, will apply based on the remainder of the TVP period in effect at the time of disconnect.

Services are only available to current service subscribers as of 9/23/13 at their current locations
Issued: August 8, 2013 Effective: September 23, 2013

(N)

By Kenneth Mason
Vice President
of Government and Regulatory Affairs

Applies to All Exchanges Illinois

FACILITIES FOR INTRASTATE ACCESS**5. SPECIAL ACCESS (Cont'd)****5.6 Rate Regulations (Cont'd)****5.6.14 DS1 Term Volume Plan (TVP) # (Cont'd)**

(T)

(N) Termination Liability (Cont'd)

One year TVP - 50% of any remaining portion of the first year's recurring charges.

Two Year TVP - 50% of any remaining portion of the first year's recurring charges. In addition, for any remaining portion of the second year, the customer will be liable for 5% of the total monthly recurring charges in that time period.

Three Year TVP - 50% of any remaining portion of the first year's recurring charges. In addition, for any remaining portion of the second and third years, the customer will be liable for 10% of the total monthly recurring charges in that time period.

Five Year TVP - 50% of any remaining portion of the first year's recurring charges. In addition, for any remaining portion of the second through fifth years, the customer will be liable for 15% of the total monthly recurring charges in that time period.

(O) Termination Without Liability

During a TVP period, should the currently effective rate for a customer's service increase, the customer may, at their option, terminate the TVP arrangement without penalty or liability, unless the increase is the result of FCC action.

Services are only available to current service subscribers as of 9/23/13 at their current locations.

(N)

Applies to All Exchanges Illinois

FACILITIES FOR INTRASTATE ACCESS

5. SPECIAL ACCESS (Cont'd)5.7 Rates and Charges

	<u>Nonrecurring Charge</u>	<u>Monthly Rate</u>
5.7.1 <u>Nonrecurring Charges</u>		
<u>Design Change Charge</u> <u>Per ASR, Per Occurrence</u>	\$150.00	
5.7.2 <u>Voiceband Facilities</u>		
(A) <u>Standard Arrangements</u>		
Special Transport - Per Airline Mile		
Price Band A		\$ 2.85
Price Band B		2.85
Price Band C		2.85
N-MSA		2.85
Special Access Line Nonrecurring Charge		
Price Band A	\$200.00	
Price Band B	200.00	
Price Band C	200.00	
N-MSA	200.00	
Two-Wire		
Price Band A		24.75
Price Band B		24.75
Price Band C		24.75
N-MSA		26.75
Four-Wire		
Price Band A		32.85
Price Band B		32.85
Price Band C		32.85
N-MSA		35.50

Note: N-MSA rates apply to Special Access Lines terminating at end user locations.

Issued: May 10, 2011

Effective: July 1, 2011

By Kenneth Mason
Vice President
of Government and Regulatory Affairs

Applies to All Exchanges Illinois

FACILITIES FOR INTRASTATE ACCESS

5. SPECIAL ACCESS (Cont'd)5.7 Rates and Charges (Cont'd)

	<u>Nonrecurring Charge</u>	<u>Monthly Rate</u>
5.7.2 <u>Voiceband Facilities</u> (Cont'd)		
(B) <u>Optional Arrangements Supplemental Features</u>		
Multi-point Data Bridging Per Port	-	\$ 8.00
Voice Conference Bridging Per Port	-	8.00
Alarm Distribution Bridging Common Equipment		
Price Band A	-	30.00
Price Band B	-	30.00
Price Band C	-	30.00
N-MSA	-	30.00
Per Two-Wire Port		
Price Band A	-	2.00
Price Band B	-	2.00
Price Band C	-	2.00
N-MSA	-	2.00

Issued: May 10, 2011

Effective: July 1, 2011

By Kenneth Mason
Vice President
of Government and Regulatory Affairs

Applies to All Exchanges Illinois

FACILITIES FOR INTRASTATE ACCESS

5. SPECIAL ACCESS (Cont'd)5.7 Rates and Charges (Cont'd)

	<u>Nonrecurring Charge</u>	<u>Monthly Rate</u>
--	--------------------------------	-------------------------

5.7.2 Voiceband Facilities (Cont'd)(B) Optional Arrangements (Cont'd)
Supplemental Features (Cont'd)

Conditioning Arrangements – Data

Type C		
MSA	-	\$ 1.50
N-MSA	-	1.50
Type DA		
MSA	-	2.00
N-MSA	-	2.00
Type C-Improved		
MSA	-	30.00
N-MSA	-	30.00
Signaling Arrangements, Per SAL		
Loop Signaling Range Extension		
MSA	-	10.00
N-MSA	-	10.00
Loop or E&M to SF		
MSA	-	16.00
N-MSA	-	16.00

Applies to All Exchanges Illinois

FACILITIES FOR INTRASTATE ACCESS

5. SPECIAL ACCESS (Cont'd)5.7 Rates and Charges (Cont'd)

	<u>Nonrecurring Charge</u>	<u>Monthly Rate</u>
--	--------------------------------	-------------------------

5.7.2 Voiceband Facilities (Cont'd)(B) Optional Arrangements (Cont'd)
Supplemental Features (Cont'd)

Signaling Arrangements, Per SAL (Cont'd)

E&M to DX		
MSA	-	\$ 14.00
N-MSA	-	14.00
E&M to Loop		
MSA	-	12.00
N-MSA	-	12.00
Loop or E&M to PCM		
MSA	-	4.00
N-MSA	-	4.00
Automatic Ringdown		
MSA	-	10.00
N-MSA	-	10.00

Applies to All Exchanges Illinois

FACILITIES FOR INTRASTATE ACCESS

5. SPECIAL ACCESS (Cont'd)5.7 Rates and Charges (Cont'd)

	<u>Nonrecurring Charge</u>	<u>Monthly Rate</u>
5.7.2 <u>Voiceband Facilities</u> (Cont'd)		
(B) <u>Optional Arrangements</u> (Cont'd)		
<u>Supplemental Features</u> (Cont'd)		
Echo Control, per circuit		
Echo Suppression*		
MSA	-	\$ 30.00
N-MSA	-	30.00
Echo Cancellor		
MSA	-	85.00
N-MSA	-	85.00
Voiceband Facility Switching		
Arrangement		
MSA	-	7.00
N-MSA	-	7.00
Improved Return Loss, Per SAL		
MSA	-	3.75
N-MSA	-	3.75
Improved Termination Option, Per SAL		
MSA	-	10.00
N-MSA	-	10.00
Improved Equal Level Echo Path Loss, Per SAL		
MSA	-	3.75
N-MSA	-	3.75

* Obsolete and is applicable only to circuits so equipped prior to January 1, 1987.

Issued: May 10, 2011

Effective: July 1, 2011

By Kenneth Mason
Vice President
of Government and Regulatory Affairs

Applies to All Exchanges Illinois

FACILITIES FOR INTRASTATE ACCESS

5. SPECIAL ACCESS (Cont'd)5.7 Rates and Charges (Cont'd)5.7.3 Program Audio Facilities

	<u>Nonrecur Charge</u>	<u>Monthly Rate</u>	<u>Daily Rate</u>
(A) <u>Standard Arrangements - (200 - 3500 Hz)</u>			
Special Transport - Per Airline Mile			
Price Band A	\$ 6.37		\$.64
Price Band B	6.37		.64
Price Band C	6.37		.64
N-MSA	7.39		1.77
Special Access Line			
Price Band A	\$200.00	22.33	2.23
Price Band B	200.00	22.33	2.23
Price Band C	200.00	22.33	2.23
N-MSA	200.00	26.80	2.68
(B) <u>Standard Arrangements - (100 - 5000 Hz)</u>			
Special Transport - Per Airline Mile			
Price Band A	6.37		.64
Price Band B	6.37		.64
Price Band C	6.37		.64
N-MSA	7.39		.77
Special Access Line			
Price Band A	200.00	22.33	2.23
Price Band B	200.00	22.33	2.23
Price Band C	200.00	22.33	2.23
N-MSA	200.00	26.80	2.68

Note: N-MSA rates apply to Special Access Lines terminating at end user locations.

Issued: May 10, 2011

Effective: July 1, 2011

By Kenneth Mason
Vice President
of Government and Regulatory Affairs

Applies to All Exchanges Illinois

FACILITIES FOR INTRASTATE ACCESS

5. SPECIAL ACCESS (Cont'd)5.7 Rates and Charges (Cont'd)5.7.3 Program Audio Facilities (Cont'd)

	Nonrecurring Daily <u>Charge</u>	<u>Rate</u>	Monthly <u>Rate</u>
(C) <u>Standard Arrangements (50 - 8000 Hz)</u>			
Special Transport - Per Airline Mile			
Price Band A		6.37	.64
Price Band B		6.37	.64
Price Band C		6.37	.64
N-MSA		7.39	.77
Special Access Line			
Price Band A	200.00	22.33	2.23
Price Band B	200.00	22.33	2.23
Price Band C	200.00	22.33	2.23
N-MSA	200.00	26.80	2.68

Note: N-MSA rates apply to Special Access Lines terminating at end user locations.

Issued: May 10, 2011

Effective: July 1, 2011

By Kenneth Mason
Vice President
of Government and Regulatory Affairs

Applies to All Exchanges Illinois

FACILITIES FOR INTRASTATE ACCESS

5. SPECIAL ACCESS (Cont'd)5.7 Rates and Charges (Cont'd)5.7.3 Program Audio Facilities (Cont'd)

	<u>Nonrecurring Charge</u>	<u>Monthly Rate</u>	<u>Daily Rate</u>
(D) <u>Standard Arrangements (50 - 15000 Hz)</u>			
Special Transport - Per Airline Mile			
Price Band A		\$ 6.37	\$.64
Price Band B		6.37	.64
Price Band C		6.37	.64
N-MSA		7.39	.77
Special Access Line			
Price Band A	\$ 200.00	22.33	2.23
Price Band B	200.00	22.33	2.23
Price Band C	200.00	22.33	2.23
N-MSA	200.00	26.80	2.68
(E) <u>Optional Arrangements</u> <u>(50-15000 Hz Facilities Only)</u> <u>Supplemental Features</u>			
Conditioning-Program Audio Stereo			
Conditioning, Per Occurrence			
MSA	-	1.00	.10
N-MSA	-	1.00	.10

Note: N-MSA rates apply to Special Access Lines terminating at end user locations.

Applies to All Exchanges Illinois

FACILITIES FOR INTRASTATE ACCESS

5. SPECIAL ACCESS (Cont'd)5.7 Rates and Charges (Cont'd)5.7.3 Program Audio Facilities (Cont'd)

	<u>Nonrecurring Charge</u>	<u>Monthly Rate</u>	<u>Daily Rate</u>
(F) <u>Optional Arrangements</u> <u>(All Bandwidths)</u> <u>Supplemental Features</u>			
Program Audio Bridging, Per Port			
MSA	-	1.00	.10
N-MSA	-	1.00	.10
Conditioning-Program Audio, Zero Loss, Per SAL			
MSA	-	12.00	1.20
N-MSA	-	12.00	1.20

Note: N-MSA rates apply to Special Access Lines terminating at end user locations.

Issued: May 10, 2011

Effective: July 1, 2011

By Kenneth Mason
Vice President
of Government and Regulatory Affairs

Applies to All Exchanges Illinois

 FACILITIES FOR INTRASTATE ACCESS
5. SPECIAL ACCESS (Cont'd)5.7 Rates and Charges (Cont'd)5.7.4 Video Facilities

	<u>Nonrecurring Charge</u>	<u>Hourly Rate</u>
(A) <u>Temporary Videoband Service - Type I</u>		
<u>Permanent Facilities, Per Hop</u>	ICB	*
<u>Nonpermanent Facilities, Per Hop</u>	ICB	**
<u>Technician Standby, Per Hour</u>		**

* Provisioned as set forth in accordance with Special Construction in Section 10.

** Provisioned as set forth in accordance with Special Access ICBs in Section 5.

 Issued: May 10, 2011

Effective: July 1, 2011

By Kenneth Mason
Vice President
of Government and Regulatory Affairs

Applies to All Exchanges Illinois

FACILITIES FOR INTRASTATE ACCESS

5. SPECIAL ACCESS (Cont'd)5.7 Rates and Charges (Cont'd)

	<u>Nonrecurring Charge</u>	<u>Monthly Rate</u>
<u>5.7.5 Digital Data Service Facilities</u> <u>(2.4, 4.8, 9.6, 19.2, 56, and 64 Kbps)</u>		
<u>(A) Standard Arrangements</u>		
Special Transport - All Speeds		
Per Airline Mile		
Price Band A		\$ 3.55
Price Band B		3.55
Price Band C		3.55
N-MSA		5.05
Special Access Line		
Nonrecurring Charge, All Speeds		
Price Band A	\$ 250.00	
Price Band B	250.00	
Price Band C	250.00	
N-MSA	250.00	
2.4 kbps		
Price Band A		79.65
Price Band B		79.65
Price Band C		79.65
N-MSA		136.06
4.8 kbps		
Price Band A		79.65
Price Band B		79.65
Price Band C		79.65
N-MSA		136.06

Note: N-MSA rates apply to Special Access Lines terminating at end user locations.

Issued: May 10, 2011

Effective: July 1, 2011

By Kenneth Mason
Vice President
of Government and Regulatory Affairs

Applies to All Exchanges Illinois

FACILITIES FOR INTRASTATE ACCESS

5. SPECIAL ACCESS (Cont'd)5.7 Rates and Charges (Cont'd)

	<u>Nonrecurring Charge</u>	<u>Monthly Rate</u>
5.7.5 <u>Digital Data Service Facilities</u> <u>(2.4, 4.8, 9.6, 19.2, 56, and 64 Kbps)</u> (Cont'd)		
(A) <u>Standard Arrangements</u> (Cont'd)		
9.6 kbps		
Price Band A		79.65
Price Band B		79.65
Price Band C		79.65
N-MSA		136.06

Note: N-MSA rates apply to Special Access Lines terminating at end user locations.

Applies to All Exchanges Illinois

FACILITIES FOR INTRASTATE ACCESS

5. SPECIAL ACCESS (Cont'd)5.7 Rates and Charges (Cont'd)

	<u>Nonrecurring Charge</u>	<u>Monthly Rate</u>
<u>5.7.5 Digital Data Service Facilities</u>		
<u>(2.4, 4.8, 9.6, 19.2, 56, and 64 Kbps) (Cont'd)</u>		
<u>(A) Standard Arrangements (Cont'd)</u>		
19.2 kbps		
Price Band A		\$ 79.65
Price Band B		79.65
Price Band C		79.65
N-MSA		136.06
56 kbps		
Price Band A		79.65
Price Band B		79.65
Price Band C		79.65
N-MSA		136.06
64 kbps		
Price Band A		79.65
Price Band B		79.65
Price Band C		79.65
N-MSA		136.06

Note: N-MSA rates apply to Special Access Lines terminating at end user locations.

Applies to All Exchanges Illinois

FACILITIES FOR INTRASTATE ACCESS

5. SPECIAL ACCESS (Cont'd)5.7 Rates and Charges (Cont'd)

	<u>Nonrecurring Charge</u>	<u>Monthly Rate</u>
<u>5.7.5 Digital Data Service Facilities</u> <u>(2.4, 4.8, 9.6, 19.2, 56, and 64 Kbps)</u> (Cont'd)		
(B) <u>DDS Optional Payment Plan</u>		
Special Access Line		
Nonrecurring Charge, All Speeds		
Price Band A	\$ 0.00	
Price Band B	0.00	
Price Band C	0.00	
N-MSA	0.00	
2.4, 4.8, 9.6, 19.2 kbps		
1 Year		
Price Band A		\$ 65.00
Price Band B		65.00
Price Band C		65.00
N-MSA		81.59
3 Year		
Price Band A		55.00
Price Band B		55.00
Price Band C		55.00
N-MSA		69.04
5 Year		
Price Band A		54.50
Price Band B		54.50
Price Band C		54.50
N-MSA		68.41

Note: N-MSA rates apply to Special Access Lines terminating at end user locations.

Issued: May 10, 2011

Effective: July 1, 2011

By Kenneth Mason
Vice President
of Government and Regulatory Affairs

Applies to All Exchanges Illinois

FACILITIES FOR INTRASTATE ACCESS

5. SPECIAL ACCESS (Cont'd)5.7 Rates and Charges (Cont'd)

	<u>Nonrecurring Charge</u>	<u>Monthly Rate</u>
5.7.5 <u>Digital Data Service Facilities</u> (2.4, 4.8, 9.6, 19.2, 56, and 64 Kbps) (Cont'd)		
(B) <u>DDS Optional Payment Plan</u> (Cont'd)		
56, 64 kbps		
1 Year		
Price Band A		\$ 78.00
Price Band B		78.00
Price Band C		78.00
N-MSA		97.91
3 Year		
Price Band A		68.00
Price Band B		68.00
Price Band C		68.00
N-MSA		85.35
5 Year		
Price Band A		66.20
Price Band B		66.20
Price Band C		66.20
N-MSA		83.09
(C) <u>Optional Arrangements</u> <u>Supplemental Features</u>		
DDS Bridging, Per Port		
MSA	-	11.00
N-MSA	-	11.00

Note: N-MSA rates apply to Special Access Lines terminating at end user locations.

Applies to All Exchanges Illinois

FACILITIES FOR INTRASTATE ACCESS

5. SPECIAL ACCESS (Cont'd)5.7 Rates and Charges (Cont'd)

	<u>Nonrecurring Charge</u>	<u>Monthly Rate</u>
5.7.6 <u>Multiplexing Arrangements</u>		
DS1 to Voice		
Price Band A	\$ 800.00	\$ 195.00
Price Band B	800.00	195.00
Price Band C	800.00	195.00
N-MSA	800.00	201.83
DS3 to DS1		
Price Band A	450.00	341.90
Price Band B	450.00	341.90
Price Band C	450.00	341.90
N-MSA	450.00	336.38
Digital Data Carrier Multiplexer		
Price Band A	1,500.00	275.00
Price Band B	1,500.00	275.00
Price Band C	1,500.00	275.00
N-MSA	1,500.00	284.63
Digital Data Subrate Multiplexer		
One DSO Port to Twenty 2.4 kbps		
Price Band A	800.00	160.00
Price Band B	800.00	160.00
Price Band C	800.00	160.00
N-MSA	800.00	160.00
One DSO Port to Ten 4.8 kbps		
Price Band A	800.00	120.00
Price Band B	800.00	120.00
Price Band C	800.00	120.00
N-MSA	800.00	120.00

Note: N-MSA rates apply to Special Access Lines terminating at end user locations.

Applies to All Exchanges Illinois

FACILITIES FOR INTRASTATE ACCESS

5. SPECIAL ACCESS (Cont'd)5.7 Rates and Charges (Cont'd)

	<u>Nonrecurring Charge</u>	<u>Monthly Rate</u>
5.7.6 <u>Multiplexing Arrangements</u> (Cont'd)		
One DSO Port to Five 9.6 kbps		
Price Band A	800.00	100.00
Price Band B	800.00	100.00
Price Band C	800.00	100.00
N-MSA	800.00	100.00
5.7.7 <u>High Capacity Digital DS1 (1.544 Mbps) Facilities</u>		
(A) <u>Standard Arrangements</u>		
Special Access Line		
Price Band A	\$ 450.00	\$ 234.00
Price Band B	450.00	234.00
Price Band C	450.00	234.00
N-MSA	450.00	226.00
N-MSA (See Note 1)	450.00	234.00
Each Additional System	130.00	100.00*

Note: N-MSA rates apply to Special Access Lines terminating at end user locations.

*DS1 Additional System is available only to Existing Customers as of October 31, 1998.

Issued: May 10, 2011

Effective: July 1, 2011

By Kenneth Mason
Vice President
of Government and Regulatory Affairs

Applies to All Exchanges Illinois

FACILITIES FOR INTRASTATE ACCESS

5. SPECIAL ACCESS (Cont'd)5.7 Rates and Charges (Cont'd)

	<u>Nonrecurring Charge</u>	<u>Monthly Rate</u>
<u>5.7.7 High Capacity Digital DS1 (1.544 Mbps) Facilities</u>		
<u>(A) Standard Arrangements</u>		
Special Transport Termination		
Price Band A		25.45
Price Band B		25.45
Price Band C		25.45
N-MSA		24.07
Special Transport Facility		
Per Airline Mile		
Price Band A		8.32
Price Band B		8.32
Price Band C		8.32
N-MSA		7.86
<u>(B) Optional Arrangements</u>		
<u>Supplemental Features</u>		
Automatic Protection Switching		
Price Band A	700.00	100.00
Price Band B	700.00	100.00
Price Band C	700.00	100.00
N-MSA	700.00	100.00

Note 1: Rates applicable to Special Access Lines terminating at end user locations only.

Applies to All Exchanges Illinois

FACILITIES FOR INTRASTATE ACCESS

5. SPECIAL ACCESS (Cont'd)5.7 Rates and Charges (Cont'd)

	<u>Nonrecurring Charge</u>	<u>Monthly Rate</u>
<u>5.7.7 High Capacity Digital DS1 (1.544 Mbps) Facilities</u> (Cont'd)		
(C) <u>*DS1 Optional Payment Plan</u>		
First System DS1 Special Access Line		
One Year		\$ 216.00*
Three Year		194.00*
Five Year		173.00*

5.7.8 High Capacity Digital FiberConnect (6.312 Mbps)
Facilities(A) FiberConnect Optional Electrical Interface Payment Plan
Special Access Line

Nonrecurring Charge		
Price Rate A	\$ 1000.00	
Price Rate B	1000.00	
Price Rate C	1000.00	
N-MSA	1000.00	
One Year		
Price Rate A		\$ 1225.00
Price Rate B		1225.00
Price Rate C		1225.00
N-MSA		1225.00

Note: N-MSA rates apply to Special Access Lines terminating at end user locations.

*DS1 OPP is available only to Existing Customers as of October 31, 1998.

Applies to All Exchanges Illinois

FACILITIES FOR INTRASTATE ACCESS

5. SPECIAL ACCESS (Cont'd)5.7 Rates and Charges (Cont'd)

	<u>Nonrecurring Charge</u>	<u>Monthly Rate</u>
<u>5.7.8 High Capacity Digital FiberConnect (6.312 Mbps) Facilities</u>		
(A) <u>FiberConnect Optional Electrical Interface Payment Plan Special Access Line</u>		
Three Year		
Price Rate A		1102.50
Price Rate B		1102.50
Price Rate C		1102.50
N-MSA		1102.50
Five Year		
Price Rate A		980.00
Price Rate B		980.00
Price Rate C		980.00
N-MSA		980.00
(B) <u>FiberConnect Optional Payment Optical Interface Plan Special Access Line</u>		
Optical Interface		
Nonrecurring Charge		
Price Rate A	\$ 1000.00	
Price Rate B	1000.00	
Price Rate C	1000.00	
N-MSA	1000.00	

Note: N-MSA rates apply to Special Access Lines terminating at end user locations.

*DS1 OPP is available only to Existing Customers as of October 31, 1998.

Issued: May 10, 2011

Effective: July 1, 2011

By Kenneth Mason
Vice President
of Government and Regulatory Affairs

Applies to All Exchanges Illinois

FACILITIES FOR INTRASTATE ACCESS

5. SPECIAL ACCESS (Cont'd)5.7 Rates and Charges (Cont'd)

	<u>Nonrecurring Charge</u>	<u>Monthly Rate</u>
5.7.8 <u>High Capacity Digital FiberConnect (6.312 Mbps)</u> <u>Facilities</u> (Cont'd)		
(B) <u>FiberConnect Optional Payment Optical Interface Plan</u> <u>Special Access Line</u> (Cont'd)		
One Year		
Price Rate A		\$ 1000.00
Price Rate B		1000.00
Price Rate C		1000.00
N-MSA		1000.00
Three Year		
Price Rate A		900.00
Price Rate B		900.00
Price Rate C		900.00
N-MSA		900.00
Five Year		
Price Rate A		800.00
Price Rate B		800.00
Price Rate C		800.00
N-MSA		800.00

Note: N-MSA rates apply to Special Access Lines terminating at end user locations.

Issued: May 10, 2011

Effective: July 1, 2011

By Kenneth Mason
Vice President
of Government and Regulatory Affairs

Applies to All Exchanges Illinois

FACILITIES FOR INTRASTATE ACCESS

5. SPECIAL ACCESS (Cont'd)5.7 Rates and Charges (Cont'd)5.7.9 High Capacity Digital FT1 Facilities

	<u>Special Access Line</u>		<u>Special</u>	<u>Special</u>
	<u>NRC</u>	<u>Monthly Rate</u>	<u>Transport</u>	<u>Transport Termination</u>
(A) <u>Standard Arrangement</u>				
- 2 x 56 Kbps or 2 x 64 Kbps				
Price Band A	\$ 450.00	\$ 121.69	\$ 6.00	\$ 20.00
Price Band B	450.00	121.69	6.00	20.00
Price Band C	450.00	121.69	6.00	20.00
N-MSA	450.00	121.69	6.00	20.00
- 4 x 56 Kbps or 4 x 64 Kbps				
Price Band A	450.00	129.12	7.00	30.00
Price Band B	450.00	129.12	7.00	30.00
Price Band C	450.00	129.12	7.00	30.00
N-MSA	450.00	129.12	7.00	30.00
- 6 x 56 Kbps or 6 x 64 Kbps				
Price Band A	450.00	136.56	8.00	40.00
Price Band B	450.00	136.56	8.00	40.00
Price Band C	450.00	136.56	8.00	40.00
N-MSA	450.00	136.56	8.00	40.00

Note: N-MSA rates apply to Special Access Lines terminating at end user locations.

Applies to All Exchanges Illinois

FACILITIES FOR INTRASTATE ACCESS

5. SPECIAL ACCESS (Cont'd)5.7 Rates and Charges (Cont'd)5.7.9 High Capacity Digital FT1 Facilities (Cont'd)

	<u>Special Access Line</u>			<u>Special</u>	<u>Special</u>
	<u>Monthly Rate</u>	<u>Special</u>	<u>Transport</u>		
	<u>One Year</u>	<u>Three Year</u>	<u>Five Year</u>	<u>Transport</u>	<u>Termination</u>
(B) <u>FT1 Optional Payment Plan</u>					
- 2 x 56 Kbps or 2 x 64 Kbps					
Price Rate A	\$ 110.00	\$ 99.00	\$ 88.00	\$ 6.00	\$ 20.00
Price Rate B	110.00	99.00	88.00	6.00	20.00
Price Rate C	110.00	99.00	88.00	6.00	20.00
N-MSA	110.00	99.00	88.00	6.00	20.00
- 4 x 56 Kbps or 4 x 64 Kbps					
Price Rate A	120.00	108.00	96.00	7.00	30.00
Price Rate B	120.00	108.00	96.00	7.00	30.00
Price Rate C	120.00	108.00	96.00	7.00	30.00
N-MSA	120.00	108.00	96.00	7.00	30.00
- 6 x 56 Kbps or 6 x 64 Kbps					
Price Rate A	130.00	117.00	104.00	8.00	40.00
Price Rate B	130.00	117.00	104.00	8.00	40.00
Price Rate C	130.00	117.00	104.00	8.00	40.00
N-MSA	130.00	117.00	104.00	8.00	40.00

Note: N-MSA rates apply to Special Access Lines terminating at end user locations.

Applies to All Exchanges Illinois

FACILITIES FOR INTRASTATE ACCESS

5. SPECIAL ACCESS (Cont'd)5.7 Rates and Charges (Cont'd)5.7.10 High Capacity Digital DS3 (44.736 Mbps) Facilities -
Three System(A) Protected DS3-
With Telephone Company ElectronicsFirst Special Access Line

	<u>Nonrecurring Charge</u>	<u>One Year Rate*</u>	<u>Three Year Rate*</u>	<u>Five Year Rate*</u>	<u>Seven Year Rate*</u>
Price Band A	\$2,500.00	\$1,480.00	\$1,240.00	\$1,108.00	\$1,040.00
Price Band B	2,500.00	1,480.00	1,240.00	1,108.00	1,040.00
Price Band C	2,500.00	1,480.00	1,240.00	1,108.00	1,040.00
N-MSA	2,500.00	1,480.00	1,240.00	1,108.00	1,040.00

Without Telephone Company ElectronicsFirst Special Access Line

	<u>Nonrecurring Charge</u>	<u>One Year Rate*</u>	<u>Three Year Rate*</u>	<u>Five Year Rate*</u>	<u>Seven Year Rate*</u>
Price Band A	1,875.00	1,133.00	954.00	840.00	790.75
Price Band B	1,875.00	1,133.00	954.00	840.00	790.75
Price Band C	1,875.00	1,133.00	954.00	840.00	790.75
N-MSA	1,875.00	1,133.00	954.00	840.00	790.75

Note: N-MSA rates apply to Special Access Lines terminating at end user locations.

* This is a Monthly Rate.

Issued: May 10, 2011

Effective: July 1, 2011

By Kenneth Mason
Vice President
of Government and Regulatory Affairs

Applies to All Exchanges Illinois

FACILITIES FOR INTRASTATE ACCESS

5. SPECIAL ACCESS (Cont'd)5.7 Rates and Charges (Cont'd)5.7.10 High Capacity Digital DS3 (44.736 Mbps) Facilities -
Three System (Cont'd)(A) Protected DS3 (Cont'd)Each Additional Special Access Line - Maximum of 2

	<u>Nonrecurring Charge</u>	<u>One Year Rate*</u>	<u>Three Year Rate*</u>	<u>Five Year Rate*</u>	<u>Seven Year Rate*</u>
Price Band A	\$1,000.00	\$1,110.00	\$ 930.00	\$ 831.00	\$ 780.00
Price Band B	1,000.00	1,110.00	930.00	831.00	780.00
Price Band C	1,000.00	1,110.00	930.00	831.00	780.00
N-MSA	1,000.00	1,110.00	930.00	831.00	780.00

Without Telephone Company ElectronicsEach Additional Special Access Line - Maximum of 2

	<u>Nonrecurring Charge</u>	<u>One Year Rate*</u>	<u>Three Year Rate*</u>	<u>Five Year Rate*</u>	<u>Seven Year Rate*</u>
Price Band A	750.00	849.75	715.50	630.00	593.00
Price Band B	750.00	849.75	715.50	630.00	593.00
Price Band C	750.00	849.75	715.50	630.00	593.00
N-MSA	750.00	849.75	715.50	630.00	593.00

Note: N-MSA rates apply to Special Access Lines terminating at end user locations.

* This is a monthly rate.

Issued: May 10, 2011

Effective: July 1, 2011

By Kenneth Mason
Vice President
of Government and Regulatory Affairs

Applies to All Exchanges Illinois

FACILITIES FOR INTRASTATE ACCESS

5. SPECIAL ACCESS (Cont'd)5.7 Rates and Charges (Cont'd)5.7.11 High Capacity Digital DS3 (44.736 Mbps) Facilities - Unlimited System(A) Protected DS3- (Cont'd)
With Telephone Company ElectronicsFirst Special Access Line

	<u>Nonrecurring Charge</u>	<u>One Year Rate*</u>	<u>Three Year Rate*</u>	<u>Five Year Rate*</u>	<u>Seven Year Rate*</u>
Price Band A	\$4,500.00	\$4,242.00	\$3,605.75	\$3,252.25	\$2,898.75
Price Band B	4,500.00	4,242.00	3,605.75	3,252.25	2,898.75
Price Band C	4,500.00	4,242.00	3,605.75	3,252.25	2,898.75
N-MSA	4,500.00	4,242.00	3,605.75	3,252.25	2,898.75

Without Telephone Company ElectronicsFirst Special Access Line

	<u>Nonrecurring Charge</u>	<u>One Year Rate*</u>	<u>Three Year Rate*</u>	<u>Five Year Rate*</u>	<u>Seven Year Rate*</u>
Price Band A	\$3,375.00	\$2,887.25	\$2,454.25	\$2,213.75	\$1,973.00
Price Band B	3,375.00	2,887.25	2,454.25	2,213.75	1,973.00
Price Band C	3,375.00	2,887.25	2,454.25	2,213.75	1,973.00
N-MSA	3,375.00	2,887.25	2,454.25	2,213.75	1,973.00

Note: N-MSA rates apply to Special Access Lines terminating at end user locations.

* This is a monthly rate.

Issued: May 10, 2011

Effective: July 1, 2011

By Kenneth Mason
Vice President
of Government and Regulatory Affairs

Applies to All Exchanges Illinois

FACILITIES FOR INTRASTATE ACCESS

5. SPECIAL ACCESS (Cont'd)5.7 Rates and Charges (Cont'd)5.7.11 High Capacity Digital DS3 (44.736 Mbps) Facilities - Unlimited System (Cont'd)(A) Protected DS3
With Telephone Company Electronics (Cont'd)Each Additional Special Access Line

	<u>Nonrecurring Charge</u>	<u>One Year Rate*</u>	<u>Three Year Rate*</u>	<u>Five Year Rate*</u>	<u>Seven Year Rate*</u>
Price Band A	\$1,000.00	\$ 450.00	\$ 396.25	\$ 365.00	\$ 341.00
Price Band B	1,000.00	450.00	396.25	365.00	341.00
Price Band C	1,000.00	450.00	396.25	365.00	341.00
N-MSA	1,000.00	450.00	396.25	365.00	341.00

Without Telephone Company ElectronicsEach Additional Special Access Line

	<u>Nonrecurring Charge</u>	<u>One Year Rate*</u>	<u>Three Year Rate*</u>	<u>Five Year Rate*</u>	<u>Seven Year Rate*</u>
Price Band A	750.00	437.00	390.75	332.75	314.50
Price Band B	750.00	437.00	390.75	332.75	314.50
Price Band C	750.00	437.00	390.75	332.75	314.50
N-MSA	750.00	437.00	390.75	332.75	314.50

Note: N-MSA rates apply to Special Access Lines terminating at end user locations.

Issued: May 10, 2011

Effective: July 1, 2011

By Kenneth Mason
Vice President
of Government and Regulatory Affairs

Applies to All Exchanges Illinois

FACILITIES FOR INTRASTATE ACCESS

5. SPECIAL ACCESS (Cont'd)5.7 Rates and Charges (Cont'd)5.7.12 High Capacity Digital DS3 (44.736 Mbps) Facilities - Individual System(A) Protected DS3-Individual
With Telephone Company Electronics

	<u>Nonrecurring Charge</u>	<u>One Year Rate*</u>	<u>Three Year Rate*</u>	<u>Five Year Rate*</u>	<u>Seven Year Rate*</u>
Price Band A	\$1,000.00	\$ 1,200.00	\$1,000.00	\$ 890.00	\$ 805.00
Price Band B	1,000.00	1,200.00	1,000.00	890.00	805.00
Price Band C	1,000.00	1,200.00	1,000.00	890.00	805.00
N-MSA	1,000.00	1,125.00	950.00	825.00	795.00

Without Telephone Company ElectronicsEach Special Access Line

	<u>Nonrecurring Charge</u>	<u>One Year Rate*</u>	<u>Three Year Rate*</u>	<u>Five Year Rate*</u>	<u>Seven Year Rate*</u>
Price Band A	750.00	885.00	725.00	650.00	538.00
Price Band B	750.00	885.00	725.00	650.00	538.00
Price Band C	750.00	885.00	725.00	650.00	538.00
N-MSA	750.00	885.00	725.00	650.00	538.00

Note: N-MSA rates apply to Special Access Lines terminating at end user locations.

* This is a monthly rate.

Applies to All Exchanges Illinois

FACILITIES FOR INTRASTATE ACCESS

5. SPECIAL ACCESS (Cont'd)5.7 Rates and Charges (Cont'd)5.7.13 High Capacity Digital DS3 (44.736 Mbps) Facilities -
Group System**(A) Protected DS3 X 12
With Telephone Company Electronics**Each Special Access Line - Per Group of 12**

	<u>Nonrecurring Charge</u>	<u>One Year Rate*</u>	<u>Three Year Rate*</u>	<u>Five Year Rate*</u>	<u>Seven Year Rate*</u>
Price Band A	\$7,000.00	\$8,450.00	\$7,000.00	\$5,300.00	\$4,500.00
Price Band B	7,000.00	8,450.00	7,000.00	5,300.00	4,500.00
Price Band C	7,000.00	8,450.00	7,000.00	5,300.00	4,500.00
N-MSA	7,000.00	8,450.00	7,000.00	5,300.00	4,500.00

Without Telephone Company Electronics**Each Special Access Line - Per Group of 12**

	<u>Nonrecurring Charge</u>	<u>One Year Rate*</u>	<u>Three Year Rate*</u>	<u>Five Year Rate*</u>	<u>Seven Year Rate*</u>
Price Band A	5,250.00	6,337.50	5,250.00	3,975.00	3,375.00
Price Band B	5,250.00	6,337.50	5,250.00	3,975.00	3,375.00
Price Band C	5,250.00	6,337.50	5,250.00	3,975.00	3,375.00
N-MSA	5,250.00	6,337.50	5,250.00	3,975.00	3,375.00

Note: N-MSA rates apply to Special Access Lines terminating at end user locations.

*This is a monthly rate.

**Limited to those services so equipped and in service as of March 25, 1999.

Issued: May 10, 2011

Effective: July 1, 2011

By Kenneth Mason
Vice President
of Government and Regulatory Affairs

Applies to All Exchanges Illinois

FACILITIES FOR INTRASTATE ACCESS

5. SPECIAL ACCESS (Cont'd)

5.7 Rates and Charges (Cont'd)

5.7.13 High Capacity Digital DS3 (44.736 Mbps) Facilities -
 Group System** (Cont'd)

(B) Protected DS3 X 24
 With Telephone Company Electronics**

Each Special Access Line - Per Group of 24**

	<u>Nonrecurring Charge</u>	<u>One Year Rate*</u>	<u>Three Year Rate*</u>	<u>Five Year Rate*</u>	<u>Seven Year Rate*</u>
Price Band A	\$12,000.00	\$14,500.00	\$12,000.00	\$9,000.00	\$7,800.00
Price Band B	12,000.00	14,500.00	12,000.00	9,000.00	7,800.00
Price Band C	12,000.00	14,500.00	12,000.00	9,000.00	7,800.00
N-MSA	12,000.00	14,500.00	12,000.00	9,000.00	7,800.00

Without Telephone Company Electronics**

Each Special Access Line - Per Group of 24**

	<u>Nonrecurring Charge</u>	<u>One Year Rate*</u>	<u>Three Year Rate*</u>	<u>Five Year Rate*</u>	<u>Seven Year Rate*</u>
Price Band A	9,000.00	10,875.00	9,000.00	6,750.00	5,850.00
Price Band B	9,000.00	10,875.00	9,000.00	6,750.00	5,850.00
Price Band C	9,000.00	10,875.00	9,000.00	6,750.00	5,850.00
N-MSA	9,000.00	10,875.00	9,000.00	6,750.00	5,850.00

Note: N-MSA rates apply to Special Access Lines terminating at end user locations.

*Limited to those services so equipped and in service as of March 25, 1999.

Issued: May 10, 2011

Effective: July 1, 2011

By Kenneth Mason
 Vice President
 of Government and Regulatory Affairs

Applies to All Exchanges Illinois

FACILITIES FOR INTRASTATE ACCESS

5. SPECIAL ACCESS (Cont'd)5.7 Rates and Charges (Cont'd)5.7.14 High Capacity Digital DS3 (44.736 Mbps) Facilities - Special TransportMonthly Rate(A) DS3 Special Transport Facility, Per Airline MileIndividual, 3 System, Unlimited Transport
Per DS3, Per Airline Mile

Price Band A	\$ 33.75
Price Band B	33.75
Price Band C	33.75
N-MSA	30.00

12 Group System*Transport, Per Group of 12,
Per Airline Mile

Price Band A	215.00
Price Band B	215.00
Price Band C	215.00
N-MSA	215.00

24 Group System*Transport, Per Group of 24,
Per Airline Mile

Price Band A	300.00
Price Band B	300.00
Price Band C	300.00
N-MSA	300.00

*Limited to those services so equipped and in service as of March 25, 1999.

Applies to All Exchanges Illinois

FACILITIES FOR INTRASTATE ACCESS

5. SPECIAL ACCESS (Cont'd)5.7 Rates and Charges (Cont'd)5.7.14 High Capacity Digital DS3 (44.736 Mbps) Facilities - Special Transport
(Cont'd)Monthly Rate(B) DS3 Special Transport Termination

Individual, 3 System, Unlimited Transport Per DS3, Per Termination	
Price Band A	\$ 335.75
Price Band B	335.75
Price Band C	335.75
N-MSA	275.00
12 Group System*Transport, Per Group of 12, Per Termination	
Price Band A	2,500.00
Price Band B	2,500.00
Price Band C	2,500.00
N-MSA	2,500.00
24 Group System*Transport, Per Group of 24, Per Termination	
Price Band A	4,500.00
Price Band B	4,500.00
Price Band C	4,500.00
N-MSA	4,500.00

*Limited to those services so equipped and in service as of March 25, 1999.

Applies to All Exchanges Illinois

FACILITIES FOR INTRASTATE ACCESS

5. SPECIAL ACCESS (Cont'd)5.7 Rates and Charges (Cont'd)5.7.15 High Capacity Digital DS3 (44.736 Mbps) FacilitiesDS3 Multiplexer Cross Connect Arrangement

	<u>Nonrecurring Charge</u>
Per Arrangement	
Price Band A	65.00
Price Band B	65.00
Price Band C	65.00
N-MSA	65.00

5.7.16 Four-Wire Voiceband and Digital Data Service (DDS) Rate Stability Plan (RSP)

	<u>Monthly Recurring Charge</u>	
	<u>Three Year</u>	<u>Five Year</u>
(A) <u>Rates</u>		
<u>Special Access Line</u>		
Four-Wire Voiceband		
Price Band A	\$28.15	\$26.67
Price Band B	28.15	26.67
Price Band C	28.15	26.67
N-MSA	28.15	26.67
DDS		
2.4, 4.8, 9.6, 19.2 Kbps		
Price Band A	52.25	49.50
Price Band B	52.25	49.50
Price Band C	52.25	49.50
N-MSA	52.25	49.50
56, 64 Kbps		
Price Band A	64.60	61.20
Price Band B	64.60	61.20
Price Band C	64.60	61.20
N-MSA	64.60	61.20

Note: N-MSA rates apply to Special Access Lines terminating at end user locations.

Applies to All Exchanges Illinois

FACILITIES FOR INTRASTATE ACCESS

5. SPECIAL ACCESS (Cont'd)5.7 Rates and Charges (Cont'd)5.7.16 Four-Wire Voiceband and Digital Data Service (DDS) Rate Stability Plan (RSP) (Cont'd)

	<u>Monthly Recurring Charge</u>	
	<u>Three Year</u>	<u>Five Year</u>
(A) <u>Rates</u> (Cont'd)		
<u>Special Transport</u> Per Airline Mile		
Four-Wire Voiceband		
Price Band A	\$ 2.60	\$ 2.47
Price Band B	2.60	2.47
Price Band C	2.60	2.47
N-MSA	2.60	2.47
DDS, All Speeds		
Price Band A	2.22	2.09
Price Band B	2.22	2.09
Price Band C	2.22	2.09
N-MSA	2.22	2.09

5.7.17 DS1 Term Volume Plan (TVP) #

(T)

	<u>Nonrecurring Charge</u>
(A) <u>Special Access Line, per DS1 SAL</u>	
Price Band A	\$ 450.00
Price Band B	450.00
Price Band C	450.00
N-MSA	450.00

Services are only available to current service subscribers as of 9/23/13 at their current locations.

(N)

Issued: August 8, 2013

Effective: September 23, 2013

By Kenneth Mason
Vice President
of Government and Regulatory Affairs

Applies to All Exchanges Illinois

FACILITIES FOR INTRASTATE ACCESS

5. SPECIAL ACCESS (Cont'd)5.7 Rates and Charges (Cont'd)5.7.17 DS1 Term Volume Plan (TVP) # (Cont'd)

(T)

Monthly
Rate(A) Special Access Line, per DS1 SAL (Cont'd)

(1) One Year Term, Threshold Levels:

2-60	
Price Band A	\$ 207.00
Price Band B	207.00
Price Band C	207.00
N-MSA	194.10
61-120	
Price Band A	197.00
Price Band B	197.00
Price Band C	197.00
N-MSA	184.71
121-240	
Price Band A	187.00
Price Band B	187.00
Price Band C	187.00
N-MSA	175.32
241-500	
Price Band A	177.00
Price Band B	177.00
Price Band C	177.00
N-MSA	165.92
501-1000	
Price Band A	175.00
Price Band B	175.00
Price Band C	175.00
N-MSA	163.84

Note: N-MSA rates apply to Special Access Lines terminating at end user locations.

Services are only available to current service subscribers as of 9/23/13 at their current locations.
 Issued: August 8, 2013 Effective: September 23, 2013

(N)

By Kenneth Mason
 Vice President
 of Government and Regulatory Affairs

Applies to All Exchanges Illinois

FACILITIES FOR INTRASTATE ACCESS

5. SPECIAL ACCESS (Cont'd)

5.7 Rates and Charges (Cont'd)

5.7.17 DS1 Term Volume Plan (TVP) # (Cont'd)

(T)

Monthly
 Rate

(A) Special Access Line, per DS1 SAL (Cont'd)

(1) One Year Term, Threshold Levels:

1001-3000	
Price Band A	173.00
Price Band B	173.00
Price Band C	173.00
N-MSA	162.79
3001-6000	
Price Band A	171.00
Price Band B	171.00
Price Band C	171.00
N-MSA	160.71

Note: N-MSA rates apply to Special Access Lines terminating at end user locations.

Services are only available to current service subscribers as of 9/23/13 at their current locations. (N)

Applies to All Exchanges Illinois

FACILITIES FOR INTRASTATE ACCESS

5. SPECIAL ACCESS (Cont'd)

5.7 Rates and Charges (Cont'd)

5.7.17 DS1 Term Volume Plan (TVP) # (Cont'd)

(T)

	<u>Monthly Rate</u>
(A) <u>Special Access Line, per DS1 SAL</u> (Cont'd)	

(1) One Year Term, Threshold Levels: (Cont'd)

6001-11000	
Price Band A	\$ 169.00
Price Band B	169.00
Price Band C	169.00
N-MSA	158.62
11001 and over	
Price Band A	167.00
Price Band B	167.00
Price Band C	167.00
N-MSA	156.53

(2) Two Year Term, Threshold Levels:

2-60	
Price Band A	197.00
Price Band B	197.00
Price Band C	197.00
N-MSA	184.71
61-120	
Price Band A	187.00
Price Band B	187.00
Price Band C	187.00
N-MSA	175.32
121-240	
Price Band A	177.00
Price Band B	177.00
Price Band C	177.00
N-MSA	165.92

Note: N-MSA rates apply to Special Access Lines terminating at end user locations.

Services are only available to current service subscribers as of 9/23/13 at their current locations.

(N)

Issued: August 8, 2013

Effective: September 23, 2013

By Kenneth Mason
 Vice President
 of Government and Regulatory Affairs

Applies to All Exchanges Illinois

FACILITIES FOR INTRASTATE ACCESS

5. SPECIAL ACCESS (Cont'd)5.7 Rates and Charges (Cont'd)5.7.17 DS1 Term Volume Plan (TVP) # (Cont'd)

(T)

Monthly
Rate(A) Special Access Line, per DS1 SAL (Cont'd)

(2) Two Year Term, Threshold Levels:

241-500	
Price Band A	167.00
Price Band B	167.00
Price Band C	167.00
N-MSA	156.53
501-1000	
Price Band A	165.00
Price Band B	165.00
Price Band C	165.00
N-MSA	154.45

Note: N-MSA rates apply to Special Access Lines terminating at end user locations.

Services are only available to current service subscribers as of 9/23/13 at their current locations. (N)

Issued: August 8, 2013

Effective: September 23, 2013

By Kenneth Mason
Vice President
of Government and Regulatory Affairs

Applies to All Exchanges Illinois

FACILITIES FOR INTRASTATE ACCESS

5. SPECIAL ACCESS (Cont'd)5.7 Rates and Charges (Cont'd)5.7.17 DS1 Term Volume Plan (TVP) # (Cont'd)

(T)

Monthly
Rate(A) Special Access Line, per DS1 SAL (Cont'd)

(2) Two Year Term, Threshold Levels: (Cont'd)

1001-3000	
Price Band A	\$ 163.00
Price Band B	163.00
Price Band C	163.00
N-MSA	153.40
3001-6000	
Price Band A	161.00
Price Band B	161.00
Price Band C	161.00
N-MSA	151.31
6001-11000	
Price Band A	159.00
Price Band B	159.00
Price Band C	159.00
N-MSA	149.23
11001 and over	
Price Band A	157.00
Price Band B	157.00
Price Band C	157.00
N-MSA	147.14

Note: N-MSA rates apply to Special Access Lines terminating at end user locations.

Services are only available to current service subscribers as of 9/23/13 at their current locations.

(N)

Issued: August 8, 2013

Effective: September 23, 2013

By Kenneth Mason
Vice President
of Government and Regulatory Affairs

Applies to All Exchanges Illinois

FACILITIES FOR INTRASTATE ACCESS

5. SPECIAL ACCESS (Cont'd)5.7 Rates and Charges (Cont'd)5.7.17 DS1 Term Volume Plan (TVP) # (Cont'd)

(T)

Monthly
Rate(A) Special Access Line, per DS1 SAL (Cont'd)

(3) Three Year Term, Threshold Levels:

2-60

Price Band A	187.00
Price Band B	187.00
Price Band C	187.00
N-MSA	175.32

61-120

Price Band A	177.00
Price Band B	177.00
Price Band C	177.00
N-MSA	165.92

121-240

Price Band A	167.00
Price Band B	167.00
Price Band C	167.00
N-MSA	156.53

Note: N-MSA rates apply to Special Access Lines terminating at end user locations.

Services are only available to current service subscribers as of 9/23/13 at their current locations. (N)

Issued: August 8, 2013

Effective: September 23, 2013

By Kenneth Mason
Vice President
of Government and Regulatory Affairs

Applies to All Exchanges Illinois

FACILITIES FOR INTRASTATE ACCESS

5. SPECIAL ACCESS (Cont'd)5.7 Rates and Charges (Cont'd)5.7.17 DS1 Term Volume Plan (TVP) # (Cont'd)

(T)

Monthly
Rate(A) Special Access Line, per DS1 SAL (Cont'd)

(3) Three Year Term, Threshold Levels: (Cont'd)

241-500

Price Band A	\$ 157.00
Price Band B	157.00
Price Band C	157.00
N-MSA	147.14

501-1000

Price Band A	155.00
Price Band B	155.00
Price Band C	155.00
N-MSA	145.05

1001-3000

Price Band A	153.00
Price Band B	153.00
Price Band C	153.00
N-MSA	144.01

3001-6000

Price Band A	151.00
Price Band B	151.00
Price Band C	151.00
N-MSA	141.92

6001-11000

Price Band A	149.00
Price Band B	149.00
Price Band C	149.00
N-MSA	139.84

Note: N-MSA rates apply to Special Access Lines terminating at end user locations.

Services are only available to current service subscribers as of 9/23/13 at their current locations.

(N)

Issued: August 8, 2013

Effective: September 23, 2013

By Kenneth Mason
Vice President
of Government and Regulatory Affairs

Applies to All Exchanges Illinois

FACILITIES FOR INTRASTATE ACCESS

5. SPECIAL ACCESS (Cont'd)

5.7 Rates and Charges (Cont'd)

5.7.17 DS1 Term Volume Plan (TVP) # (Cont'd)

	Monthly <u>Rate</u>	(T)
(A) <u>Special Access Line, per DS1 SAL</u> (Cont'd)		
(3) Three Year Term, Threshold Levels: (Cont'd)		
11001 and over		
Price Band A	147.00	
Price Band B	147.00	
Price Band C	147.00	
N-MSA	137.75	
(4) Five Year Term, Threshold Levels:		
2-60		
Price Band A	\$167.00	
Price Band B	167.00	
Price Band C	167.00	
N-MSA	156.53	
61-120		
Price Band A	157.00	
Price Band B	157.00	
Price Band C	157.00	
N-MSA	147.14	
121-240		
Price Band A	147.00	
Price Band B	147.00	
Price Band C	147.00	
N-MSA	137.75	
241-500		
Price Band A	135.00	
Price Band B	135.00	
Price Band C	135.00	
N-MSA	126.27	

Note: N-MSA rates apply to Special Access Lines terminating at end user locations. (N)
Services are only available to current service subscribers as of 9/23/13 at their current locations.

Issued: August 8, 2013

Effective: September 23, 2013

By Kenneth Mason
 Vice President
 of Government and Regulatory Affairs

Applies to All Exchanges Illinois

FACILITIES FOR INTRASTATE ACCESS

5. SPECIAL ACCESS (Cont'd)5.7 Rates and Charges (Cont'd)5.7.17 DS1 Term Volume Plan (TVP) # (Cont'd)

(T)

Monthly
Rate(A) Special Access Line, per DS1 SAL (Cont'd)

(4) Five Year Term, Threshold Levels:

501-1000

Price Band A	133.00
Price Band B	133.00
Price Band C	133.00
N-MSA	125.23

1001-3000

Price Band A	\$ 131.00
Price Band B	131.00
Price Band C	131.00
N-MSA	123.14

3001-6000

Price Band A	129.00
Price Band B	129.00
Price Band C	129.00
N-MSA	121.05

6001-11000

Price Band A	127.00
Price Band B	127.00
Price Band C	127.00
N-MSA	118.96

11001 and over

Price Band A	125.00
Price Band B	125.00
Price Band C	125.00
N-MSA	116.88

Note: N-MSA rates apply to Special Access Lines terminating at end user locations.

Services are only available to current service subscribers as of 9/23/13 at their current locations.

(N)

Issued: August 8, 2013

Effective: September 23, 2013

By Kenneth Mason
Vice President
of Government and Regulatory Affairs

Applies to All Exchanges Illinois

FACILITIES FOR INTRASTATE ACCESS

5. SPECIAL ACCESS (Cont'd)5.8 Miscellaneous Special Access Services5.8.1 Clear Channel Capability (CCO)(A) Description of Service

An arrangement that allows the customer to transport 1.536 Mbps of information through a DS1 with no constraint on the quantity or sequence of one (mark) and zero (space) bits utilizing the Bipolar with Eight Zero Substitution (B8ZS) method of providing bit sequence independence. This arrangement is capable of transporting DS1 signals which utilize Superframe or Extended Superframe Format (ESF) as defined by the American National Standards Institute (ANSI) T1.107-1988 standard. The installation interval for Clear Channel Capability may exceed standard intervals where equipment in the central office is not readily available. The charges apply on a per SAL basis.

This arrangement requires the customer signal at the channel interface to conform to the B8ZS method of providing bit sequence independence, as described in ANSI T1.102-1987 and Section 6103 of the Technical Interface Reference Manual.

(B) Rates

Nonrecurring Charge	\$90.00
Monthly Rate	24.00

5.9 Special Access Cross Connect Rates and Charges

	Monthly
	<u>Rate</u>
DSO	\$ 1.77
DS1, per DS1 Connection	4.53
DS3, per DS3 Connection	36.64

Issued: May 10, 2011

Effective: July 1, 2011

By Kenneth Mason
Vice President
of Government and Regulatory Affairs

Applies to All Exchanges Illinois

FACILITIES FOR INTRASTATE ACCESS

SECTION 6 TABLE OF CONTENTS

6. MISCELLANEOUS SERVICES.....	Page
6.1 <u>General</u>	4
6.2 <u>Additional Labor</u>	5
(A) Overtime Installation (ALH)	5
(B) Overtime Repair (ALH).....	5
(C) Additional Installation Testing (ALH)	5
(D) Standby (ALT)	6
(E) Testing and Maintenance with Other Telephone Companies (ALK)	6
(F) Other Labor (ALK)	6
(G) Charges for Additional Labor	7
6.3 <u>Maintenance of Service Charge</u>	9
6.4 <u>Telecommunications Service Priority (TSP) System</u>	11
(A) Description of the Service.....	11
(B) Obtaining TSP System Service.....	11
(C) Provisioning Priority	12
(D) Restoration Priority	12
(E) Obligations of the Customer.....	13
(F) Obligations of the Telephone Company.....	14
(G) Rates and Charges	15

Applies to All Exchanges Illinois

FACILITIES FOR INTRASTATE ACCESS

SECTION 6 TABLE OF CONTENTS (Cont'd)

6.	MISCELLANEOUS SERVICES (Cont'd).....	<u>Page</u>
6.5	<u>Balloting and Allocation Process For Equal Access</u>	17
	(A) IPIC Charge Application	17
	(B) Unauthorized Primary IntraMSA Carrier (IPIC) Restoral Change	18
	(C) Liability of the Telephone Company.....	19
	(D) Carrier Desired Due Date (ICDDD) for IPIC Installation.....	19
	(E) Nonrecurring Charge for Primary IntraMSA Carrier (IPIC)....	19
	(F) IC CIC Consolidation	20
	(G) Nonrecurring Charge for IC CIC Consolidation	20
6.6	Additional Testing.....	21
	(A) Switched Access Testing.....	22
	(1) Additional Cooperative Acceptance Testing	22
	(2) Automatic Scheduled Testing.....	22
	(3) Additional Cooperative Scheduled Testing	23
	(4) Additional Manual Scheduled Testing	24
	(5) Nonscheduled Testing	24
	(6) Obligation of the Customer	26
	(B) Special Access Testing.....	26
	(1) Additional Cooperative Acceptance Testing	26
	(2) Nonscheduled Testing	27
	(3) Obligation of the Customer	27
	(C) Rates and Charges	28
	(1) Automatic Scheduled Testing.....	28
	(2) Additional Cooperative Scheduled Testing	28
	(3) Additional Manual Scheduled Testing	28

Applies to All Exchanges Illinois

FACILITIES FOR INTRASTATE ACCESS

SECTION 6 TABLE OF CONTENTS

6. MISCELLANEOUS SERVICES (Cont'd)	<u>Page</u>	
6.7 <u>End User/Agent Lists</u>	29	
(A) Presubscription List.....	29	
(B) Allocation Lists	33	
(C) Snapshot List	33	
(D) Line Range Reports - Lines Not Available for Subscription	34	
6.7.1 Rates and Charges	34	
(A) Initial and Allocation Lists	34	
(B) Snapshot List	34	
(C) Line Range Reports – (NRBZR)	34	
6.8 <u>Billing Name and Address Service</u>	35	
(A) Per Call/Periodic BNA and Data Gathering Service.....	35	
(B) End User Validation List.....	37	
6.8.1 Rates and Charges	38	
(A) Per Call/Periodic BNA	38	
(B) Data Gathering Service	38	
(C) End User Validation List.....	39	
6.9 <u>Denial/Restoral Service</u>	39	
6.10 <u>International Blocking Service</u>	40	
6.11 <u>Service Access Code 900 Blocking</u>	40	
6.12 <u>Selective Class of Call Screening (SCOCS)</u>	41	
6.13 <u>Answer Supervision</u>	42	
6.14 <u>Reserved For Future Use</u>	42	(C)
6.15 <u>DS1 Span Power</u>	43	

Applies to All Exchanges Illinois

FACILITIES FOR INTRASTATE ACCESS

6. MISCELLANEOUS SERVICES

6.1 General

Miscellaneous Services available to the customer include the following:

- (A) Additional Labor (i.e., Overtime Installation, Overtime Repair, Additional Installation Testing, Standby, Testing and Maintenance with Other Telephone Companies)
- (B) Maintenance of Service
- (C) Telecommunications Service Priority (TSP) System
- (D) Balloting and Allocation Process For Equal Access
- (E) Additional Testing
- (F) End User List
- (G) Billing Name and Address Service
- (H) Denial/Restoral Service
- (I) International Blocking Service
- (J) Service Access Code 900 Blocking
- (K) Selective Class of Call Screening
- (L) Answer Supervision
- (M) Payphone-Specific Coding Digits
- (N) DS1 Span Power

These services are described in detail as set forth in 6.2 through 6.15 following.

Applies to All Exchanges Illinois

FACILITIES FOR INTRASTATE ACCESS

6. MISCELLANEOUS SERVICES (Cont'd)

6.2 Additional Labor

Additional Labor is that labor requested by the customer on a given FIA and agreed to by the Telephone Company as set forth in (A) through (F) following. The Telephone Company will notify the customer that Additional Labor charges as set forth in (G) following will apply before any Additional Labor is undertaken. Additional Labor charges will also apply if the requirement for the Additional Labor is the fault of the customer or parties on whose behalf it acts.

(A) Overtime Installation (ALH)

Overtime installation is that Telephone Company installation effort outside the business day. Overtime rates will apply anytime outside the business day and all day Saturday. Premium time rates will apply all day Sunday and on all Telephone Company approved holidays. For applicable holidays, contact the Telephone Company.

(B) Overtime Repair (ALH)

Overtime repair is Telephone Company repair which could have been performed during the normal business day, but that is delayed at the specific request of the customer to a later time period which is outside the normal business day or to a weekend day or holiday. The request will result in the application of overtime rates anytime outside the business day and all day Saturday. Premium time rates will apply on Sunday and Telephone Company approved holidays. These rates, as set forth in Section 6.2 following, will only apply when there is a delay of repair at the request of the customer to the time periods stated above.

(C) Additional Installation Testing (ALH)

Additional installation testing is that testing performed by the Telephone Company at the time of installation which is in addition to normal pre-service and acceptance testing.

Applies to All Exchanges Illinois

FACILITIES FOR INTRASTATE ACCESS

6. MISCELLANEOUS SERVICES (Cont'd)

6.2 Additional Labor (Cont'd)

(D) Standby (ALT)

Standby includes all time in excess of one-half (1/2) hour during which Telephone Company personnel are available to make coordinated tests on a given FIA. The standby charge applies only when Telephone Company personnel must wait more than 30 minutes beyond a prearranged, mutually agreed appointment time. Standby charges will cease when testing begins, or when Telephone Company personnel are released from the standby requirement, or when testing is rescheduled for a later date or time. Charges will not be applicable if Telephone Company personnel cause the delay.

(E) Testing and Maintenance with Other Telephone Companies (ALK)

Additional testing, maintenance, or repair of facilities which connect to facilities of other telephone companies, which is in addition to normal effort required to test, maintain, or repair facilities provided solely by the Telephone Company.

(F) Other Labor (ALK)

Other labor is that additional labor not included in (A) through (E) preceding, and labor incurred to accommodate a specific customer request that involves only labor which is not covered by any other section of this Tariff.

Applies to All Exchanges Illinois

FACILITIES FOR INTRASTATE ACCESS

6. MISCELLANEOUS SERVICES (Cont'd)6.2 Additional Labor (Cont'd)(G) Charges for Additional Labor

- (1) The following rates apply for Additional Cooperative Acceptance Testing – Special, Additional Cooperative Testing – Switched, Maintenance of Service (see Section 6.3), Nonscheduled Testing – Special, Nonscheduled Testing – Switched, Other Labor (see Section 6.2(F)), Testing and Maintenance with Other Telephone Companies (see Section 6.2(E)):

<u>Labor Periods</u>	<u>First Half Hour or Fraction Thereof</u>	<u>Each Additional Half Hour or Fraction Thereof</u>
(a) Basic Time, Business Day, Per Technician	\$150.00	\$150.00
(b) Overtime, Outside the Business Day, Per Technician *	200.00	200.00
(c) Premium Time, Outside the Business Day, Per Technician *	250.00	250.00

*A call out of a Telephone Company employee at a time not consecutive with the business day is subject to a minimum charge of four hours.

Issued: May 10, 2011

Effective: July 1, 2011

By Kenneth Mason
Vice President
of Government and Regulatory Affairs

Applies to All Exchanges Illinois

FACILITIES FOR INTRASTATE ACCESS

6. MISCELLANEOUS SERVICES (Cont'd)6.2 Additional Labor (Cont'd)(G) Charges for Additional Labor (Cont'd)

- (2) The following rates apply for Additional Installation Testing (see Section 6.2(C)), Overtime Installation (see Section 6.2(A)), Overtime Repair (see Section 6.2(B)):

<u>Labor Periods</u>	<u>First Half Hour or Fraction Thereof</u>	<u>Each Additional Half Hour or Fraction Thereof</u>
(a) Basic Time, Business Day, Per Technician	\$ 27.60	\$ 18.40
(b) Overtime, Outside the Business Day, Per Technician *	100.00	75.00
(c) Premium Time, Outside the Business Day, Per Technician *	150.00	125.00

*A call out of a Telephone Company employee at a time not consecutive with the business day is subject to a minimum charge of four hours.

Issued: May 10, 2011

Effective: July 1, 2011

By Kenneth Mason
Vice President
of Government and Regulatory Affairs

Applies to All Exchanges Illinois

FACILITIES FOR INTRASTATE ACCESS

6. MISCELLANEOUS SERVICES (Cont'd)6.2 Additional Labor (Cont'd)(G) Charges for Additional Labor (Cont'd)

(3) The following rates apply for Standby (see Section 6.2(D)):

<u>Labor Periods</u>	<u>First Half Hour or Fraction Thereof</u>	<u>Each Additional Half Hour or Fraction Thereof</u>
(a) Basic Time, Business Day, Per Technician	\$0.00	\$60.00
(b) Overtime, Outside the Business Day, Per Technician *	0.00	70.00
(c) Premium Time, Outside the Business Day, Per Technician *	0.00	80.00

6.3 Maintenance of Service Charge

(A) When a customer reports trouble to the Telephone Company for clearance, the customer shall be responsible for payment of a Maintenance of Service Charge when Telephone Company personnel are dispatched to the customer's location and no trouble is found in the Telephone Company's facilities. Failure of Telephone Company personnel to find trouble in Telephone Company facilities will result in no charge if the trouble is actually in those facilities, but not discovered at the time.

In this case, or in (B) following, no credit allowance will be applicable for the interruption involved, unless the trouble is found in the Telephone Company's facilities.

* A call out of a Telephone Company employee at a time not consecutive with the business day is subject to a minimum charge of four hours.

Issued: May 10, 2011

Effective: July 1, 2011

By Kenneth Mason
Vice President
of Government and Regulatory Affairs

Applies to All Exchanges Illinois

FACILITIES FOR INTRASTATE ACCESS

6. MISCELLANEOUS SERVICES (Cont'd)

6.3 Maintenance of Service Charge (Cont'd)

- (B) The customer shall be responsible for payment of a Maintenance of Service Charge when the Telephone Company dispatches personnel to the customer's location and the trouble is in equipment or communications systems provided by other than the Telephone Company or in detariffed CPE provided by the Telephone Company.
- (C) The Maintenance of Service Charge time period will begin when Telephone Company personnel are dispatched. This will only include the actual time required to reach the customer's location and perform an investigation. The time period will end when the investigation is finished. The labor charge as set forth in 6.2 (G) preceding will apply to Maintenance of Service at the appropriate Basic, Overtime or Premium rate. These charges apply whether the trouble is in the equipment of communications systems provided by other than the Telephone Company, or in detariffed CPE provided by the Telephone Company.

* A call out of a Telephone Company employee at a time not consecutive with the business day is subject to a minimum charge of four hours.

Issued: May 10, 2011

Effective: July 1, 2011

By Kenneth Mason
Vice President
of Government and Regulatory Affairs

Applies to All Exchanges Illinois

FACILITIES FOR INTRASTATE ACCESS

6. MISCELLANEOUS SERVICES (Cont'd)

6.4 Telecommunications Service Priority (TSP) System

(A) Description of the Service

The TSP System is a service that provides for the priority provisioning and/or restoration of National Security Emergency Preparedness (NSEP) telecommunications services. The TSP System applies only to NSEP services, includes both Switched and Special FIA and provides the Telephone Company with a guide to the sequence in which services are to be provisioned and/or restored.

All FIA that can be identified by a unique circuit identifier can be provisioned for NSEP service by the Telephone Company.

The rates and charges associated with a customer subscribing to the TSP System are as specified in Section 6.4(G).

(B) Obtaining TSP System Service

The Executive Office of the President through the TSP Program Office, is empowered with the authority to receive, evaluate and process requests for NSEP services. The TSP Program Office makes the priority level assignments and issues the TSP authorization code reflecting the priority assignment associated with a request. The customer provides the TSP authorization code, in addition to all the other details necessary to complete the order (ASR) to the Telephone Company to obtain TSP System service.

The TSP authorization code, assigned on a per ASR basis, consists of a 12-character field consisting of a nine-character control ID followed by a dash and a two-character field specifying the priority level assignment. Its structure is as follows:

TSPxxxxxn-yy

The "x"s represent a sequence of numbers unique to each TSP authorization code and the "n" is a one character alphanumeric check digit. The first "y" contains the provisioning priority level assignment and the second "y" contains the restoration priority level assignment.

Applies to All Exchanges Illinois

FACILITIES FOR INTRASTATE ACCESS

6. MISCELLANEOUS SERVICES (Cont'd)

6.4 Telecommunications Service Priority (TSP) System (Cont'd)

(C) Provisioning Priority

If the customer requires service within a shorter time interval than the Telephone Company can provide, and the requested service qualifies for NSEP, the customer may elect to invoke NSEP Treatment and obtain the appropriate provisioning priority assignment from the TSP Program Office. Acceptable assignment code values are: E, 1, 2, 3, 4, 5 or 0.

The assignment of the value "E" denotes Emergency Provisioning and implies the service has the most critical provisioning requirements and the Telephone Company will respond accordingly. The Telephone Company will take immediate action to provide the requested service at the earliest possible date. Rates and charges associated with "E" provisioning are as specified in Section 6.4(G)(2)(a).

The assignment values of 1, 2, 3, 4 and 5 are treated as essential service priorities and the Company will adjust its available resources to meet the customer's requested due date. Rates and charges associated with invoking this priority treatment are specified in Section 6.4(G)(2)(b). The value "0" implies no provisioning priority.

(D) Restoration Priority

A TSP authorization code for restoration priority classifies the service as being among the nation's most important NSEP telecommunications services. The Company will restore these services before services without restoration priority assignments in the order of priority assignments. Acceptable values are: 1, 2, 3, 4, 5 or 0 with the value "1" being the highest priority.

When the Company recognizes a TSP as being out of service, unusable or receives a trouble report, available resources will be dispatched to restore the service as quickly as practicable. A priority value of 1, 2 or 3 requires dispatch outside normal business hours if necessary to restore the service. A priority value of 4 or 5 only requires dispatch outside of normal business hours if the next business day is more than 24 hours away. If the value "0" has been assigned, then no restoration priority is applicable to this service.

The minimum period of service is one month.

Applies to All Exchanges Illinois

FACILITIES FOR INTRASTATE ACCESS

6. MISCELLANEOUS SERVICES (Cont'd)

6.4 Telecommunications Service Priority (TSP) System (Cont'd)

(E) Obligations of the Customer

- (1) In all instances, the customer is responsible for obtaining the appropriate TSP authorization code and providing that code to the Telephone Company.
- (2) The TSP System service customer must also be the customer for the FIA with which TSP service is associated. Only the customer or its authorized agent as indicated in a letter of agency on file with the Telephone Company is allowed to order TSP System service.
- (3) All points of a multipoint service configuration must have the same restoration priority assignment and must satisfy the requirements of that assignment.
- (4) In obtaining TSP System service, the customer consents to the release of certain information by the Telephone Company to the federal government in order to maintain and administer the TSP System. Such information includes: the customer's name, telephone number and mailing address, the TSP authorization code and the circuit or service ID number associated with the NSEP service.
- (5) The Telephone Company will attempt to notify the customer of expected charges. The customer when invoking NSEP treatment, recognizes that quoting charges and obtaining permission beforehand may not be practicable and may cause unnecessary delays and, as a result, grants the Telephone Company the right to quote and bill charges after provisioning of the service.
- (6) During certain emergencies, the customer may request TSP assignments verbally and the Telephone Company will accept such verbal notification. The customer must submit a written order (ASR) to the Telephone Company within two working days following the verbal request. If the written order (ASR) is not received within two working days, all applicable rates and charges accumulated to date to provision TSP System service, become immediately due and payable and the requested TSP priority is revoked.

Applies to All Exchanges Illinois

FACILITIES FOR INTRASTATE ACCESS

6. MISCELLANEOUS SERVICES (Cont'd)

6.4 Telecommunications Service Priority (TSP) System (Cont'd)

(E) Obligations of the Customer (Cont'd)

- (7) The customer must request and justify revalidation of all priority level assignments at least every three years.
- (8) Additionally, the NCS Manual 3-1-1, "Telecommunications Service Priority (TSP) System for National Security Emergency Preparedness (NSEP) Service User Manual", dated July 9, 1990, prescribes specific conditions which warrant NSEP Treatment and related procedures.

(F) Obligations of the Telephone Company

- (1) The Telephone Company will allocate resources to ensure best efforts to provide NSEP services by the time required.
- (2) The Telephone Company will work TSP System services in the order of their priority level assignments. The priority sequence is as follows:
 - Restore NSEP services assigned restoration priority 1
 - Provision Emergency (E) NSEP services
 - Restore NSEP services assigned restoration priority 2, 3, 4 or 5
 - Provision NSEP services assigned provisioning priority 1, 2, 3, 4 or 5
- (3) The Telephone Company will work cooperatively with other providers of NSEP service when only a portion is provided by the Telephone Company to ensure "end-to-end" service.
- (4) Additionally, TSP System service will be provided in accordance with the guidelines set forth in NCS Handbook 3-1-2, "Telecommunications Service Priority (TSP) System for National Security Emergency Preparedness (NSEP) Service Vendor Handbook" dated July 9, 1990.

Applies to All Exchanges Illinois

FACILITIES FOR INTRASTATE ACCESS

6. MISCELLANEOUS SERVICES (Cont'd)

6.4 Telecommunications Service Priority (TSP) System (Cont'd)

(G) Rates and Charges

The following rates and charges are in addition to all other rates and charges that may apply for other services offered under this tariff which operate in conjunction with the TSP System.

(1) Establishment of TSP System Service

The establishment of TSP System service charge is a nonrecurring charge (NRC) specified in Section 6.4(G)(4) which applies when a FIA is ordered with provisioning and/or restoration priority. If both are ordered at the same time, only one NRC is applicable. The NRC is also applicable for orders changing priority levels.

(2) Provisioning Priority

There are two basic levels of priority provisioning, Emergency (provisioning priority "E") and Essential (provisioning priority 1, 2, 3, 4 or 5).

(a) Emergency Provisioning

The Telephone Company will take immediate action to provide the requested service at the earliest possible date. The rates and charges will apply as set forth in Section 10, Special Construction.

(b) Essential Provisioning

The Telephone Company will adjust its available resources to meet the customer's requested due date. The rates and charges will apply as set forth in Section 3.2.2(E).

Applies to All Exchanges Illinois

 FACILITIES FOR INTRASTATE ACCESS
6. MISCELLANEOUS SERVICES (Cont'd)6.4 Telecommunications Service Priority (TSP) System (Cont'd)(G) Rates and Charges (Cont'd)(3) Restoration Priority

Restoration Priority is a monthly rate per circuit for the ongoing administration and maintenance of the TSP System. This monthly rate only applies when a restoration priority code (1, 2, 3, 4 or 5) is specified in position 12 of the authorization code. The rates are specified in Section 6.4(G)(5).

(4) Establishment of TSP System Service Charge

Nonrecurring Charge, per Circuit	\$ 14.50
----------------------------------	----------

(5) Restoration Priority Rates

Monthly Rate, per Circuit	4.90
---------------------------	------

Applies to All Exchanges Illinois

FACILITIES FOR INTRASTATE ACCESS

6. MISCELLANEOUS SERVICES (Cont'd)

6.5 Balloting and Allocation Process For Equal Access

(A) IPIC Charge Application

In end offices converted to Equal Access, new end users, end user agents and resellers of Pay Telephones and multi-party end users who upgrade to individual lines must presubscribe to the IPIC of their choice at the time an order is placed for service. The IPIC may be an IC or LEC (the Telephone Company or another LEC). Upon the end user, end user agent or reseller's selection of the IPIC, at the time of placing an order, a confirmation notice will be sent identifying the IC or LEC selected as the IPIC. From the date of the confirmation notice, he will have 90 days to change his presubscription selection without a charge, on a one time basis. If an IPIC is not chosen at the time the order for service is submitted, the end user, end user agent or reseller will be sent a confirmation notice which contains a list of ICs and LECs providing intraMSA service, and will be informed that they have 90 days to contact the IC and/or LEC of their choice or the Telephone Company to apply for the IPIC arrangement. If notice is received by the Telephone Company within 90 days of the in-service date for local service or upgrade, no charge will be billed to the end user, end user agent or reseller. If notice is received after 90 days, the end user, end user agent or reseller will be billed a nonrecurring charge for each IPIC as in 6.5(E). Until the end user, end user agent or reseller receives service from the selected carrier, he may access the carrier of his choice by dialing the appropriate 101XXXX carrier identification code.

The Telephone Company will make post conversion changes in the end user end user agent or reseller's IPIC assignment pursuant to an IC or LEC provided list of Customers. Should an end user, end user agent or reseller dispute authorization of the change within two years of the IPIC assignment, the Telephone Company will place the end user on the previous carrier network where possible and the carrier will be billed according.

Issued: May 10, 2011

Effective: July 1, 2011

By Kenneth Mason
Vice President
of Government and Regulatory Affairs

Applies to All Exchanges Illinois

FACILITIES FOR INTRASTATE ACCESS

6. MISCELLANEOUS SERVICES (Cont'd)

6.5 Balloting and Allocation Process For Equal Access (Conti'd)

(B) Unauthorized Primary IntraMSA Carrier (IPIC) Restoral Change

An Unauthorized IPIC Change is a change in the preferred IPIC IC that the end user or Pay Telephone Service Provider denies authorizing.

If an end user or Pay Telephone Service Provider denies requesting a change in IPIC IC as submitted by the alleged unauthorized IC, the alleged unauthorized IC will be assessed the IPIC Charge as specified in 6.5(E) for:

- Changing the end user or Pay Telephone Service Provider to the disputed IC, and
- Placing the end user or Pay Telephone Service Provider on their previous IC network or the IC network of their choice.

In accordance with the Federal Communications Commission's Slamming Liability Rules in CC Docket 94-129, if an alleged unauthorized carrier is ultimately exonerated of liability, the alleged unauthorized IC is entitled to receive full payment from the end user or Pay Telephone Service Provider for all services provided. In such situations, any IPIC Charges assessed against the alleged unauthorized IC by the Telephone Company are subject to rebilling to the end user or Pay Telephone Service Provider by the alleged unauthorized IC.

Issued: May 10, 2011

Effective: July 1, 2011

By Kenneth Mason
Vice President
of Government and Regulatory Affairs

Applies to All Exchanges Illinois

FACILITIES FOR INTRASTATE ACCESS

6. MISCELLANEOUS SERVICES (Cont'd)

6.5 Balloting and Allocation Process For Equal Access (Cont'd)

(C) Liability of the Telephone Company

If through the fault of the Telephone Company, the end user, end user agent or reseller is not subscribed to its chosen IPIC, the nonrecurring charges in 6.5(E) do not apply to reassign the end user, end user agent or reseller to his chosen IPIC.

(D) Carrier Desired Due Date (ICDDD) for IPIC Installation

An IC or LEC may request a desired due date for IPIC installation for a specific, single end user, end user agent or reseller acting on behalf of an end user post equal access conversion. This ICDDD is a mutually agreed upon negotiated due date, determined to be between 3 and 45 business days from the date of receipt of the order. The carrier must coordinate the ICDDD with the Telephone Company prior to sending in the first order.

The Nonrecurring Charge for IPIC as set forth in 6.5(E), applies to each line converted to the carrier requesting ICDDD. This charge will be billed to the carrier's end user Customer.

(E) Nonrecurring Charge for Primary IntraMSA Carrier (IPIC)

The nonrecurring charge for IPIC is as follows:

	<u>Nonrecurring Charge</u>
Per Telephone Company	
Local Service Line or Trunk	\$ 3.86

Issued: May 10, 2011

Effective: July 1, 2011

By Kenneth Mason
Vice President
of Government and Regulatory Affairs

Applies to All Exchanges Illinois

FACILITIES FOR INTRASTATE ACCESS

6. MISCELLANEOUS SERVICES (Cont'd)

6.5 Balloting and Allocation Process For Equal Access (Cont'd)

(F) IC CIC Consolidation

IC requests to consolidate multiple CICs (Carrier Identification Codes) will be subject to an IC CIC Consolidation Charge. This charge is only assessed when all lines or trunks associated with the former CIC(s) are changed on a one-time realignment basis within the Telephone Company's databases at a nationwide level to a single existing CIC. Requests for an IC CIC Consolidation must be provided to the Telephone Company in writing, but no ASR charge is applicable for this request. The rate for this service is provided in 6.5(G).

The IC CIC Consolidation charge does not apply to normal PIC change activity, whereby carrier selection is changed and no consolidation of CICs occurs.

The Telephone Company will negotiate a due date for an IC CIC Consolidation with the IC. It is the sole responsibility of the IC to notify affected end users of the change.

If an IC elects to change a CIC due to surrendering a CIC to the North American Numbering Plan Administrator for reassignment, the IC CIC Consolidation Charge will be waived. The waiver is applied only when the IC surrenders the CIC on a nationwide basis. Additionally, the CIC must be relinquished within ninety (90) days from the completed conversion date. Confirmation of relinquished code(s) must be in writing and come from the NANP Administrator.

(G) Nonrecurring Charge for IC CIC Consolidation

	<u>Nonrecurring Charge</u>
IC CIC Consolidation Charge, per line or trunk	\$1.30

Note: This charge is billed to an IC who requests customer CIC changes in order to consolidate multiple CICs provided that all lines or trunks associated with the former CIC(s) are changed at the same time to a single existing CIC.

Applies to All Exchanges Illinois

FACILITIES FOR INTRASTATE ACCESS

6. MISCELLANEOUS SERVICES (Cont'd)

6.6 Additional Testing

The Telephone Company will perform acceptance testing as specified in 4.2.7 and 5.1.5 preceding to insure that FIA ordered by the customer are functioning properly, prior to turning over such FIA to the customer. In addition, the Telephone Company will perform ongoing tests as specified in 4.2.1 and 4.2.2 preceding to assure the continued satisfactory performance of Switched Access Services ordered by the customer.

Testing offered under this section of the tariff is in addition to those tests described above and will be provided, when requested by the customer, at an additional charge.

Testing is provided by Telephone Company personnel at Telephone Company locations. However, provisions are made in 6.6(A)(5) and 6.6(B)(2) following, to allow a customer to request Telephone Company personnel to perform testing at the customer designated location or the end user premises.

Additional testing is provided on a scheduled or nonscheduled basis. Scheduled testing shall be performed on a predetermined time basis to allow for cost efficient utilization of Telephone Company and customer resources. Scheduled testing should be based on a one year period. Nonscheduled tests are performed by the Telephone Company on a request-by-request basis, not in conjunction with any fixed schedule.

The offering of testing under this section of the tariff is made subject to the availability of the necessary qualified personnel and test equipment at the various test locations mentioned in (A), (B), and (C) following.

Issued: May 10, 2011

Effective: July 1, 2011

By Kenneth Mason
Vice President
of Government and Regulatory Affairs

Applies to All Exchanges Illinois

FACILITIES FOR INTRASTATE ACCESS

6. MISCELLANEOUS SERVICES (Cont'd)

6.6 Additional Testing (Cont'd)

(A) Switched Access Testing

Testing for Switched Access is comprised of (a) tests which are performed during the installation of Switched Access (i.e., acceptance tests) and (b) tests which are performed after acceptance of such Switched Access by a customer (i.e., in-service tests).

These tests are performed on a scheduled or nonscheduled basis, and may be conducted on an automatic, cooperative, or manual basis, as defined in (1), (2), (3), (4), and (5) following.

(1) Additional Cooperative Acceptance Testing

Additional Cooperative Acceptance Testing (ACAT) of Switched Access involves the Telephone Company provision of a technician at its office(s) and the customer provision of a technician at its CDL, with suitable test equipment to perform the required tests.

Additional Cooperative Acceptance Testing may apply when the customer requests additional tests not specified in 4.2.7. The labor charges as set forth in 6.2(G) will apply to Additional Cooperative Acceptance Testing at the appropriate Basic, Overtime, or Premium rate.

(2) Automatic Scheduled Testing

Automatic Scheduled Testing (AST) of FGB, FGC, FGD, BSA-B, BSA-C, BSA-D and SAC Access Service, is provided, as specified in 4.2.1 and 4.2.2, where the customer provides remote office test lines and 105 test lines with associated responders or their functional equivalent. AST charges will apply when such testing is requested on a more frequent basis than is provided for in accordance with the Telephone Company's Central Office Maintenance Planning System (COMPS). The customer may specify a more frequent schedule of tests at least sixty days prior to the start of the prescribed schedule. Trunks from a Telephone Company digital switch, to a customer digital switch, utilizing digital facilities, are excluded from mandatory routine testing. The rates, as set forth in 6.6(C)(1), will apply to additional AST.

Applies to All Exchanges Illinois

FACILITIES FOR INTRASTATE ACCESS

6. MISCELLANEOUS SERVICES (Cont'd)

6.6 Additional Testing (Cont'd)

(A) Switched Access Testing (Cont'd)

(2) Automatic Scheduled Testing (Cont'd)

The Telephone Company will provide a monthly AST report that lists the trunks within each Central Office access group that failed to meet established requirements. Trunk test failures requiring customer participation for trouble resolution will be provided to the customer on an as-occurs basis. A monthly report that lists the test results will be provided to the customer.

(3) Additional Cooperative Scheduled Testing

Additional Cooperative Scheduled Testing (ACST) of FGA, FGB, FGC, FGD, BSA-A, BSA-B, BSA-C, BSA-D and SAC Access Service occurs when the Telephone Company provides a technician at its office(s) and the customer provides a technician at its customer designated location, with suitable test equipment to perform the required tests. ACST charges will apply when loss/noise/balance testing or gain-slope testing is requested on a more frequent basis than is provided for in accordance with the Telephone Company's Central Office Maintenance Planning System (COMPS). ACST charges also apply when additional tests are requested for FGA, FGB, FGC, FGD, BSA-A, BSA-B, BSA-C, BSA-D and SAC Access Service that are not specified in 4.2.1 and 4.2.2 respectively. The customer may specify a more frequent schedule of tests sixty days prior to the start of the prescribed schedule. The rates, as set forth in 6.6(C)(2), will apply for additional ACST.

The Telephone Company will provide, on a quarterly basis, an ACST report that lists the test results and the number of trunks that passed or failed. Trunk test failures requiring customer participation for trouble resolution will be provided to the customer on an as-occurs basis.

Applies to All Exchanges Illinois

FACILITIES FOR INTRASTATE ACCESS

6. MISCELLANEOUS SERVICES (Cont'd)6.6 Additional Testing (Cont'd)(A) Switched Access Testing (Cont'd)(4) Additional Manual Scheduled Testing

Additional Manual Scheduled Testing (AMST) of FGA, FGB, FGC, FGD, BSA-A, BSA-B, BSA-C, BSA-D or SAC Access Service occurs when the Telephone Company provides a technician at its office(s) and at the customer designated location. AMST charges will apply when loss/noise/balance testing or gain-slope testing is requested on a more frequent basis than is provided for in accordance with the Telephone Company's Central Office Maintenance Planning System (COMPS). AMST charges also apply when additional tests are requested for FGA, FGB, FGC, FGD, BSA- A, BSA-B, BSA-C, BSA-D or SAC Access Service that are not specified in 4.2.1 and 4.2.2 respectively. The customer may specify a more frequent schedule of tests sixty days prior to the start of the prescribed schedule. The rates as set forth in 6.6(C)(3) following will apply to additional AMST.

The Telephone Company will provide, on a quarterly basis, an AMST report that lists the test results and the number of trunks that passed or failed. Trunk test failures requiring customer participation for trouble resolution will be provided to the customer on an as-occurs basis.

(5) Nonscheduled Testing

Nonscheduled Testing (NST) will be performed "on demand" which results in the measurement of Switched Access. NST charges will apply only when testing is requested more frequently than is provided for in accordance with COMPS, or when a specific test is requested that is not normally performed. Tests for Switched Access which are normally performed are contained in 4.2.1 and 4.2.2. Nonscheduled Testing (NST) of Switched Access may consist of the following testing arrangements:

Applies to All Exchanges Illinois

FACILITIES FOR INTRASTATE ACCESS

6. MISCELLANEOUS SERVICES (Cont'd)

6.6 Additional Testing (Cont'd)

(A) Switched Access Testing (Cont'd)

(5) Nonscheduled Testing (Cont'd)

- the customer provides remote office test lines and 105 test lines with associated responders or their functional equivalent , or
- the Telephone Company provides a technician at its office(s) and the customer provides a technician at its customer designated location with suitable test equipment to perform the required tests, or
- the Telephone Company provides a technician at its office(s), and at the customer designated location or end user premises with suitable test equipment to perform the required test.

Nonscheduled Tests may consist of any tests which the customer may require. The rates as set forth in 6.6(C)(1) following will apply to Nonscheduled Automatic Testing. The labor charges as set forth in 6.2(G) preceding will apply to Nonscheduled Cooperative and Manual FIA Testing at the appropriate Basic, Overtime, or Premium rate.

If nonscheduled tests are required and trouble is found in Telephone Company facilities, charges for testing the Telephone Company facilities will not apply. If, however, trouble is found in the customer equipment, charges as set forth in 6.6(C)(1) following and labor charges as set forth in 6.2(G) preceding are applicable.

Applies to All Exchanges Illinois

FACILITIES FOR INTRASTATE ACCESS

6. MISCELLANEOUS SERVICES (Cont'd)

6.6 Additional Testing (Cont'd)

(A) Switched Access Testing (Cont'd)

(6) Obligations of the Customer

- (a) The customer shall provide the Remote Office Test Line priming data to the Telephone Company, as appropriate, to support AST as set forth in 6.6(A)(2) preceding or NST as set forth in 6.6(A)(5) preceding.
- (b) The customer shall make the facilities to be tested available to the Telephone Company at times mutually agreed upon.

(B) Special Access Testing

The Telephone Company will, at the request of a customer, provide assistance in performing specific tests requested by the customer, however, the Telephone Company will only perform maintenance testing for its facilities within the MSA.

(1) Additional Cooperative Acceptance Testing

When a customer provides a technician at its customer designated location or at the end user premises, with suitable test equipment to perform the required tests, the Telephone Company will provide a technician at its office for the purpose of conducting Additional Cooperative Acceptance Testing (ACAT). The labor charges as set forth in 6.2(G) preceding will apply to ACAT at the appropriate Basic, Overtime, or Premium rate.

Additional Cooperative Acceptance Testing charges will apply when the customer requests tests which are not required to meet the transmission performance parameters as set forth in the Technical Interface Reference Manual.

Applies to All Exchanges Illinois

FACILITIES FOR INTRASTATE ACCESS

6. MISCELLANEOUS SERVICES (Cont'd)

6.6 Additional Testing (Cont'd)

(B) Special Access Testing (Cont'd)

(2) Nonscheduled Testing

When a customer provides a technician at its customer designated location or at the end user premises, with suitable test equipment to perform the required tests, the Telephone Company will provide a technician at its office (cooperative testing) for the purpose of conducting Nonscheduled Testing (NST). Nonscheduled testing may consist of any test (e.g., loss, noise, slope, envelope delay, etc.) which the customer may request. If such testing indicates trouble in Telephone Company facilities, then the customer will not be charged. NST charges will apply if the trouble is in the facilities of the customer. At the customer's request, the Telephone Company will provide a technician at the customer designated location or at the end user premises (manual testing). The labor charges as set forth in 6.2(G) preceding will apply to Nonscheduled Testing at the appropriate Basic, Overtime, or Premium rate.

(3) Obligation of the Customer

When the customer subscribes to Testing as set forth in this section, the customer shall make the facilities to be tested available to the Telephone Company at times mutually agreed upon.

Applies to All Exchanges Illinois

FACILITIES FOR INTRASTATE ACCESS

6. MISCELLANEOUS SERVICES (Cont'd)

6.6 Additional Testing (Cont'd)

(C) Rates and Charges

	<u>Per Month</u>
(1) Automatic Scheduled Testing	
Basic Offering to First Point of Switching, Per Transmission Path.....	\$.45
(2) Additional Cooperative Scheduled Testing	
(a) Basic Offering to First Point of Switching, Per Transmission Path	1.48
(b) Gain-Slope-To First Point of Switching, Per Transmission Path63
(3) Additional Manual Scheduled Testing	
(a) Basic Offering to First Point of Switching, Per Transmission Path	2.97
(b) Gain-Slope-To First Point of Switching, Per Transmission Path	1.26

Issued: May 10, 2011

Effective: July 1, 2011

By Kenneth Mason
 Vice President
 of Government and Regulatory Affairs

Applies to All Exchanges Illinois

FACILITIES FOR INTRASTATE ACCESS

6. MISCELLANEOUS SERVICES (Cont'd)

6.7 End User/Agent Lists

(A) Presubscription List

(1) InterMSA Equal Access

Prior to conversion to equal access (i.e., introduction of FGD or BSA-D in an end office switch) an IC may request a list of the Telephone Company's end users and agents of record served from that end office switch. The Presubscription List will be provided as follows:

- (a) The Telephone Company will provide a list from its customer data base. The list may be provided on magnetic tape, electronic transmission or paper printout, at the option of the IC, at rates provided in 6.8.1(A). Foreign listings, PBX stations, CU centrex stations and numbers not in service will not be provided.
- (1) The Initial List will be provided to the IC no later than 30 days after receipt of the order and payment by the IC of charges in 6.8.1(A). The nonrecurring charge for the Initial List applies per order. A single order may contain all end offices having the same equal access conversion date. The telephone number will not be provided if an end user or agent has a nonpublished number.
- (2) The Account Activity List, which includes a listing of all changes to the customer data base, since the Initial List was produced, will be provided on a cyclic basis. The Account Activity List will only include information for those end users and agents that are presubscribed to the IC (including end users and agents with nonpublished numbers) for the sole purpose of updating the IC's customer account information. There is no charge for this list.
- (b) The IC agrees to use the Initial and Account Activity Lists for the sole purpose of contacting potential customers/agents, or existing customers/agents, regarding interexchange telecommunications services available through equal access to be obtained from the Telephone Company or for the purpose of updating IC customer/ agent account information. The IC agrees not to sell, or reproduce in any manner, in whole or in part, the lists or permit such to be done.

Applies to All Exchanges Illinois

FACILITIES FOR INTRASTATE ACCESS

6. MISCELLANEOUS SERVICES (Cont'd)

6.7 End User/Agent Lists (Cont'd)

(A) Presubscription List (Cont'd)

(1) InterMSA Equal Access (Cont'd)

- (c) The IC shall indemnify, protect and save harmless the Telephone Company from and against any and all loss, liability, damages and expense arising out of any demand, claim, suit or judgment for damages which may arise out of the Telephone Company's supplying of listing information, services or records.
- (d) The Telephone Company and the IC agree that the mutual objective of the parties is to conduct their respective businesses to avoid confusion by the end users and agents as to the separate and independent identity of the respective companies and their services. Neither the Telephone Company nor the IC shall make any representation to end users, the public, prospective advertisers, expressed or implied, written or oral, which would imply that the IC is the same as, a part of, or associated with the Telephone Company.
- (e) This service may be terminated by either the Telephone Company or the IC upon thirty (30) days' written notice or as specified in 2.1.8. The Telephone Company reserves the right to terminate this service immediately upon written notice if the IC misuses the list information. Performance by the Telephone Company shall be excused in the event of strike, riot, act of God or any other cause beyond the reasonable control of the Telephone Company.

Applies to All Exchanges Illinois

FACILITIES FOR INTRASTATE ACCESS

6. MISCELLANEOUS SERVICES (Cont'd)6.7 End User/Agent Lists (Cont'd)(A) Presubscription List (Cont'd)(2) IntraMSA Equal Access

Prior to conversion to intraMSA equal access an IC or LEC may request a list of the Telephone Company's end users of record served from that end office switch. A single Presubscription List will be provided to intraMSA toll providers as follows:

- (a) The Telephone Company will provide a list from its customer data base. The list may be provided on magnetic tape, electronic transmission or paper printout, at the option of the IC or LEC, at rates provided in 6.8.1(A). Foreign listings, PBX stations, CU centrex stations, public coin station and numbers not in service will not be provided.
- (1) The Initial List will be provided to the IC or LEC no later than 30 days after receipt of the order and payment by the IC or LEC of charges in 6.8.1(A). The nonrecurring charge for the Initial List applies per order. A single order may contain all end offices having the same intraMSA equal access conversion date. The telephone number will not be provided if an end user has a nonpublished number.
- (2) The Account Activity List, which includes a listing of all changes to the customer data base, since the Initial List was produced, will be provided on a cyclic basis. The Account Activity List will only include information for those end users that are presubscribed to the IC or LEC (including end users with nonpublished numbers) for the sole purpose of updating the IC's or LEC's customer account information. There is no charge for this list.
- (b) The IC or LEC agrees to use the Initial List for the sole purpose of contacting potential customers, or existing customers, regarding intraMSA telecommunications services available through equal access to be obtained from the Telephone Company. The IC or LEC agrees not to sell, or reproduce in any manner, in whole or in part, the lists or permit such to be done.

Applies to All Exchanges Illinois

FACILITIES FOR INTRASTATE ACCESS

6. MISCELLANEOUS SERVICES (Cont'd)

6.7 End User/Agent Lists (Cont'd)

(A) Presubscription List (Cont'd)

(2) IntraMSA Equal Access (Cont'd)

- (c) The IC or LEC shall indemnify, protect and save harmless the Telephone Company from and against any and all loss, liability, damages and expense arising out of any demand, claim, suit or judgment for damages which may arise out of the Telephone Company's supplying of listing information, services or records.
- (d) The Telephone Company and the IC or LEC agree that the mutual objective of the parties is to conduct their respective businesses to avoid confusion by the end users as to the separate and independent identity of the respective companies and their services. Neither the Telephone Company nor the IC or LEC shall make any representation to end users, the public, prospective advertisers, expressed or implied, written or oral, which would imply that the IC or LEC is the same as, a part of, or associated with the Telephone Company.
- (e) This service may be terminated by either the Telephone Company or the IC or LEC upon thirty (30) days' written notice or as specified in 2.1.8. The Telephone Company reserves the right to terminate this service immediately upon written notice if the IC or LEC misuses the list information. Performance by the Telephone Company shall be excused in the event of strike, riot, act of God or any other cause beyond the reasonable control of the Telephone Company.

Applies to All Exchanges Illinois

FACILITIES FOR INTRASTATE ACCESS

6. MISCELLANEOUS SERVICES (Cont')

6.7 END USER/AGENT LISTS (Cont'd)

(B) Allocation Lists

- (1) The Telephone Company will provide to the IC, at no charge, a list of end users and agents that have been allocated to the IC as described in 6.5(B). This list will be provided after the Balloting and Allocation Process occurs.
- (2) A list of all end users and agents who have been allocated, in accordance with 6.5(B), will be available to an IC upon request. Charges in 6.8.1(A) will apply. The nonrecurring charge for the Allocation List applies each time the IC orders the service. A single ASR may contain all end offices having the same equal access conversion date.

(C) Snapshot List

The Snapshot List is a summary of selected end user and agent information for a specific IC or LEC which resides in the Telephone Company customer database. The Snapshot List may be provided on magnetic tape, electronic transmission, or paper printout, at the option of the IC or LEC, at rates provided in 6.7.1(B). Foreign listings, PBX stations, CU Centrex stations and numbers not in service will not be provided.

The Snapshot List will be provided to the IC or LEC no later than 30 days after receipt of the order. The nonrecurring charge for the Snapshot List applies per order.

The purpose, liability and objectives associated with the provision of the Snapshot List is 6.8(A)(1).

Applies to All Exchanges Illinois

FACILITIES FOR INTRASTATE ACCESS

6. MISCELLANEOUS SERVICES (Cont’)

6.7 END USER/AGENT LISTS (Cont’d)

(D) Line Range Reports – Lines Not Available for Subscription

The Line Range Report provides information to the IC regarding a line or series of lines (telephone numbers) that are not available for subscription. The lines may be in a central office that has not been converted to equal access or may have services/equipment which make them unavailable for subscription.

The Line Range Report can be provided on a monthly basis as requested by the customer. Each monthly report provided will incur a nonrecurring charge as set forth in 6.7.1(C).

6.7.1 Rates and Charges

	<u>Nonrecurring Charge Per Order</u>	<u>Initial List Per Customer Account*</u>	<u>Allocation List, Per Listing</u>
(A) <u>Initial and Allocation Lists</u>	\$ 50.00	\$.03	\$.03
			<u>Per Listing</u>
(B) <u>Snapshot Lists</u> **	75.00	.05	
(C) <u>Line Range Reports (NRBZR)</u>		583.00	

* For the purpose of the initial Lists a customer is defined in Section 2.6. For the purpose of the Allocation list, a listing is defined as an end user or agent record eligible for an InterMSA Primary Interexchange Carrier Selection.

** For the purpose of the Snapshot list, a listing is defined as and end user or agent recorded eligible for a Predesignated InterMSA and/or IntraMSA Interexchange Carrier Selection.

Applies to All Exchanges Illinois

FACILITIES FOR INTRASTATE ACCESS

6. MISCELLANEOUS SERVICES (Cont'd)

6.8 Billing Name and Address Service

The Telephone Company will, upon request, provide Billing Name and Address Services (BNAS) to a Telecommunications Service Provider (customer), or its authorized billing and collection agent. Telecommunications Service Providers include interexchange carriers, operator service providers, enhanced service providers, and any other provider of intrastate/interstate telecommunications services. There are three BNAS offerings available pursuant to this tariff: Per Call/Periodic BNA, Data Gathering Service (DGS) and End User Validation List.

(A) Per Call/Periodic BNA and Data Gathering Service

Per Call/Periodic BNA is the billing name and address information and Data Gathering is the billing telephone number, name, address and associated working telephone number information for customer provided ten digit end user telephone numbers required by the Telecommunications service provider customer to bill for calls placed within a specific time period. Per Call/Periodic BNA and DGS are offered subject to the following conditions:

- (1) A standard format for the receipt and provision of telephone number and billing name and address information will be established by the Telephone Company. Charges for each Per Call/Periodic BNA searched for and found or searched for and not found will be billed at rates in 6.8.1(A). Charges for each record accessed for DGS are set forth under 6.8.1(B). Per Call/Periodic BNA and DGS will be provided via magnetic tape, electronic transmission or paper format, at the option of the customer, at rates in 6.8.1. The processing fee will be applied in the state of Illinois, once per calendar year for BNAS processing done within that calendar year.
- (2) The customer must order Per Call/Periodic BNA or DGS and provide a test data tape at least 30 days prior to delivery of the first customer order.
- (3) The frequency for receipt of the customer provided orders for Per Call/Periodic BNA or DGS will be no more than twice monthly and at intervals mutually agreed upon between the Telephone Company and the customer. The customer provided end user telephone numbers will be programmed by the Telephone Company with the proper end user's billing name and address contained in the Telephone Company's file at that time.

Applies to All Exchanges Illinois

FACILITIES FOR INTRASTATE ACCESS

6. MISCELLANEOUS SERVICES (Cont'd)

6.8 Billing Name and Address Service (Cont'd)

(A) Per Call/Periodic BNA and Data Gathering Service (Cont'd)

- (4) Per Call/Periodic BNA and DGS information for nonlisted/nonpublished end user telephone numbers will be provided unless the nonlisted/nonpublished end user provides notice of nonconsent to the Telephone Company of nonconsent to the release of the BNA/DGS data. Within 30 days of receipt of such notice, the Telephone Company will discontinue disclosure of the end user's nonlisted/nonpublished BNA/DGS data.
- (5) For other than electronic transmission, the output records will be sent to the customer via first class U.S. Mail. The output records will normally be made available for mailing ten workdays after receipt of the customer order or at an interval mutually agreed upon. Availability may be delayed in case of input errors in the customer provided order.
- (6) The customer may request data be transmitted. Data transmission charges will be determined on an ICB. Data transmission hardware and software specifications will be mutually agreed upon by the Telephone Company and the customer.
- (7) Per Call/Periodic BNA and DGS detail will not be retained by the Telephone Company longer than 45 days. If the customer requests that the output be made available on a second occasion, such request must occur within 30 days from the date the first was made.
- (8) Any customer, provided Per Call/Periodic BNA or DGS pursuant to this tariff, agrees to abide by all applicable rules, decisions, orders, statutes and laws concerning the disclosure of published and nonpublished telephone numbers, and further agrees to use the information contained therein only for the purpose of billing for services provided to their end users.

Applies to All Exchanges Illinois

FACILITIES FOR INTRASTATE ACCESS

6. MISCELLANEOUS SERVICES (Cont'd)

6.8 Billing Name and Address Service (Cont'd)

(A) Per Call/Periodic BNA and Data Gathering Service (Cont'd)

- (9) In no case shall any customer or authorized billing and collection agent of a customer disclose the billing name and address information of any subscriber to any third party, except that a customer may disclose BNA/DGS information to its authorized billing and collection agent or to governmental law enforcement agencies.
- (10) Conditions regarding refusal or discontinuance of this service are set forth in 2.1.8.

(B) End User Validation List

End User Validation Lists provide for the disclosure of all or a portion of end user/agent data available from the Telephone Company's records, to a Telecommunications Service Provider (customer), for purposes other than billing, and in compliance with the conditions set forth in Part 64.120(c)(1) of the FCC's Rules and Regulations. In addition, End User Validation List Service is offered subject to the conditions set forth in 6.8(A)(9) above, and the following:

- (1) Standard End User Validation Lists will be provided in three (3) files, business, coin (semi-public and public paystations) and residence. Nonlisted/nonpublished information will be excluded, with the exception of nonlisted public paystations. The lists may be ordered for any of the Telephone Company's jurisdictions subject to this tariff, unless prohibited by federal regulation or federal statute. Rates for the standard End User Validation List are set forth under 6.8.1(C).
- (2) Per calendar year, the customer may request up to two (2) lists for business, coin, and residence listings.
- (3) A standard format will be established by the Telephone Company. Requests for special list sorts will be limited to an end user list separating those that are presubscribed to the requesting customer, and/or those that are not. The rate, per record, applicable to special sorts is set forth under 6.8.1(C).

Applies to All Exchanges Illinois

FACILITIES FOR INTRASTATE ACCESS

6. MISCELLANEOUS SERVICES (Cont'd)6.8 Billing Name and Address Service (Cont'd)(B) End User Validation List (Cont'd)

- (4) Each request shall be treated as a new request. Requests for updates from previous lists will not be provided.
- (5) The customer shall have fifteen (15) business days from the date of delivery of a list to request any investigation of issues arising from the provision of the list.
- (6) End User Validation Lists will normally be provided to the customer within thirty calendar days after receipt of a request and within ten (10) business days of extraction, or at an interval mutually agreed upon. The administrative fee set forth under 6.8.1(C) applies per request.
- (7) Conditions regarding refusal or discontinuance of this service are set forth in 2.1.8.

6.8.1 Rates and Charges(A) Per Call/Periodic BNA

Billing Name and Address Found/Each	\$.14
Billing Name and Address Not Found/Each	.14
Processing Fee*, Paper Report, Electronic Transmission or Magnetic Tape	50.00

(B) Data Gathering Service

Per Record Accessed	\$.18
Processing Fee*, Paper Report, Electronic Transmission or Magnetic Tape	75.00

*Applies once per calendar year for BNA processing done within that calendar year.

Issued: May 10, 2011

Effective: July 1, 2011

By Kenneth Mason
Vice President
of Government and Regulatory Affairs

Applies to All Exchanges Illinois

FACILITIES FOR INTRASTATE ACCESS

6. MISCELLANEOUS SERVICES (Cont'd)6.8 Billing Name and Address Service (Cont'd)6.8.1 Rates and Charges (Cont'd)(C) End User Validation List

Standard Sort, Per Record Provided	.034
Administrative Fee, Paper Report, Electronic Transmission or Magnetic Tape/Per request	78.00
Special Sort, Per Record Provided	.054

6.9 Denial/Restoral Service

The Telephone Company will, upon request, provide Denial/Restoral service to ICs for those end users that have designated the IC as their primary interexchange carrier. Conditions regarding refusal or discontinuance of Denial/Restoral service are set forth in 2.1.8.

- (A) Denial/Restoral service provides for Telephone Company notification to an IC that an end user's local exchange service has been temporarily suspended due to non-payment of the end user's local exchange service. Subsequently, the Telephone Company will provide notification to the IC if the end user's service has been restored from temporary suspension.
- (B) Notification shall be provided via the customer Account Record Exchange electronic interface.

*Applies once per calendar year for BNA processing done within that calendar year.

Issued: May 10, 2011

Effective: July 1, 2011

By Kenneth Mason
Vice President
of Government and Regulatory Affairs

Applies to All Exchanges Illinois

FACILITIES FOR INTRASTATE ACCESS

6. MISCELLANEOUS SERVICES (Cont'd)6.9 Denial/Restoral Service (Cont'd)

(C) The IC agrees to abide by all applicable rules, decisions, orders, statutes and laws concerning the disclosure of published and nonpublished telephone numbers, and further agrees to use the information provided by Denial/Restoral service only for the purposes of billing services provided to their end users.

(D) A charge in (E) will apply to the IC for each notification per end user local telephone exchange service number provided to the IC.

(E) Denial/Restoral Service
- per telephone number provided \$10

6.10 International Blocking Service

The Telephone Company, upon request, will provide end office blocking of only end user direct dialed 011+ and 101XXXX+011+ calls from an end user's location. This optional service is offered on a per line basis where facilities permit and is available for use with local business exchange service offered in the Telephone Company's local exchange tariff.

International Blocking Service, Per Line of Trunk	Nonrecurring Charge \$19.95
--	--------------------------------

6.11 Service Access Code 900 Blocking

Service Access Code 900 Blocking provides for the blocking of all calls originated to the 900 service access code. The service is provided upon request where facilities permit and is provided free of charge to customers for the first blocking request. For 900 blocking requests after the first request a nonrecurring charge is applicable per telephone number blocked. customer requests to remove 900 blocking (i.e. to unblock the service) must be in writing. There is no charge for unblocking.

Service Access Code 900 Blocking, Per Number Blocked after First Request	Nonrecurring Charge \$5.00
---	-------------------------------

Applies to All Exchanges Illinois

FACILITIES FOR INTRASTATE ACCESS

6. MISCELLANEOUS SERVICES (Cont'd)

6.12 Selective Class of Call Screening

(A) Selective Class of Call Screening is an optional service available, where facilities permit, in Telephone Company electronic end offices. This service restricts outgoing 1+, 0+ and 0- calls placed over the Telephone Company's network, to only those calls which are charged to a number other than the originating number, i.e., collect, third number billed or Calling Card. Selective Class of Call Screening is available for use with line side General Exchange Tariff services that are provided for the provision of telecommunication services to transient members of the public at the rates shown in 6.12 (B).

The customer will specify, at the time of the order, the restriction or restrictions desired. The customer may specify any combination of the following to restrict the billing of outgoing toll calls to:

- A Credit Card
- A Third Number
- Collect to the Called Number

Option 1

An outgoing 1+ call will not be permitted unless the end user makes arrangements to have the call billed to a called telephone number (Collect), a third number or a Calling Card account.

Option 2

An outgoing 0+ or 0- call will not be permitted unless the end user makes arrangements to have the call billed to a called telephone number (Collect), a third number or a Calling Card account.

(B) Rates and Charges

Monthly Rate, Per Screening Option \$0.30

Applies to All Exchanges Illinois

FACILITIES FOR INTRASTATE ACCESS

6. MISCELLANEOUS SERVICES (Cont'd)

6.13 Answer Supervision - BSE

Answer Supervision is the line side functionality that provides an electrical signal to the calling end of a switched telephone connection when the called line goes off-hook.

Monthly Rate, Per Line \$6.35

6.14 Reserved for Future Use

(D)

|

(D)

(T)

(D)

|

(D)

Applies to All Exchanges Illinois

FACILITIES FOR INTRASTATE ACCESS

6. MISCELLANEOUS SERVICES (Cont'd)

6.14 Reserved for Future Use

(T)

(D)

(D)

6.15 DS1 Span Power

When DS1 Service, provided over metallic facilities, is connected to customer provided optical high voltage protection, the Telephone Company will provide, upon request, DS1 span power from the CO to the CPE electrical-to-optical converter, at the point of termination.

	Monthly <u>Rate</u>	Nonrecurring <u>Charge</u>
Telephone Company provided DS1 Span Power	\$71.00	\$340.00

Applies to All Exchanges Illinois

FACILITIES FOR INTRASTATE ACCESS

7. SPECIALIZED FIA OR ARRANGEMENTS

7.1 General

Specialized FIA or arrangements may be provided by the Telephone Company, at the request of a customer, on an Individual Case Basis (ICB) if such FIA or arrangements meet the following criteria:

- The requested FIA or arrangements are not offered under other sections of this tariff.
- The facilities utilized to provide the requested FIA or arrangements are of a type normally used by the Telephone Company in furnishing its other services.
- The requested FIA or arrangements are provided within a Market Area.
- The requested FIA or arrangements are compatible with other Telephone Company services, facilities, and its engineering and maintenance practices.

This offering is subject to the availability of the necessary Telephone Company personnel and capital resources.

Issued: May 10, 2011

Effective: July 1, 2011

By Kenneth Mason
Vice President
of Government and Regulatory Affairs

Applies to All Exchanges Illinois

FACILITIES FOR INTRASTATE ACCESS

SECTION 8 TABLE OF CONTENTS

8. <u>ANCILLARY SERVICES</u>	<u>Page</u>
8.1 <u>Billing and Collection Services</u>	2
8.1.1 Service Offerings	2
8.1.2 Regulations	3
8.1.3 Description of Billing and Collection Services.....	10
8.1.4 Rate Regulations	22
8.1.5 Rates and Charges	27
8.2 <u>Directory Assistance Service</u>	29
8.2.1 General	29
8.2.2 Description of Service.....	29
8.2.3 Undertaking of the Telephone Company	30
8.2.4 Obligations of the Customer	30
8.2.5 Payment Arrangements	31
8.2.6 Rate Regulations	32
8.2.7 Rates and Charges	32
8.3 <u>Operator Services</u>	33
8.3.1 General Description	33
8.3.2 Service Provisioning	35
8.3.3 Rate Regulations	36
8.3.4 Rates and Charges	37

Applies to All Exchanges Illinois

FACILITIES FOR INTRASTATE ACCESS

8. ANCILLARY SERVICES

8.1 Billing and Collection Service

Ancillary Services consist of Billing and Collection Service, Directory Assistance and Operator Services. Ancillary Services shall be furnished to subscribers to the Telephone Company's access services and, in addition, other telecommunications service providers, including providers of telephone answering services or voice messaging services.

All subscribers of Ancillary Services are subject to the terms and conditions contained within this tariff. Should the customer choose to perform his own ancillary functions and require sufficient information to do so, listed customer information may be purchased consistent with Illinois state regulations governing any rights to privacy. Charges for such lists are as set forth in Section 6 of this tariff.

8.1.1 Service Offerings

Billing and Collection Services are available in the following categories:

- Call Recording Service
- Message Processing Service
- Assembly and Editing Service
- Call Record Provision Service
- Message Bill Processing Service
- Bill Rendering Service
- Message Investigation Service
- Online Bill Pay
- Fundamental Billing
- Program Development
- Inquiry Service

Regulations, rates and charges as follows apply to Billing and Collection Services and shall not serve as a substitute for customer tariff offerings of services to end users. The provision of such Billing and Collection Services by the Telephone Company, as set forth following, does not constitute a joint undertaking with the customer for the furnishing of any service.

The Telephone Company's undertaking to provide Billing and Collection Services is made only in conjunction with intrastate services offered within its operating territory.

The regulations, rates and charges contained herein are in addition to the applicable regulations, rates and charges specified in other sections of this tariff and in other tariffs of the Telephone Company which are referenced herein.

Applies to All Exchanges Illinois

FACILITIES FOR INTRASTATE ACCESS

8. ANCILLARY SERVICES (Cont'd)

8.1 Billing and Collection Service (Cont'd)

8.1.2 Regulations

(A) Undertaking of the Telephone Company

(1) Provision of Billing and Collection Services

- (a) The Telephone Company, to the extent Billing and Collection Services are, or can be made available with reasonable effort, will provide to the customer Billing and Collection Services as described in 8.1.3, at rates and charges as specified in 8.1.5.
- (b) When the customer subscribes to Call Recording Service, as set forth in 8.1.3(A), and customer message detail is not available because the Telephone Company lost or damaged tapes or incurred recording system outages, the Telephone Company will estimate the volume of lost customer messages and associated revenue based on previously known values determined from historical data. In such events the extent of the Telephone Company's liability for damages shall be limited to the granting of a corresponding credit adjustment on the customer's bill representing amounts due to the customer for the unbilled revenue.

When the Telephone Company is notified that, due to error or omission, incomplete data has been provided to a customer, the Telephone Company will make every reasonable effort to locate and/or recover the data and provide new magnetic tapes to the customer at no additional charge. Such request to recover the data must be made within 30 days from the date the details were initially made available to the customer. If the data cannot be recovered, the extent of the Telephone Company's liability for damages shall be limited as set forth in the preceding paragraph.

Applies to All Exchanges Illinois

FACILITIES FOR INTRASTATE ACCESS

8. ANCILLARY SERVICES (Cont'd)

8.1 Billing and Collection Service (Cont'd)

8.1.2 Regulations (Cont'd)

(A) Undertaking of the Telephone Company (Cont'd)

(1) Provision of Billing and Collection Services (Cont'd)

(c) The Telephone Company shall be responsible for contacts and arrangements with the end user concerning the billing, collecting, crediting and adjusting of the customer's service charges, when the Telephone Company provides Inquiry Service as set forth in 8.1.3(K).

(d) Message Bill Processing, Bill Rendering, Online Bill Pay, Fundamental Billing and Inquiry Services will only be offered by the Telephone Company with the purchase of receivables. The Telephone Company will purchase the customer's receivables at a discount from face value.

(2) Discontinuance and Refusal of Billing and Collection Services

(a) If the customer fails to comply with the provisions of this tariff, including any payments to be made by it on the dates or at the times herein specified, and fails within thirty (30) days after written notice via certified mail from the Telephone Company to an officer of the customer requesting payment for such noncompliance, the Telephone Company may discontinue the provision of the Billing and Collection Service. In case of such discontinuance, all applicable charges shall immediately become due.

(b) If the customer repeatedly fails to comply with the provisions of this tariff in connection with the provision of Billing and Collection Services and fails to correct such course of action after notice as set forth in (a) preceding, the Telephone Company may refuse applications for additional Billing and Collection Services.

Applies to All Exchanges Illinois

FACILITIES FOR INTRASTATE ACCESS

8. ANCILLARY SERVICES (Cont'd)

8.1 Billing and Collection Service (Cont'd)

8.1.2 Regulations (Cont'd)

(B) Obligations of the Customer

(1) References to the Telephone Company

The customer may advise end users that Billing and Collection Services are provided by the Telephone Company in connection with the service the customer furnishes to its end users.

(2) Request for Service

(a) Minimum Order Periods

The customer shall order Billing and Collection Service(s) with the following minimum requirements:

The minimum period for which Call Recording Service is provided and for which charges apply is one month (30 days). A customer may cancel Call Recording Service on any date prior to the start of the next month's service. If written notice is not received from the customer, or from the telephone company that ordered the Call Recording Service prior to the start of the following month's service, the Telephone Company shall assume that the service is to be extended for another month (30 days).

The initial minimum period for Message Processing, Message Bill Processing, Bill Rendering, Online Bill Pay, Fundamental Billing and Inquiry Services is three years. Six months prior to the end of the initial order period or subsequent extension, the customer shall notify the Telephone Company in writing, if the service is to be discontinued. If no notice is received from the customer, the Telephone Company shall assume that the service is extended for another year.

Applies to All Exchanges Illinois

FACILITIES FOR INTRASTATE ACCESS

8. ANCILLARY SERVICES (Cont'd)8.1 Billing and Collection Service (Cont'd)8.1.2 Regulations (Cont'd)(B) Obligations of the Customer (Cont'd)(2) Request for Service (Cont'd)(b) Order Requirements

When Call Recording Service is ordered, the customer shall furnish the Telephone Company an estimate of the number of messages (message capacity) to be recorded. When Call Recording Service is provided from an end office switch, the estimate of the number of messages to be recorded shall be provided by end office. When Call Recording Service is provided from an access tandem, the estimate of the number of messages to be recorded shall be provided by access tandem. The message capacity shall be provided by year.

When Message Processing Service is ordered, the customer shall furnish the Telephone Company an estimate of the number of messages (message capacity) to be processed. The number of messages shall be provided by year.

When Message Bill Processing, Message Investigation, Online Bill Pay, Fundamental Billing and Inquiry Services are ordered for MTS/WATS¹ services, the customer shall furnish the Telephone Company an estimate of the number of messages (message capacity) to be billed. The message capacity shall be provided by year. Separate estimates shall be furnished by the customer for MTS messages, bulk-billed messages (WATS¹/800 services) and Fundamental Billing Service messages. (C)

When Bill Rendering Service is ordered, the customer shall furnish the Telephone Company an estimate of the number of bills for which Bill Rendering Service will be provided. The bill capacity shall be provided by year. Separate estimates shall be furnished by the customer for MTS bills, bulk billed bills (WATS¹/800) and Fundamental Billing Service bills. (C)

¹ Wide Area Telecommunications Service (WATS) offering is grandfathered as of August 31, 2020 and limited to existing subscribers at their existing locations. (N)
(N)

Applies to All Exchanges Illinois

FACILITIES FOR INTRASTATE ACCESS

8. ANCILLARY SERVICES (Cont'd)

8.1 Billing and Collection Service (Cont'd)

8.1.2 Regulations (Cont'd)

(C) Payment Arrangements

(1) Minimum Charges

(a) Call Recording, Message Processing, Message Bill Processing, Online Bill Pay, Bulk-Billed, Fundamental Billing and Inquiry Services are subject to minimum charges.

(b) Any minimum billings associated with the above services will be filed on an individual case basis in Section 8.1.5 of this tariff.

(2) Cancellation of Order for Billing and Collection Services

(a) When an order for Billing and Collection Services is cancelled prior to the start of installation of such services, no charges will apply. Installation of Billing and Collection Services is considered to have started when the Telephone Company incurs any cost in connection therewith or in preparation thereof which would not otherwise have been incurred.

Applies to All Exchanges Illinois

FACILITIES FOR INTRASTATE ACCESS

8. ANCILLARY SERVICES (Cont'd)

8.1 Billing and Collection Service (Cont'd)

8.1.2 Regulations (Cont'd)

(C) Payment Arrangements (Cont'd)

(2) Cancellation of Order for Billing and Collection Services (Cont'd)

(b) Where program development of Billing and Collection Services has been started prior to the cancellation, and to the extent the Telephone Company has another use for the specially developed Billing and Collection Services, no charge applies. When the Telephone Company has no other use for the specially developed Billing and Collection Services, a charge equal to the costs incurred prior to the date of cancellation applies. Such charge is determined as detailed in paragraph (c).

(c) The charge, as specified in paragraph (b) includes the cost, less the net salvage value of equipment and material either ordered, provided or installed, plus the nonrecoverable cost of system development and installation. Charges will be determined on an individual case basis as required and will be specified in 8.1.5(M).

(3) Acceptance of Gift Certificates

The Telephone Company will accept customer gift certificates for payment from end users, if the customer agrees in writing to redeem all such gift certificates.

(4) Minimum Period Disconnect Charges

Minimum period disconnect charges will apply, if service is discontinued prior to the expiration of the minimum period. For Call Recording Service, the Telephone Company will use the most recent 30 day period for which data is available to determine the total minimum monthly charge. The customer will only be billed for the adjusted amount due, if payment has been received for any portion of the discontinued service.

Applies to All Exchanges Illinois

FACILITIES FOR INTRASTATE ACCESS

8. ANCILLARY SERVICES (Cont'd)

8.1 Billing and Collection Service (Cont'd)

8.1.2 Regulations (Cont'd)

(C) Payment Arrangements (Cont'd)

(4) Minimum Period Disconnect Charges (Cont'd)

If, for Message Processing, Message Bill Processing, Bill Rendering, Online Bill Pay, Fundamental Billing and Inquiry Services, service is discontinued prior to the end of the period ordered, the customer will pay the minimum charges for the remaining months of the minimum order period specified in 8.1.2(B)(2)(a).

The monthly charge for Message Processing, Message Bill Processing, Bill Rendering, Online Bill Pay, Fundamental Billing and Inquiry Services will be one-twelfth of the appropriate yearly message capacity (i.e., MTS service billed or bulk-billed capacity estimate) furnished by the customer as set forth above, times the appropriate Message Processing, Message Bill Processing, Bill Rendering, Online Bill Pay, Fundamental Billing and Inquiry Services rate.

Issued: May 10, 2011

Effective: July 1, 2011

By Kenneth Mason
Vice President
of Government and Regulatory Affairs

Applies to All Exchanges Illinois

FACILITIES FOR INTRASTATE ACCESS

8. ANCILLARY SERVICES (Cont'd)

8.1 Billing and Collection Service (Cont'd)

8.1.2 Regulations (Cont'd)

(C) Payment Arrangements (Cont'd)

(5) Payment of Charges

When the Telephone Company purchases Call Recording from another telephone company and/or Message Processing Services from another telephone company or entity for a customer, the rates and charges for such services contained in this tariff are applicable.

(6) Customer's End User Deposits

When Bill Rendering, Online Bill Pay and Fundamental Billing Services are ordered, the Telephone Company will determine and collect a deposit from the customer's end user in accordance with the Telephone Company deposit regulations. The Telephone Company will provide the customer with a copy of its deposit regulations upon request.

8.1.3 Description of Billing and Collection Services

Billing and Collection Services consist of those functions provided in conjunction with Facilities for Intrastate Access (FIA) which the Telephone Company offers in other sections of this tariff. Billing and Collection Services are as follows:

Applies to All Exchanges Illinois

FACILITIES FOR INTRASTATE ACCESS

8. ANCILLARY SERVICES (Cont'd)

8.1 Billing and Collection Service (Cont'd)

8.1.3 Description of Billing and Collection Services (Cont'd)

(A) Call Recording Service

The Telephone Company will provide Call Recording in Telephone Company suitably equipped end offices or tandems. Call Recording is available with FGC, FGD or similar Feature Group offerings when used in the provision of MTS/WATS services. Call Recording is the entering on magnetic tape or other acceptable media the details of customer messages originated through Switched Access Service or Switched Access-like service for which answer and disconnect supervision has been received. The Telephone Company will provide the customer, upon request, the recorded message detail, as agreed to by both parties, for each completed intrastate message generated by end users gaining access to the customer from the Access Area.

The equipment at the customer designated location shall provide such signals as may be required for the proper operation of the Telephone Company's automatic call recording equipment used to perform this function.

The Telephone Company may purchase Call Recording Service from another telephone company. Another telephone company or entity may purchase Call Recording Service from the Telephone Company.

A standard format for the provision of the recorded message detail will be established by the Telephone Company. The Telephone Company will provide to the customer the precise details of the format. If, in the course of Telephone Company business, it is necessary to change the format, the Telephone Company will provide notification to the customer six months in advance of the change.

(B) Message Processing Service

Message Processing Service consists of the transformation of recorded customer message details into rated messages. Message Processing Service will be provided for each intrastate message generated by end users gaining access to the customer from the Access Area of the Telephone Company. Message Processing Service includes the following:

Applies to All Exchanges Illinois

FACILITIES FOR INTRASTATE ACCESS

8. ANCILLARY SERVICES (Cont'd)

8.1 Billing and Collection Service (Cont'd)

8.1.3 Description of Billing and Collection Services (Cont'd)

(B) Message Processing Service (Cont'd)

(1) Assembly of Message Detail

This function consists of arranging the customer's recorded message details into a format required for subsequent processing.

(2) Editing of Message Detail

This function consists of examining individual message details and identifying the messages with errors or the messages which require further examination.

(3) Rating of Messages

This function consists of calculating the charges for messages based on the customer's schedule of charges and the message detail.

The Telephone Company will provide Message Processing Service only for customer messages originated within the Access Area.

For the purpose of performing Message Processing Service, the Telephone Company may purchase Message Processing Service from another telephone company or entity as set forth in 8.1.2(C)(5). Another telephone company or entity may purchase Message Processing Service from the Telephone Company.

Where the customer provides its own message details, it must be in the standard format established by the Telephone Company. The Telephone Company will provide to the customer the precise details of the required format. If, in the course of Telephone Company business, it is necessary to change the format, the Telephone Company will provide notification to the customer six months in advance of the change.

Where the Telephone Company has rated customer messages which are to be billed to an end user by another telephone company or entity, the Telephone Company will enter the customer messages on a magnetic tape or data file and transmit the rated messages as set forth in 8.1.3(E).

Applies to All Exchanges Illinois

FACILITIES FOR INTRASTATE ACCESS

8. ANCILLARY SERVICES (Cont'd)

8.1 Billing and Collection Service (Cont'd)

8.1.3 Description of Billing and Collection Services (Cont'd)

(C) Assembly and Editing Service

Assembly is the aggregation of recorded message details to create individual messages for rating. Editing is the process of verifying that the assembled message data is in accordance with the Telephone Company standard format and prescribed Exchange Message Interface (EMI) specifications.

The editing function consists of examining individual message details and identifying the messages with errors or the messages requiring further examination. The editing process includes the validation of data categories such as, but not limited to, the following:

- Called Telephone Number
- Calling Telephone Number
- Date

The assembled and edited recorded message detail will be provided to the customer as set forth in 8.1.3(D).

(D) Call Record Provision Service

Call Record Provision Service is the transmission and receipt of rated and unrated message data. It also includes the transmission of end user data as a result of customer generated activity (i.e., transmitting end user data during conversion activities, etc.)

The billing information and/or end user data may be transmitted or received on magnetic tape or other acceptable media via either of two principal methods:

- Hand carried recording media (i.e., magnetic tape).
- Direct interface (data link) to the Telephone Company billing center

The Telephone Company will determine the number of magnetic tapes required to transmit message/record data to the customer, another telephone company or billing entity.

Applies to All Exchanges Illinois

FACILITIES FOR INTRASTATE ACCESS

8. ANCILLARY SERVICES (Cont'd)

8.1 Billing and Collection Service (Cont'd)

8.1.3 Description of Billing and Collection Services (Cont'd)

(E) Message Bill Processing Service

Message Bill Processing Service is the accumulation, guiding and preparation of messages (including the application of taxes) for end user bill rendering MTS/WATS¹ services. (C)

Message-Billed Message Bill Processing Service is the accumulation, guiding, posting and formatting of rated message detail for bill rendering. The Telephone Company will process Calling Plans (i.e., Directory Assistance, Optional Calling Plans, Dial-It calls, etc.) that require the application of a discount to aggregate MTS usage as a part of its Message-Billed Message Bill Processing Service.

Bulk-Billed Message Bill Processing Service is the accumulation, guiding and posting of rated message detail where the individual message detail is not provided on the bill rendered to the end user.

The rating may have been done by the Telephone Company, another entity or the customer. Where a customer subscribes to Message Processing Service, as set forth in 8.1.3(B), the rated customer messages will be used as the input. If the customer provides the rated messages, the end user account to be billed shall be identified and the records shall be provided in the standard format established by the Telephone Company and delivered, as set forth in 8.1.3(D) or 8.1.4(M), to the location specified by the Telephone Company.

If the customer provided rated messages must be converted by the Telephone Company to the standard format, and the Telephone Company agrees to make the conversion, program development charges as set forth in 8.1.5 apply for the hours required to design, develop, test and maintain the necessary programs. If, in the course of Telephone Company business, it is necessary to change the format, the Telephone Company will provide notification to the customer six months in advance of the change.

¹ Wide Area Telecommunications Service (WATS) offering is grandfathered as of August 31, 2020 and limited to existing subscribers at their existing locations. (N)
(N)

Issued: July 13, 2020

Effective: August 31, 2020

By Kenneth Mason
Vice President
of Government and Regulatory Affairs

Applies to All Exchanges Illinois

FACILITIES FOR INTRASTATE ACCESS

8. ANCILLARY SERVICES (Cont'd)

8.1 Billing and Collection Service (Cont'd)

8.1.3 Description of Billing and Collection Services (Cont'd)

(E) Message Bill Processing Service (Cont'd)

The Telephone Company will only provide Message Bill Processing Service when Bill Rendering Service and Record Keeping are ordered.

The Message Bill Processing Service rate band will be determined by the Telephone Company for each customer based on the total number of interstate and intrastate messages per year.

(F) Bill Rendering Service

Bill Rendering Service is the printing and mailing of statements showing amounts due from end users for services provided by the customer. Bill Rendering Service includes payment and remittance processing, treatment, denial of service and collection of deposits (where appropriate) and other monies due from the end user. Bill Rendering Service is provided on a per bill basis.

When the Telephone Company provides Bill Rendering Service, the customer's statement of the amount due may, at Telephone Company option, be included as part of the regular monthly bill for local exchange service mailed to the end user.

Applies to All Exchanges Illinois

FACILITIES FOR INTRASTATE ACCESS

8. ANCILLARY SERVICES (Cont'd)

8.1 Billing and Collection Service (Cont'd)

8.1.3 Description of Billing and Collection Services (Cont'd)

(F) Bill Rendering Service (Cont'd)

The Telephone Company may, in accordance with its deposit regulations, determine and collect a deposit from the end user for the customer's services as set forth in 8.1.2(C)(6). When necessary, the Telephone Company, in accordance with its treatment procedures, shall deny the customer's services and/or local exchange services to an end user. Where local exchange service access is denied, access to the customer services will also be denied.

Bill Rendering Service will only be provided in conjunction with the purchase of a customer's receivables. The Telephone Company will not be responsible for any customer's balance due from end users prior to the initial order period.

The Telephone Company will only provide Bill Rendering Service when Message Bill Processing Service with Record Keeping are ordered or when Fundamental Billing Service is ordered.

The Bill Rendering Service rate band will be determined by the Telephone Company for each customer based on the total number of bills per year.

(G) Message Investigation Service

The Telephone Company will provide Message Investigation Service when requested by the customer. Message Investigation Service is that activity undertaken by the Telephone Company to secure, or attempt to secure proper billing information in an effort to sustain or recharge the customer's message. The Telephone Company will investigate, at the request of the customer, unbillable messages to correct message detail information to allow for the proper billing application.

Applies to All Exchanges Illinois

FACILITIES FOR INTRASTATE ACCESS

8. ANCILLARY SERVICES (Cont'd)

8.1 Billing and Collection Service (Cont'd)

8.1.3 Description of Billing and Collection Services (Cont'd)

(G) Message Investigation Service (Cont'd)

The customer's request for Message Investigation Service shall identify the customer message, the date the customer message was billed and the amount of the customer message. Message Investigation Service is provided on a per message investigated basis.

Message Investigation Service will be provided for each intrastate message generated by end users gaining access to the customer MTS/WATS¹ services from the Access Area of the Telephone Company. (C)

(H) Online Bill Pay Service

Online Bill Pay Service includes the preparation of bills, mailing of the bills to the end users and the collection of deposits and monies due from the end users. Online Bill Pay Service also includes master file maintenance.

Online Bill Pay Service is provided on a per message billed basis (message-billed). The Telephone Company will process Calling Plans (i.e., Directory Assistance, Optional Calling Plans, Dial-It calls, etc.) that require the application of a discount to aggregate MTS usage as a part of its message-billed billing.

When Online Bill Pay Service is ordered, the Telephone Company will accumulate, guide and post rated messages in preparation for billing (includes the application of taxes). The Telephone Company will also print and mail statements showing amounts due from end users for MTS services provided by the customer.

Collection Service provided to the customer will include receiving payments from the customer's end users, treatment of receivables, treatment of accounts, master file maintenance and collection of deposits (where appropriate) as set forth in 8.1.2(C)(6). When necessary, the Telephone Company, in accordance with its treatment procedures, shall deny the customer's services and/or local exchange services to an end user. Where local exchange service access is denied, access to the customer services will also be denied.

¹ Wide Area Telecommunications Service (WATS) offering is grandfathered as of August 31, 2020 and limited to existing subscribers at their existing locations. (N)

Applies to All Exchanges Illinois

FACILITIES FOR INTRASTATE ACCESS

8. ANCILLARY SERVICES (Cont'd)

8.1 Billing and Collection Service (Cont'd)

8.1.3 Description of Billing and Collection Services (Cont'd)

(H) Online Bill Pay Service (Cont'd)

The rating may have been done by the Telephone Company, another entity or the customer. Where the customer subscribes to Message Processing Service as set forth in 8.1.3(B), the rated customer messages will be used as the input. If the customer or another entity provides the rated messages, the end user account to be billed shall be identified and the records shall be provided in the standard format established by the Telephone Company and delivered as set forth in 8.1.3(D) or 8.1.4(M).

Online Bill Pay Service will only be provided in conjunction with the purchase of a customer's receivables. The Telephone Company will not be responsible for any customer's balance due from end users prior to the initial order period.

Applies to All Exchanges Illinois

FACILITIES FOR INTRASTATE ACCESS

8. ANCILLARY SERVICES (Cont'd)

8.1 Billing and Collection Service (Cont'd)

8.1.3 Description of Billing and Collection Services (Cont'd)

(I) Fundamental Billing Service

Fundamental Billing Service is the centralized receipt of Fundamental Billing Service records for inclusion on the end user bill.

Fundamental Billing Service includes the preparation of bills, mailing of statements of the amount due for services provided by the customer and the collection of deposits (where appropriate) and monies due from the customer's end users. Fundamental Billing Service also includes account establishment, maintenance of accounts and treatment of accounts.

When the Telephone Company provides Fundamental Billing Service, the customer shall rate its end users messages, calculate the taxes and the total amount (surcharges, discounts, allowances, recurring fees, etc.) to be billed for services it provided to its end users, prior to sending the Fundamental Billing Service records to the Telephone Company.

The customer's statement of the amount due may, at Telephone Company option, be included as part of the regular monthly bill for local exchange service mailed to the end user.

As a part of its treatment procedures, the Telephone Company shall have the final authority to make adjustments or deny service for disputed charges on the end user's account.

Fundamental Billing Service will only be provided in conjunction with the purchase of a customer's receivables. The Telephone Company will not be responsible for any customer's balance due from end users prior to the initial order period.

Call Record Provision charges, as set forth in 8.1.5, shall apply for the receipt of accepted messages and the return of rejected messages. Bill Rendering charges, as set forth in 8.1.5, shall apply for each bill rendered. In addition, the Fundamental Billing Service Charges as set forth in 8.1.5 shall apply.

Applies to All Exchanges Illinois

FACILITIES FOR INTRASTATE ACCESS

8. ANCILLARY SERVICES (Cont'd)

8.1 Billing and Collection Service (Cont'd)

8.1.3 Description of Billing and Collection Services (Cont'd)

(J) Program Development Service

Program Development Service consists of developing the customer's schedule of rates into a rating program and changing the bill format when requested by the customer. Program Development Service also includes converting message data, transmitted to the Telephone Company by the customer or another entity, into the Telephone Company standard format for processing.

A Program Development Charge, as set forth in 8.1.5, applies for the programming hours required for software designing and coding.

A Program Implementation Charge applies for table updating, testing, administration, documenting program changes and other implementation activities.

Changes in the rate levels of customer charges to be billed will normally be implemented within 30 days after receipt of an order from the customer requesting such change. When modification to the rating program is required, a Program Development Charge will also apply. Changes in rate structure will normally be completed within six months of a customer's order.

The complexity of the structural change will determine the exact length of time necessary to fulfill the request. Rate structure changes will be made only when the Telephone Company can accommodate such changes.

(K) Inquiry Service

Inquiry Service consists of answering end user questions about charges billed for the customer's services, applying credits and adjustments to end user accounts, and reviewing messages removed from end user bills.

Applies to All Exchanges Illinois

FACILITIES FOR INTRASTATE ACCESS

8. ANCILLARY SERVICES (Cont'd)

8.1 Billing and Collection Service (Cont'd)

8.1.3 Description of Billing and Collection Services (Cont'd)

(K) Inquiry Service (Cont'd)

When the Telephone Company provides Inquiry Service, the Telephone Company will be responsible for contacts and arrangements (either written or oral) with the customer's end users concerning the billing, collecting, crediting, adjusting and message investigation of the customer's service charges in accordance with written instructions furnished by the customer and agreed to by the Telephone Company. Billed messages removed from an end user's bill will be appropriately adjusted to the customer's account receivable as agreed to by both parties.

The Telephone Company will not become involved in disputes between a customer and its end users. Consequently, utilizing Telephone Company guidelines previously established for the collection process for its own accounts, the Telephone Company may remove a disputed customer's charge from an end user's bill and deduct that amount from the customer's accounts receivable. It will be the customer's responsibility to pursue the collection of the disputed amount.

The Telephone Company shall have the final authority to make adjustments or deny service for disputed charges on end users' accounts.

Inquiry Service will only be provided in conjunction with the purchase of a customer's receivables. The Telephone Company will not be responsible for any customer's balances due from end users prior to the initial order period.

Inquiry Service will only be provided when Message Bill Processing, Online Bill Pay Service is ordered. Inquiry Service will only be provided in the Telephone Company operating territory.

Inquiry Service consists of a bifurcated rate structure, a per message billed rate and a per adjustment rate.

Applies to All Exchanges Illinois

FACILITIES FOR INTRASTATE ACCESS

8. ANCILLARY SERVICES (Cont'd)8.1 Billing and Collection Service (Cont'd)8.1.4 Rate Regulations

- (A) Call Recording Service for MTS/WATS¹ services includes the functions listed in 8.1.3(A). The rate, as set forth in 8.1.5, applies per message recorded. (C)
- (B) Message Processing Service for MTS/WATS¹ services includes the functions listed in 8.1.3(B). The rate, as specified in 8.1.5, applies per message processed. In those locations where WATS¹ services are metered, or the billing record is summarized by another telephone company, the Message Processing rate, as set forth in 8.1.5, will apply per billing record processed. For rating purposes, a billing record is defined as any record which is required to be processed to accomplish billing of a customer's WATS¹ usage. (C)
- (C) Assembly and Editing Service for MTS/WATS¹ services consists of the functions listed in 8.1.3(C). The rate, as specified in 8.1.5 applies per message assembled and edited. (C)
- (D) When message detail is transmitted to or received from the customer, another telephone company or billing entity, a Call Record Provision charge will apply. For the purpose, a record is a logical grouping of information as described in the program that processes the information and loads the magnetic tape or data file. The rate, as specified in 8.1.5, applies per record transmitted or received. The Telephone Company will determine the Call Record Provision charge based on its count of the records transmitted or received. (C)
- (E) The Message Bill Processing Service charge applies whenever the Telephone Company performs the functions listed in 8.1.3(E). The rate for Message Bill Processing Service shall be the rate corresponding to the Message Bill Processing Service rate for such volume of messages as set forth in 8.1.5 on a calendar year basis. As used in this tariff, the term calendar year shall mean the period from January 1 through December 31 (both dates inclusive) of a given year. The Message Bill Processing Service rate band will be determined by the Telephone Company for each customer based on the total number of interstate and intrastate messages per year. (C)

¹ Wide Area Telecommunications Service (WATS) offering is grandfathered as of August 31, 2020 and limited to existing subscribers at their existing locations. (N)
(N)

Applies to All Exchanges Illinois

FACILITIES FOR INTRASTATE ACCESS**8. ANCILLARY SERVICES (Cont'd)****8.1 Billing and Collection Service (Cont'd)****8.1.4 Rate Regulations (Cont'd)****(E) (Cont'd)**

The Telephone Company will use the customer provided message capacity to determine the band and its associated rate, during the first year of the initial minimum period. During the first quarter of the next year, the customer and the Telephone Company will determine the actual volume of messages for which the Telephone Company performed Message Bill Processing Service. Such actual volumes shall be compared to the Message Bill Processing Service bands as set forth in 8.1.5 to determine which band such actual volume of messages fall. If the actual volume is greater than or less than customer provided message capacity, the actual volume will be multiplied by the appropriate band rate and compared to the billed volume to determine either a charge or credit. This charge or credit will be applied to the customer's subsequent bill.

For each year thereafter, the Telephone Company and the customer shall utilize the previous years actual volume of messages and the customer provided message capacity in an effort to determine the appropriate band for the next calendar year. In the first quarter of each year, the procedure described in the previous paragraph will be followed.

The rate, as specified in 8.1.5, applies per message processed. The bulk-billed message Bill Processing Service charge applies per WATS ¹/800 message processed. (C)

¹ Wide Area Telecommunications Service (WATS) offering is grandfathered as of August 31, 2020 and limited to existing subscribers at their existing locations. (N)

Applies to All Exchanges Illinois

FACILITIES FOR INTRASTATE ACCESS

8. ANCILLARY SERVICES (Cont'd)

8.1 Billing and Collection Service (Cont'd)

8.1.4 Rate Regulations (Cont'd)

- (F) Bill Rendering Service includes the functions listed in 8.1.3(F). The rate for Bill Rendering shall be the rate corresponding to the Bill Rendering Service rate for such volume of bills for a particular billing service as set forth in 8.1.5 on a calendar year basis. As used in this tariff, the term calendar year shall mean the period from January 1 through December 31 (both dates inclusive) of a given year. The Bill Rendering Service rate band is determined by the Telephone Company for each customer based on the total number of bills per year.

The Telephone Company will use the customer provided bill capacity to determine the band and its associated rate the first year of the initial minimum period. During the first quarter of the next year, the customer and the Telephone Company will determine the actual volume of bills for which the Telephone Company performed Bill Rendering Service. Such actual volumes shall be compared to the Bill Rendering Service Bands as set forth in 8.1.5 to determine which band such actual volume of bills fall. If the actual volume is greater than or less than the customer provided bill capacity, the actual volume will be multiplied by the appropriate band rate and compared to the billed volume to determine either a charge or credit. This charge or credit will be applied to the customer's subsequent bill.

For each year thereafter, the Telephone Company and the customer shall utilize the previous year's actual volume of bills and the customer provided bill capacity in an effort to determine the appropriate band for the next calendar year. In the first quarter of each year, the procedures described in the previous paragraph will be followed.

The rate, as specified in 8.1.5, applies per bill rendered. A factor, based on actual interstate and intrastate billed messages, will be used by the Telephone Company to apportion the Bill Rendering charge by jurisdiction.

Applies to All Exchanges Illinois

FACILITIES FOR INTRASTATE ACCESS

8. ANCILLARY SERVICES (Cont'd)

8.1 Billing and Collection Service (Cont'd)

8.1.4 Rate Regulations (Cont'd)

- (G) Message Investigation Service consists of the functions listed in 8.1.3(G). The rate, as specified in 8.1.5, applies per message investigated by the Telephone Company.
- (H) Online Bill Pay Service consists of the functions listed in 8.1.3(H). The rate, as specified in 8.1.5, applies per message.
- (I) Fundamental Billing Service consists of the functions listed in 8.1.3(I). The rates, as set forth in 8.1.5, apply per message, per bill.
- (J) A Record Keeping charge applies for each end user account maintained by the Telephone Company for the customer. An end user account is a record which has a name and address and a unique billing identification number assigned by the Telephone Company to which a bill is rendered. The Record Keeping charge, as specified in 8.1.5, applies per month for each account and/or line maintained. A factor, based on actual interstate and intrastate billed messages, will be used to apportion the Record Keeping charge by jurisdiction.
- (K) An Exchange Carrier Memorandum (EC Memo) charge will be assessed each time the customer requests a manual adjustment to an end user account. The EC Memo charge, as specified in 8.1.5, applies per account adjusted per memo. When necessary, a factor (based on actual interstate and intrastate adjusted messages) will be used to apportion the EC Memo charge by jurisdiction.
- (L) A Service Order Change Charge applies whenever a billing service order is accepted by the Telephone Company to update (i.e., add, change or delete) its billing file to implement the requested activity. The Service Order Change Charge, as set forth in 8.1.5, applies per order processed.

Applies to All Exchanges Illinois

FACILITIES FOR INTRASTATE ACCESS

8. ANCILLARY SERVICES (Cont'd)

8.1 Billing and Collection Service (Cont'd)

8.1.4 Rate Regulations (Cont'd)

(M) A Centralized Message Dispersion charge will apply when the Telephone Company provides a single point for the receipt of customer message data. The Telephone Company will receive, edit, sort, disperse and confirm the number of accepted billable messages and the total amount due the customer for services provided to its end users. In addition, the rated and/or unrated message data is dispersed to the appropriate location for further processing and/or billing. The rates, as set forth in 8.1.5, will apply per message processed. Call Record Provision charges, as set forth in 8.1.5, will apply for the receipt of each billable message and the transmission of each unbillable message. This charge does not apply to Fundamental Billing Service.

(N) Inquiry Service includes the functions listed in 8.1.3(K). Inquiry Service consists of a bifurcated rate structure, a per message billed and a per adjustment rate. The Inquiry Service per message billed rate applies for each customer message billed by the Telephone Company. The per message adjustment rate applies for each occurrence of an adjustment made to an end user bill (account).

A PIU factor will be used by the Telephone Company to apportion the message adjustment rate by jurisdiction.

Applies to All Exchanges Illinois

FACILITIES FOR INTRASTATE ACCESS

8. ANCILLARY SERVICES (Cont'd)

8.1 Billing and Collection Service (Cont'd)

8.1.5 Rates and Charges

	<u>Rate</u>	
(A) Program Development, Per Hour	\$94.00	
(B) Program Implementation, Per Hour	55.00	
(C) Service Order Change Charge, Per Order.....	4.00	
(D) MTS/WATS ¹ /800 Services		(C)
(1) Call Recording Service, Per Message.....	.0150	
(2) Message Processing Service, Per Message.....	.0100	
(3) Assembly and Editing Service, Per Message0075	
(4) Bill Rendering Service, Per Bill		
0 to 789,3003500	
789,301 to 1,140,100.....	.3000	
1,140,101 to 4,908,999.....	.2700	
4,909,000 to 5,260,000.....	.2500	
Over 5,260,0002300	
(5) Online Bill Pay Service,		
Per Message.....	.0762	
(6) Message Investigation, Per Message	2.50	
(E) Call Record Provision Service		
(1) Via Magnetic Tape, Per Message Record		
Transmitted or Received0100	
(2) Via Direct Interface, Per Message Record		
Transmitted or Received0020	

¹ Wide Area Telecommunications Service (WATS) offering is grandfathered as of August 31, 2020 and limited to existing subscribers at their existing locations. (N)
 (N)

Applies to All Exchanges Illinois

FACILITIES FOR INTRASTATE ACCESS

8. ANCILLARY SERVICES (Cont'd)

8.1 Billing and Collection Service (Cont'd)

8.1.5 Rates and Charges (Cont'd)

	<u>Rate</u>
(F) Message-Billed	
(1) Message Bill Processing Service, Per Message	
0 to 33,451,299	\$.0762
33,451,300 to 44,601,799.....	.0400
44,601,800 to 66,902,699.....	.0200
66,902,700 to 78,053,099.....	.0170
78,053,100 to 100,353,999.....	.0170
100,354,000 to 122,655,000.....	.0160
Over 122,655,0000150
(2) Bulk-Billed, Per Message.....	.0200
(G) Fundamental Billing Service, Per Message	
(1) Messages Per End User Account, Per Month	
1 to 10 Messages0310
Over 10 Messages0190
(H) EC Memo, Per Account.....	10.00
(I) Record Keeping, Per Account.....	.0300
(J) Centralized Message Dispersion, Per Message0020
(K) Inquiry Service	
(1) Per Message Billed.....	.0078
(2) Per Adjustment	2.00

Applies to All Exchanges Illinois

FACILITIES FOR INTRASTATE ACCESS

8. ANCILLARY SERVICES (Cont'd)

8.2 Directory Assistance Service

8.2.1 General

The Telephone Company will provide Directory Assistance Service to a customer from Directory Assistance Service locations.

Regulations, rates and charges as follow apply to Directory Assistance Service and shall not serve as a substitute for customer tariff offerings of services to end users. The provision of such Directory Assistance Service by the Telephone Company as set forth following does not constitute a joint undertaking with the customer for the furnishing of any service.

The Telephone Company's undertaking to provide Directory Assistance Service from this tariff is made in conjunction with intrastate services.

The regulations, rates and charges contained herein are in addition to the applicable regulations, rates and charges specified in other sections of this tariff and in other tariffs of the Telephone Company which are referenced herein. For Switched Access connections to the Directory Assistance Service location, the rates as set forth in Section 4 apply. For Special Access connections to the Directory Assistance Service location, the rates as set forth in Section 5 apply.

Switched Access connections to Directory Assistance service locations shall require the use of Switched Access Entrance Facilities and Direct-Trunked Transport. Switched Access Entrance Facilities provide the facilities and necessary interface between the customer's CDL and the serving wire center. Switched Access Direct-Trunked Transport provides the interoffice facilities between the serving wire center and the Directory Assistance service location. In addition to Directory Assistance rates described in this section, Entrance Facility and Direct-Trunked Transport rates are applied as described in Section 4.5.2(G)(2)(d) and 4.5.2(G)(2)(e).

8.2.2 Description of Service

Directory Assistance Service provides access to Directory Assistance Service locations, use of Directory Assistance Service equipment, and use of Directory Assistance operators. This function consists of Directory Assistance Service to a customer to enable end users to obtain local telephone numbers maintained by the Telephone Company.

Applies to All Exchanges Illinois

FACILITIES FOR INTRASTATE ACCESS

8. ANCILLARY SERVICES (Cont'd)

8.2 Directory Assistance Service (Cont'd)

8.2.3 Undertaking of the Telephone Company

(A) Discontinuance and Refusal of Directory Assistance Service

- (1) If the customer fails to comply with the provisions of this tariff, including any payments to be made by it on the dates or at the times herein specified, and fails within thirty (30) days after written notice via certified mail from the Telephone Company to an officer of the customer requesting payment for such noncompliance, the Telephone Company may discontinue the provision of the Directory Assistance Service. In case of such discontinuance, all applicable charges shall immediately become due.
- (2) If the customer repeatedly fails to comply with the provisions of this tariff in connection with the provision of Directory Assistance Service and fails to correct such course of action after notice as set forth in (1) preceding, the Telephone Company may refuse applications for additional Directory Assistance Service.

8.2.4 Obligations of the Customer

(A) Request for Service

Directory Assistance Service will be offered for a minimum period of six months. Three months prior to the end of the minimum period, or subsequent extension, the customer shall notify the Telephone Company, in writing, if the service is to be discontinued. If no notice is received from the customer, the Telephone Company shall assume that the service is extended for another six months.

(B) ASR Requirements

When Directory Assistance Service is ordered, the customer shall furnish the Telephone Company, for each NPA, and for each month in the order period, an estimate of the number of calls (call capacity) to be billed. At a minimum, the customer is required to revise this estimate semi-annually. More frequent revisions of the estimates may be submitted; however, no more than once per month.

Applies to All Exchanges Illinois

FACILITIES FOR INTRASTATE ACCESS

8. ANCILLARY SERVICES (Cont'd)

8.2 Directory Assistance Service (Cont'd)

8.2.5 Payment Arrangements

(A) Minimum Charges

After service has been provided for a period of 3 months the customer is subject to minimum monthly charges if in any month within the period ordered the actual call volumes are:

- less than 75% of any one of the previous months' actual calls in the period ordered, or
- less than 75% of the highest forecast in the period ordered, whichever is higher.

Applicability of minimum charges shall be made by comparing the actual call volumes to either the forecasted volumes or the previous months' actual call volumes, whichever is higher.

The minimum monthly charge is computed using the difference between the actual call volume for a month and the calculated minimum (i.e., 75% of the highest forecast or 75% of any previous months' actual), multiplied by the appropriate Directory Assistance Service charge, and then multiplied by 0.5.

(B) Minimum Period Disconnect Charges

If service is discontinued prior to the end of six months when Directory Assistance Service is ordered, then the customer shall be obligated to pay the Telephone Company nonrecoverable costs, less the net salvage value for any equipment and material provided or used, for the discontinued service. Such charges will be tariffed as they occur.

Applies to All Exchanges Illinois

FACILITIES FOR INTRASTATE ACCESS

8. ANCILLARY SERVICES (Cont'd)

8.2 Directory Assistance Service (Cont'd)

8.2.6 Rate Regulations

- (A) The Telephone Company Directory Assistance operator, when furnished a name, will provide or attempt to provide the telephone number listed in the Telephone Company Directory Assistance records associated with the name given. The Telephone Company's contact with the end user shall be limited to such contact necessary to process an end user's request for a telephone number.
- (B) A maximum of two requests for telephone numbers will be processed per access to the Directory Assistance operator.
- (C) A telephone number which is not listed in Directory Assistance records will not be available to the end user.
- (D) The Telephone Company reserves the right to determine from which Directory Assistance Service location the service will be provided.
- (E) In the event that a telephone number is not listed in the Directory Assistance records and no number is provided, no credit applies for the call to the Directory Assistance operator.

The customer will receive credit allowances on Directory Assistance Service charges for FIA interruptions.

- (F) The Directory Assistance per call charge, as set forth in 8.2.7, applies for each call to a Directory Assistance service location. A chargeable call is one which has been answered by or forwarded to a Directory Assistance operator. The charge applies whether or not the Directory Assistance operator provides the requested telephone number. The number of calls answered or forwarded to Directory Assistance operators will be accumulated by the Telephone Company measuring equipment.

8.2.7 Rates and Charges

Directory Assistance Service	
Per Call Rate.....	\$0.2550

Applies to All Exchanges Illinois

FACILITIES FOR INTRASTATE ACCESS

8. ANCILLARY SERVICES (Cont'd)

8.3 Operator Services

Operator Services described in this Section will be provided to access customers as an optional feature in conjunction with Feature Group C (FGC) or Feature Group D (FGD), BSA-C or BSA-D Switched Access Services from designated Operator Services Switching locations in those MSAs where the Telephone Company has the capability to provide such services. Operator Services include Operator Transfer and Inward Operator Assistance functions which enable a customer to provide operator related services to their end users. A customer may order both Operator Transfer and Inward Operator Assistance Services or may order them individually.

8.3.1 General Description

(A) Operator Transfer Service

Operator Transfer Service is an originating service that provides call transfer of 0- (the digit 0 with no additional digits) interMSA calls to a participating customer as requested by the calling end user. Operator Transfer Service is provided when an end user dials "0" and is routed to the Telephone Company's operator and requests completion of an interMSA call. Operator Transfer Service provides for the routing of the call from the Telephone Company's Operator Services Switching Location to one customer designated location in the same MSA.

The Telephone Company operator will ask the end user to identify the customer to which they desire to be connected. The operator will then transfer the call to the designated customer.

If the end user has no preference, or the identified customer has not subscribed to Operator Transfer Service, the end user will be asked to select from a list of participating customers. The list of participating Operator Transfer Service customers will be updated monthly. The order in which participating customers will appear on the list will be initially determined by use of a random drawing. For each subsequent monthly update following the initial selection, the customer in the first position will be moved to the last position on the list. All other customers will be moved up one position. New Operator Transfer Service customers will be placed at the bottom of the list of participating customers pending the next monthly update.

Applies to All Exchanges Illinois

FACILITIES FOR INTRASTATE ACCESS

8. ANCILLARY SERVICES (Cont'd)

8.3 Operator Services (Cont'd)

8.3.1 General Description (Cont'd)

(B) Inward Operator Assistance Service (Cont'd)

Inward Operator Assistance Service provides for operator assistance on inward calls received from a customer's operator. Inward Operator Assistance functions is provided as described below. Each call may include any combination of functions for the same telephone number. Only one telephone number per call will be handled by the operator.

(T)

(1) Reserved for Future Use.

(D)

(2) Reserved for Future Use.

(D)

(3) Operator Assistance - The Telephone Company operator will provide the customer's operator with assistance or information regarding service conditions.

Applies to All Exchanges Illinois

FACILITIES FOR INTRASTATE ACCESS

8. ANCILLARY SERVICES (Cont'd)

8.3 Operator Services (Cont'd)

8.3.2 Service Provisioning

- (A) The Telephone Company will provide Operator Transfer Service for calls originating from all end offices within the MSA served by a designated Operator Services Switching Location.

The Telephone Company will provide Inward Operator Assistance Service for calls associated with exchange service lines in end offices served by the Operator Services Switching Location.

A list of end offices served by the Operator Services Switching Location will be provided to the customer upon request.

- (B) Operator Services will be provided over FGC, FGD, BSA-C or BSA-D trunk groups, arranged for either one-way or two-way calling, from the Operator Services Switching Location to one customer designated location in the same MSA. Both Operator Transfer and Inward Operator Assistance traffic may be combined on the same trunk group.
- (C) Switched Access used in conjunction with Operator Services will be provisioned in accordance with the technical specifications and requirements set forth in Section 4 of this tariff.
- (D) Designated Telephone Company Operator Services Switching Locations are identified in the National Exchange Carrier Association Tariff FCC No. 4. The designated locations will be in those MSAs in which the Telephone Company is able to provide Operator Services.

Applies to All Exchanges Illinois

FACILITIES FOR INTRASTATE ACCESS

8. ANCILLARY SERVICES (Cont'd)

8.3 Operator Services (Cont'd)

8.3.3 Rate Regulations

Where the Telephone Company has measurement capability for Operator Services per call charges, the Telephone Company will bill the actual usage measured on a per call basis. For Operator Transfer Service, FGC, FGD, BSA-C or BSA-D access minutes will also be billed in addition to the per call charge.

When measurement capability is not available, the customer shall furnish a forecast of the number of calls (call capacity) anticipated for each month of the succeeding year by type of call (i.e., Operator Transfer and Inward Operator Assistance calls) and by Operator Services Switching Location at the time the order is placed. For mixed intrastate and interstate services, the customer's estimate shall include the percent of intrastate calls. At a minimum, the customer shall revise this forecast annually. More frequent revisions of the forecast may be submitted, however, no more than once per month.

Such estimates shall be used as a basis for billing the Operator Services per call charges until such time as the Telephone Company has actual measurement capability available. The customer shall maintain records supporting such estimates.

(A) Operator Transfer Service

Operator Transfer Service Rate

The Operator Transfer Service Rate is assessed per 0- call transferred to a customer. A 0- call is considered transferred when the Telephone Company operator activates the transfer function sending the call to the designated customer.

Switched Access Charges

FGC or FGD Switched Access usage charges and Carrier Common Line Charges will also apply per minute of use for Operator Transfer Service.

Applies to All Exchanges Illinois

FACILITIES FOR INTRASTATE ACCESS

SECTION 9 TABLE OF CONTENTS

9. <u>SPECIAL FACILITIES ROUTING OF FIA</u>	<u>Page</u>
9.1 <u>Description of Special Facilities Routing of FIA</u>	2
9.1.1 Diversity	2
9.1.2 Avoidance.....	2
9.1.3 Cable-Only Facilities	2
9.2 <u>Rates and Charges</u>	3
9.2.1 Diversity	3
9.2.2 Avoidance.....	3
9.2.3 Diversity and Avoidance Combined	3
9.2.4 Cable-Only Facilities	3

Applies to All Exchanges Illinois

FACILITIES FOR INTRASTATE ACCESS

9. Special Facilities Routing of FIA

9.1 Description of Special Facilities Routing of FIA

The FIA provided under this tariff are provided over such routes and facilities as the Telephone Company may elect. Special routing is involved where, in order to comply with requirements specified by the customer, the Telephone Company provides Switched Access, Special Access, or Special Federal Government Services in a manner which includes one or more of the following conditions.

9.1.1 Diversity

Where two or more FIA must be provided over not less than two different physical routes. Diversity is a Basic Service Element (BSE) under the Telephone Company's Open Network Architecture (ONA) plan.

9.1.2 Avoidance

Where a FIA must be provided on a route which avoids specified geographical locations.

9.1.3 Cable-Only Facilities

Where certain voice grade FIA are provided on cable-only facilities to meet the particular needs of a customer. FIA is provided subject to the availability of cable-only facilities. In the event of FIA failure, restoration will be made through the use of any available facilities as selected by the Telephone Company.

Avoidance and Diversity are available on Switched Access as set forth in Section 4, Special Access as set forth in Section 5, and Special Federal Government Services as set forth in Section 11. Cable-only facilities are available for Switched Access as set forth in Section 4, voiceband Special Access as set forth in 5.2.1 and Special Federal Government Services as set forth in Section 11.

In order to identify any special routing requirement, the Telephone Company will provide the ordering customer with the required routing information for each specially routed FIA. If requested by the customer, this information will be provided when the FIA is installed and prior to any subsequent change in routing.

The rates and charges for Special Facilities Routing of FIA as set forth in 9.2 following are in addition to all other rates and charges that may be applicable for FIA provided under other sections of this tariff.

Applies to All Exchanges Illinois

FACILITIES FOR INTRASTATE ACCESS

9. Special Facilities Routing of FIA (Cont'd)

9.2 Rates and Charges

The rates and charges for Special Facilities Routing of FIA are as follows:

9.2.1 Diversity

For each FIA provided in accordance with 9.1.1 preceding, the rates and charges will be developed on an Individual Case Basis and filed following:

(Reserved for Future Use)

9.2.2 Avoidance

For each FIA provided in accordance with 9.1.2 preceding, the rates and charges will be developed on an Individual Case Basis and filed following:

(Reserved for Future Use)

9.2.3 Diversity and Avoidance Combined

For each FIA provided in accordance with 9.1.1 and 9.1.2, combined, the rates and charges will be developed on an Individual Case Basis and are filed following:

(Reserved for Future Use)

9.2.4 Cable-Only Facilities

For each FIA provided in accordance with 9.1.3 preceding, the rates and charges will be developed on an Individual Case Basis and filed following:

(Reserved for Future Use)

Applies to All Exchanges Illinois

FACILITIES FOR INTRASTATE ACCESS

SECTION 10 TABLE OF CONTENTS

<u>10. SPECIAL CONSTRUCTION</u>	<u>Page</u>
10.1 <u>General</u>	3
10.1.1 Conditions Requiring Special Construction.....	3
10.1.2 Filing of Charges.....	3
10.1.3 Ownership of Facilities	4
10.1.4 Interval to Provide FIA	4
10.1.5 Special Construction Involving Interstate and Intrastate FIA.....	5
10.2 <u>Liabilities, Charges and Payments</u>	5
10.2.1 General	5
10.2.2 Payment of Charges	5
10.2.3 Start/End of Billing.....	6
10.2.4 Partial Payments.....	6
10.2.5 Development of Liabilities and Charges.....	6
10.2.6 Types of Contingent Liabilities	7
(A) Maximum Termination Liability	7
(B) Reduction on Maximum Termination Liability	8
10.2.7 Types of Charges	9
(A) Nonrecurring Charges	9
(1) Case Preparation Charge	9
(2) Termination Charge.....	9
(3) Cancellation Charge	10
(4) Expediting Charge.....	10
(5) Optional Payment Charge	10
(a) Development of Optional Payment Charge.....	10
(b) Replacement Charge.....	13
(B) Recurring Charges	14
(1) General	14
(2) Excess Capacity Charge	15
(3) Charge for Route or Type Other Than Normal	17
(4) Lease Charge	20

Applies to All Exchanges Illinois

FACILITIES FOR INTRASTATE ACCESS

SECTION 10 TABLE OF CONTENTS

<u>10. SPECIAL CONSTRUCTION</u>	<u>Page</u>
10.2.8 Application of Charges.....	20
(A) Special Construction of Permanent FIA.....	20
(1) Special Construction When Not Available and There is No Other Requirement for Them.....	20
(2) Special Construction Using a Route or Type of FIA Other Than Normal	21
(3) Special Construction of a Greater Quantity of FIA Than Necessary to Satisfy the Customer's Order for Service	21
(4) Special Construction Expedited at Greater Cost Than Would Otherwise be Incurred	21
(B) Special Construction of Temporary FIA Order.....	21
10.3 <u>Deferral of the In-Service Date of FIA</u>	22
10.3.1 General.....	22
10.3.2 Construction Has Not Started	22
10.3.3 Construction Has Started But is Not Complete.....	22
(A) All FIA Are Deferred	22
(B) Some But Not All FIA are Deferred.....	22
10.3.4 Construction Complete	23
10.4 <u>Charges for Customers Choosing the Optional Liability Period to Provide Permanent FIA Standard</u>	24
10.4.1 Charges	24

Applies to All Exchanges Illinois

FACILITIES FOR INTRASTATE ACCESS

10. SPECIAL CONSTRUCTION

10.1 General

This section contains the regulations, rates and charges applicable for Special Construction of Telephone Company facilities which are used to provide FIA offered under this tariff.

When Special Construction of FIA is required, the provisions of this section apply in addition to regulations, rates and charges set forth in other sections of this tariff.

10.1.1 Conditions Requiring Special Construction

Special Construction is required when facilities are not available to meet a customer's ASR and one or more of the following conditions exist:

- The Telephone Company has no other requirement for the facilities constructed at the customer's request;
- The customer requests that FIA be furnished using a type of facility, or via a route, other than that which the Telephone Company would otherwise utilize in furnishing the requested FIA;
- The customer requests the construction of more facilities than is required to satisfy its ASR;
- The customer requests construction be expedited resulting in added cost to the Telephone Company;
- The customer requests that temporary facilities be constructed until permanent facilities are available.
- The customer requests construction of permanent facilities to be used for temporary Video broadcast service.

10.1.2 Filing of Charges

Charges and liabilities for Special Construction will be filed in 10.4 following.

When Special Construction is required under conditions that preclude the filing of charges in full accordance with the Illinois Commerce Commission Rules and Regulations (e.g., unavailability of cost details, short notice service date):

Applies to All Exchanges Illinois

FACILITIES FOR INTRASTATE ACCESS

10. SPECIAL CONSTRUCTION

10.1 General

10.1.2 Filing of Charges (Cont'd)

- (A) Notification will be made to the Illinois Commerce Commission that Special Construction will be provided in accordance with this tariff.
- (B) After charges have been filed and have become effective they will apply from the date that the Special Construction was provided.
- (C) Charges and/or Maximum Termination Liabilities for Special Construction of facilities provided by a Connecting Carrier are developed by the Connecting Carrier and are filed by the Telephone Company in this tariff on its behalf.
- (D) Regulations and charges for Special Construction of facilities provided by Other Participating Carriers are filed in their tariffs.

10.1.3 Ownership of Facilities

The Telephone Company retains ownership of all specially constructed facilities, except for those facilities constructed by connecting companies or carriers, even though the customer may be required to pay Special Construction charges.

10.1.4 Interval to Provide FIA

Based on available information and the type of FIA ordered, the Telephone Company will establish a scheduled date for the installation of necessary facilities. The date will be established on an Individual Case Basis and provided to the customer. The Telephone Company will make every reasonable effort to assure that the date is met. However, circumstances beyond the Telephone Company's control (e.g., backorder of components) may force a reschedule, and a new completion date will be established with the customer when appropriate.

Applies to All Exchanges Illinois

FACILITIES FOR INTRASTATE ACCESS

10. SPECIAL CONSTRUCTION (Cont'd)

10.1 General (Cont'd)

10.1.5 Special Construction Involving Interstate and Intrastate FIA

When Special Construction involves facilities used to provide both interstate and intrastate FIA, charges for the portion of the construction used to provide intrastate FIA shall be in accordance with this tariff. Charges for the portion of the construction used to provide interstate FIA shall be in accordance with the appropriate FCC tariff.

10.2 Liabilities, Charges and Payments

10.2.1 General

This section describes the various charges and liabilities that apply when the Telephone Company provides Special Construction of FIA, as outlined in 10.1.1 preceding, in accordance with a customer's specific request. Once the customer is notified of all charges and liabilities, the customer must provide the Telephone Company with written approval prior to the start of construction. If more than one condition requiring Special Construction is involved, charges for each condition apply (see Conditions Requiring Special Construction, 10.1.1 preceding).

10.2.2 Payment of Charges

Payment is due upon presentation of a bill for the specially constructed facilities.

Applies to All Exchanges Illinois

FACILITIES FOR INTRASTATE ACCESS

10. SPECIAL CONSTRUCTION (Cont'd)

10.2 Liabilities, Charges and Payments (Cont'd)

10.2.3 Start/End of Billing

Billing of recurring charges for specially constructed FIA starts on the day after the FIA are provided. Billing accrues through and includes the day that the specially constructed FIA are discontinued. Monthly charges will be billed one month in advance.

10.2.4 Partial Payments

The Telephone Company will require a customer which has a proven history of late payments to the Telephone Company, or does not have established credit, to make a partial payment for the portion of the estimated cost of the Special Construction for which the customer is subject to a nonrecurring charge. Partial payments will be requested as costs are incurred and will be credited to the customer's account. Partial payments will not exceed the total nonrecurring charge to the customer for the Special Construction.

10.2.5 Development of Liabilities and Charges

The customer has the option of accepting the liabilities and charges based on estimated or actual costs. Estimated costs will be used unless the customer notifies the Telephone Company of the selection of the actual cost option in writing prior to the start of Special Construction.

Under the estimated cost option, Special Construction liabilities and charges are developed based on estimated costs and will be filed in this tariff.

Under the actual cost option, if all actual costs are not available prior to the in-service date of the FIA, estimated Special Construction charges will be filed in this tariff. As soon as the actual costs, including costs of maintaining and filing these costs, are subsequently determined, the estimated charges will be adjusted to reflect the actual costs. The filed charges will then reflect actual costs existing at the time the FIA are provided.

Applies to All Exchanges Illinois

FACILITIES FOR INTRASTATE ACCESS

10. SPECIAL CONSTRUCTION (Cont'd)

10.2 Liabilities, Charges and Payments (Cont'd)

10.2.6 Type of Contingent Liabilities

Depending on the specifics associated with each individual case, the following Maximum Termination Liability may be applicable for Special Construction.

(A) Maximum Termination Liability

A MTL has two components, an amount and a specified period of time.

The amount is equal to all nonrecoverable costs, less the net salvage value, (e.g., depreciation, return, income tax associated with the specially constructed facilities). The amount will be amortized over the average account life of the specially constructed facilities. The standard liability period is the average account life of the Specially Constructed facilities expressed in years.

Applies to All Exchanges Illinois

FACILITIES FOR INTRASTATE ACCESS

10. SPECIAL CONSTRUCTION (Cont'd)

10.2 Liabilities, Charges and Payments (Cont'd)

10.2.6 Type of Contingent Liability (Cont'd)

(A) Maximum Termination Liability (Cont'd)

At the customer's option, an optional liability period shorter than the average account life may be established. If the customer chooses an optional liability period, the MTL amortization schedule will not change. The remaining MTL amount for the period between the expiration of the optional liability period and the expiration of the amortization schedule will be due as a lump sum payment (LS) at the time the optional liability period expires unless the case of Special Construction is extended.

Prior to the expiration of an optional liability period the customer has the option to (A) extend the use of the specially constructed FIA by establishing a new liability period, or (B) terminate the case of Special Construction and pay the lump sum payment.

The Telephone Company will notify the customer six months in advance of the expiration date of the optional liability period. The customer must provide the Telephone Company with written notification of its intentions to be received one month prior to expiration of the optional liability period. Failure to do so, and payment of the next month's charges, will result in extension of the case of the Special Construction and the establishment of a new liability period equal to the remaining amortization period. A Case Preparation Charge will always apply if the Special Construction case is extended.

The MTL and the liability period applicable to specific cases of Special Construction are as set forth in 10.4 following.

(B) Reduction on Maximum Termination Liability

The time frames for MTL for Special Construction are expressed by an effective date and an expiration date. The MTL will be reduced for each month the Special Construction FIA is in service. For example, if the MTL period is 10 years, for each month in service the MTL would be reduced 1/120th.

Applies to All Exchanges Illinois

FACILITIES FOR INTRASTATE ACCESS

10. SPECIAL CONSTRUCTION (Cont'd)

10.2 Liabilities, Charges and Payments (Cont'd)

10.2.7 Types of Charges

Two categories of charges may be applicable for Special Construction. These charges are nonrecurring charges and recurring charges. These categories are described below.

(A) Nonrecurring Charges

One or more of the following nonrecurring charges may apply for each case of Special Construction: case preparation, termination, cancellation, expediting the construction, or optional payment charges.

(1) Case Preparation Charge

The charge for case preparation includes the administrative expense associated with preparing and listing the charges in the tariff. This expense includes such items as: (a) tariff preparation and processing, and (b) gross receipts taxes and surcharge taxes.

(2) Termination Charge

A Termination Charge applies when, at the customer's request, FIA provided on specially constructed facilities which have a tariffed Maximum Termination Liability are discontinued prior to the expiration of the liability period.

The charge reflects the unamortized portion of the nonrecoverable cost at the time of termination of the specially constructed FIA adjusted for tax effects, for net salvage and for possible reuse. Administrative costs associated with the specific case of Special Construction and any cost for restoring a location to its original condition are also included. Termination Charges will never exceed the MTL.

Applies to All Exchanges Illinois

FACILITIES FOR INTRASTATE ACCESS

10. SPECIAL CONSTRUCTION (Cont'd)

10.2 Liabilities, Charges and Payments (Cont'd)

10.2.7 Types of Charges (Cont'd)

(A) Nonrecurring Charges (Cont'd)

(3) Cancellation Charge

If the customer cancels an ASR with which Special Construction is associated prior to the in-service date of the FIA, a Cancellation Charge will apply. The charge will include all nonrecoverable costs, less the net salvage value, incurred by the Telephone Company up to and including the time of cancellation.

(4) Expediting Charge

An Expediting Charge applies when a customer requests that Special Construction be completed on an expedited basis. The charge is equal to the difference in the estimated cost of construction on an expedited basis and construction without expediting.

(5) Optional Payment Charge

The customer may elect to pay an Optional Payment Charge when it requests Special Construction of facilities utilizing (1) a type of facilities or (2) a route other than that which the Telephone Company would otherwise utilize in furnishing the requested service. Payment of this charge will result in a lower recurring charge for the Special Construction. This election must be made in writing, before Special Construction starts.

If this election is coupled with the actual cost option, the Optional Payment Charge will reflect the actual cost of the specially constructed facilities.

Applies to All Exchanges Illinois

FACILITIES FOR INTRASTATE ACCESS

10. SPECIAL CONSTRUCTION (Cont'd)10.2 Liabilities, Charges and Payments (Cont'd)10.2.7 Types of Charges (Cont'd)(A) Nonrecurring Charges (Cont'd)(5) Optional Payment Charge (Cont'd)(a) Development of Optional Payment Charge

This charge is equal to the excess installed cost or the total nonrecoverable cost, whichever is less, (based on estimated or actual costs as elected by the customer.)

Example 1:

Total Installed Cost	\$30,000
Nonrecoverable	20,000
Normal Installed Cost	17,000

Total Installed Cost	\$30,000
Minus Normal Installed Cost	17,000
Equals Excess Installed Cost	13,000
Optional Payment Charge	13,000

Nonrecoverable Cost	\$20,000
Minus Optional Payment Charge	13,000
Equals Investment for MTL Computation	7,000
Remaining Recoverable Excess Installed Cost	\$0

Since the total installed cost is \$30,000 and the normal installed cost would have been \$17,000, the nonrecurring charge (optional payment) is limited to the difference, (i.e., \$13,000). A Maximum Termination Liability would then be established to protect the remaining nonrecoverable cost of \$7,000 which is the difference between the total nonrecoverable cost (\$20,000) and the nonrecurring charge (\$13,000). The remaining excess installed cost in this example is zero. In addition, a recurring charge will be developed as set forth in 10.2.7 (B) following.

Applies to All Exchanges Illinois

 FACILITIES FOR INTRASTATE ACCESS
10. SPECIAL CONSTRUCTION (Cont'd)10.2 Liabilities, Charges and Payments (Cont'd)10.2.7 Types of Charges (Cont'd)(A) Nonrecurring Charges (Cont'd)(5) Optional Payment Charge (Cont'd)(a) Development of Optional Payment Charge (Cont'd)

Example 2:

Total Installed Cost	\$30,000
Nonrecoverable Cost	10,000
Normal Installed Cost	17,000
Total Installed Cost	\$30,000
Minus Normal Installed Cost	17,000
Equals Excess Installed Cost	13,000
Optional Payment Charge	10,000
Nonrecoverable Cost	\$10,000
Minus Optional Payment Charge	10,000
Equals Investment for MTL Computation	0
Remaining Recoverable Excess Installed Cost	3,000

The Optional Payment Charge is limited to the nonrecoverable cost. In this example the Optional Payment Charge equals the nonrecoverable cost. Therefore, there is no Maximum Termination Liability. In addition, a recurring charge will be developed as set forth in 10.2.7 (B) following.

Applies to All Exchanges Illinois

FACILITIES FOR INTRASTATE ACCESS

10. SPECIAL CONSTRUCTION (Cont'd)10.2 Liabilities, Charges and Payments (Cont'd)10.2.7 Types of Charges (Cont'd)(A) Nonrecurring Charges (Cont'd)(5) Optional Payment Charge (Cont'd)(b) Replacement Charge

If any portion of the specially constructed FIA, for which an Optional Payment Charge has been paid, requires replacement involving capital investment, a charge for replacement will apply. This charge will be in the same ratio as the initial Optional Payment Charge was to the installed cost of the specially constructed FIA. The customer will be notified in writing that the replacement is required. Replacement will not be made without the customer's ASR. If any portion of the FIA subject to the replacement charge fails, the FIA will not be restored until the customer orders the replacement.

Example:

Original Total Installed Cost	\$30,000
Original Optional Payment Charge	\$15,000
Subsequent Cost of Replacement	\$ 2,000

Original Optional Payment Charge x	
<u>Replacement Cost</u>	
Total Installed Cost	

$$\frac{\$15,000 \times \$2,000}{\$30,000} = \$1,000$$

Replacement Charge	\$ 1,000
--------------------	----------

Issued: May 10, 2011

Effective: July 1, 2011

By Kenneth Mason
Vice President
of Government and Regulatory Affairs

Applies to All Exchanges Illinois

FACILITIES FOR INTRASTATE ACCESS

10. SPECIAL CONSTRUCTION (Cont'd)

10.2 Liabilities, Charges and Payments (Cont'd)

10.2.7 Types of Charges (Cont'd)

(B) Recurring Charges

(1) General

- (a) These charges apply on a monthly or annual basis for specially constructed FIA. There are three conditions for which recurring charges apply:
- When a customer requests the construction of more facilities than are necessary to provide the FIA currently ordered.
 - When a customer requests a facility route or type other than that which the Telephone Company would utilize to provide FIA.
 - When a customer's request results in the Telephone Company leasing transmission or other equipment from private vendors to provide FIA (Lease Charge).
- (b) In some cases, the customer may request that the Special Construction nonrecurring charge be amortized over the life of the Special Construction contract. In such cases, the Telephone Company will note the expiration of the recurring charge.

Applies to All Exchanges Illinois

FACILITIES FOR INTRASTATE ACCESS

10. SPECIAL CONSTRUCTION (Cont'd)10.2 Liabilities, Charges and Payments (Cont'd)10.2.7 Types of Charges (Cont'd)(B) Recurring Charges (Cont'd)(2) Excess Capacity Charge

An Excess Capacity Charge applies when the customer requests more facilities be constructed than are required to satisfy the customer's ASR. The charge is based on the estimated cost difference between the facilities constructed at the customer's request and the facilities actually required to meet the customer's ASR.

Example:

A customer has an immediate FIA requirement which would require a 100 pair cable but requests the installation of a 300 pair cable to allow for growth.

Total Installed Cost (300 Pair)	\$2,500
Estimated Annual Cost	\$ 920
Estimated Installed Cost (100 Pair)	\$1,000
Estimated Annual Cost	\$ 368

Excess Recurring Charge: Annually $\$920 - \$368 = \$552$

Monthly $\frac{\$552}{12} = \46

This charge applies until such time as the customer orders sufficient FIA to necessitate use of a larger size cable (e.g., 200 pair cable). At that time the recurring charge is adjusted as indicated in the following example:

Applies to All Exchanges Illinois

FACILITIES FOR INTRASTATE ACCESS

10. SPECIAL CONSTRUCTION (Cont'd)10.2 Liabilities, Charges and Payments (Cont'd)10.2.7 Types of Charges (Cont'd)(B) Recurring Charges (Cont'd)(2) Excess Capacity Charge (Cont'd)

Total Installed Cost (300 Pair)	\$2,500
Estimated Annual Cost	\$ 920
Estimated Installed Cost (200 Pair)	\$1,900
Estimated Annual Cost	\$ 683

Excess Recurring Charge: Annually \$920 - \$683 = \$237

Monthly \$237
12 = \$19.75

The charge is revised in this manner until the number of FIA being provided would require a 300 pair cable, at which time the Excess Capacity Charge is no longer applied. The charge would be reapplied if the number of FIA declined to a level which would not require a 300 pair cable.

Such charges will continue to apply to all facilities held in abeyance until the period of termination liability expires. If facilities are still held in abeyance after the termination liability expires, a new schedule of rates will be calculated and such rates will apply as long as facilities are held in abeyance for the customer.

Applies to All Exchanges Illinois

FACILITIES FOR INTRASTATE ACCESS

10. SPECIAL CONSTRUCTION (Cont'd)10.2 Liabilities, Charges and Payments (Cont'd)10.2.7 Types of Charges (Cont'd)(B) Recurring Charges (Cont'd)(3) Charge for Route or Type Other Than Normal

When the customer requests Special Construction using a route or type of FIA other than that which the Telephone Company would normally use, a recurring charge is applicable. The charge is the difference between the estimated recurring costs of the specially constructed FIA and the estimated recurring costs of the FIA the Telephone Company would normally use. The charge will be no greater than the recurring costs of the specially constructed FIA.

- (a) If the customer elects to pay an Optional Payment Charge, the portion of the recurring charge for the excess investment covered by the optional payment excludes capital cost items (depreciation, return on investment and Federal income tax on that return). The remaining recurring expense cost items associated with the optional payment (maintenance, administration, and other taxes) are increased by a ten percent management fee and will be included in the recurring charge.

The portion of any recurring charge associated with any remaining Special Construction investment will include both capital and expense costs. The ten percent management fee is not applied to this portion of the recurring charge.

Applies to All Exchanges Illinois

FACILITIES FOR INTRASTATE ACCESS

10. SPECIAL CONSTRUCTION (Cont'd)

10.2 Liabilities, Charges and Payments (Cont'd)

10.2.7 Types of Charges (Cont'd)

(B) Recurring Charges (Cont'd)

(3) Charge for Route or Type Other Than Normal (Cont'd)

(a) (Cont'd)

DEVELOPMENT OF RECURRING MONTHLY CHARGE FOR OPTIONAL PAYMENTS

	<u>SPECIAL ROUTE OR TYPE FIA</u>		<u>NORMAL</u>	
	A	B	C	D
Optional Payment				
Nonrecurring Charge For Special Const.	FIA	Specially Constructed FIA Less Nonrecurring Charges	Normal Existing Facilities	Route/Type Facilities
	<u>\$13,000</u>	<u>\$17,000</u>		<u>\$17,000</u>
1. Depreciation	-	1,122		408
2. Federal Income Tax and Return	-	2,142		2,346
3. Maintenance	1,131	1,479		799
4. Administration	455	595		595
5. Other Taxes	286	37		374
6. Sub Total	1,872	-	-	-
7. 10% x Line 6	187	-	-	-
8. Totals	(A) \$2,059	(B) \$5,712	(C)	(D) \$4,522

A + B = \$7,771

A + B + C = 7,771

(A + B + C) - D = 3,249

Excess Recurring Charge:* Annually \$3,249.00 Monthly \$ 270.75

*The lower of (A+B+C)-D, or (A+B)

Applies to All Exchanges Illinois

FACILITIES FOR INTRASTATE ACCESS

10. SPECIAL CONSTRUCTION (Cont'd)

10.2 Liabilities, Charges and Payments (Cont'd)

10.2.7 Types of Charges (Cont'd)

(B) Recurring Charges (Cont'd)

(3) Charge for Route or Type Other Than Normal (Cont'd)

(a) (Cont'd)

DEVELOPMENT OF RECURRING MONTHLY CHARGE FOR OPTIONAL PAYMENTS

	<u>SPECIAL ROUTE OR TYPE FIA</u>		<u>NORMAL</u>	
	A	B	C	D
Optional Payment				
Nonrecurring Charge For Special Const.	FIA	Specially Constructed Less Nonrecurring Charges	Existing Facilities	Normal Route/Type Facilities
	\$10,000	\$20,000		\$17,000
1. Depreciation	-	\$1,320		408
2. Federal Income Tax and Return	-	2,520		2,346
3. Maintenance	870	1,740		799
4. Administration	350	700		595
5. Other Taxes	220	440		374
6. Sub Total	1,440	-	-	-
7. 10% x Line 6	144	-	-	-
8. Totals	(A) \$ 1,584	(B) \$ 6,720	(C)	(D) \$ 4,522

A + B = \$8,304 A + B + C = 8,304 (A + B + C) - D = 3,782

Excess Recurring Charge:* Annually \$3,782.00 Monthly \$ 315.17

*The lower of (A+B+C)-D, or (A+B)

Applies to All Exchanges Illinois

FACILITIES FOR INTRASTATE ACCESS

10. SPECIAL CONSTRUCTION (Cont'd)

10.2 Liabilities, Charges and Payments (Cont'd)

10.2.7 Types of Charges (Cont'd)

(B) Recurring Charges (Cont'd)

(3) Charge for Route or Type Other Than Normal (Cont'd)

- (b) If the customer has elected the actual cost option, the recurring charge will be adjusted to reflect the actual cost of the new construction when the cost is determined. This adjusted recurring charge is applicable from the start of FIA.

(4) Lease Charge

A Lease Charge applies when the Telephone Company leases equipment, (e.g., portable microwave equipment) in order to provide FIA to meet the customer's requirements. The amount of the charge is the net added cost to the Telephone Company caused by the lease.

10.2.8 Application of Charges

The charges for Special Construction are those charges which are in effect for the period that the Special Construction is furnished. If the charges for a period covered by a bill change after the bill has been rendered, the bill will be adjusted to reflect the new charges. Charges are based on Special Construction of (A) permanent FIA or (B) temporary FIA.

(A) Special Construction of Permanent FIA

(1) Special Construction When Not Available and There is No Other Requirement for Them

When permanent FIA are not available and the Telephone Company constructs them and there is no other Telephone Company need for the specially constructed FIA, a nonrecurring charge, and a Maximum Termination Liability may be applicable.

Applies to All Exchanges Illinois

FACILITIES FOR INTRASTATE ACCESS

10. SPECIAL CONSTRUCTION (Cont'd)

10.2 Liabilities, Charges and Payments (Cont'd)

10.2.8 Application of Charges (Cont'd)

(A) Special Construction of Permanent FIA (Cont'd)

(2) Special Construction Using a Route or Type of FIA Other Than Normal

When the specially constructed FIA involves a route or type of FIA other than that which the Telephone Company would ordinarily use, charges are based on the difference between the estimated costs of the specially constructed FIA and those the Telephone Company would ordinarily use. A nonrecurring charge, a recurring charge, and a Maximum Termination Liability may be applicable.

(3) Special Construction of a Greater Quantity of FIA Than Necessary to Satisfy the Customer's Order for Service

When the Telephone Company constructs more FIA than is required to satisfy the customer's ASR, additional charges will apply. These charges may include a nonrecurring charge, a recurring charge, and a Maximum Termination Liability.

(4) Special Construction Expedited at Greater Cost Than Would Otherwise be Incurred

When construction is expedited resulting in added costs, a nonrecurring Expediting Charge applies.

(B) Special Construction of Temporary FIA Order

When permanent FIA are not available and temporary FIA are constructed pending the construction of permanent FIA, a nonrecurring charge, and a Maximum Termination Liability may be applicable.

Applies to All Exchanges Illinois

FACILITIES FOR INTRASTATE ACCESS

10. SPECIAL CONSTRUCTION (Cont'd)

10.3 Deferral of the In-Service Date of FIA

10.3.1 General

The customer may request the Telephone Company to defer the in-service date of FIA on specially constructed FIA subject to the provisions as set forth in 3.2.2(B) preceding. If the deferral is not in compliance with the provisions as set forth in 3.2.2(A), the Special Construction case is considered to be cancelled and cancellation charges apply. Requests for deferral must be in writing and are subject to the following regulations.

10.3.2 Construction Has Not Started

If the Telephone Company has not incurred any costs (e.g., engineering and/or installation) before receiving the customer's request for deferral, no charge applies other than the Case Preparation Charge. However, the original quotation is subject to Telephone Company review at the time of reinstatement to determine if the original charges are still valid. Any change in liabilities and charges requires the concurrence of the customer in writing. Additional Case Preparation Charges will also apply.

10.3.3 Construction Has Started But Is Not Complete

If the construction of FIA has started, but has not been completed, before the Telephone Company receives the customer request for deferral, charges apply. The charges vary depending on whether all or some of the FIA ordered are deferred.

(A) All FIA Are Deferred

When all FIA involving Special Construction are deferred, a charge equal to the costs incurred during each month of the deferral applies. Those costs include the recurring costs for that portion of the FIA already completed and any other costs associated with the deferral. The Case Preparation Charge also applies.

(B) Some But Not All FIA are Deferred

When some, but not all, FIA utilizing the specially constructed FIA are deferred, the Special Construction case will be completed. Maximum Termination Liability will apply in addition to Case Preparation Charges and any recurring charges associated with the Special Construction.

Applies to All Exchanges Illinois

FACILITIES FOR INTRASTATE ACCESS

10. SPECIAL CONSTRUCTION (Cont'd)

10.3 Deferral of the In-Service Date of FIA

10.3.4 Construction Complete

If the construction of FIA has been completed before the Telephone Company receives the customer's request for deferral, the Case Preparation Charge, as originally determined, will apply and any recurring charges associated with the Special Construction. The maximum termination liability period will begin when the customer accepts the service.

Applies to All Exchanges Illinois

FACILITIES FOR INTRASTATE ACCESS

10. SPECIAL CONSTRUCTION (Cont'd)10.4 Charges for Customers Choosing the Standard Liability Period to Provide Permanent FIA

This section contains the Special Construction charges to provide permanent FIA to individual customers. Charges are developed on an Individual Case Basis for a specific customer and filed in this section.

10.4.1 Charges

<u>Customer Name / Effective Date</u>	<u>Description and Location</u>	<u>MTL/NRC MRC/LS</u>	<u>Telco</u>	<u>Expiration Date</u>
Rantoul Products Inc. ID# IL02-01236	Special Construction for DS3 facility between 707 Veterans Parkway, Rantoul, IL and 300 Shellhouse Drive, Rantoul, IL	NRC: \$15,151.00	Frontier North Inc.	-
Affiliated Computer Services, Inc. ID#2002-219458 / 4-7-03	Special Construction for DS1 diversity with dual entrances at Ingersoll Rand 121 W. Railroad Ave. Princeton, IL	MRC: \$440.00 NRC: \$5,694.00	Frontier North Inc.	6-15-08
Pella Corporation	Special Construction of primary and secondary route to facilities at 111 Pella Place, Macomb, IL, for support of DS1 service	NRC: \$18,034.35	Frontier North Inc.	-
Pella Corporation ID#2005-347661	Special Construction of secondary route to facilities at 111 Pella Place, Macomb, IL, to support service	NRC: \$59,743.06	Frontier North Inc.	-

Issued: May 10, 2011

Effective: July 1, 2011

By Kenneth Mason
Vice President
of Government and Regulatory Affairs

Applies to All Exchanges Illinois

FACILITIES FOR INTRASTATE ACCESS

SECTION 11 TABLE OF CONTENTS

<u>11. SPECIAL FEDERAL GOVERNMENT FIA</u>	<u>Page</u>
11.1 <u>General</u>	2
11.2 <u>Emergency Conditions</u>	2
11.3 <u>Intervals to Provide FIA</u>	3
11.4 <u>Safeguarding of FIA</u>	3
11.4.1 <u>FIA Availability</u>	3
11.5 <u>Federal Government Regulations</u>	4
11.6 <u>FIA Offerings to the Federal Government</u>	4
11.6.1 <u>Type and Description</u>	4
(A) <u>Voiceband Special Access</u>	4
(1) <u>Voice Grade Secure Communications Type I</u>	4
(2) <u>Voice Grade Secure Communications Type II</u>	6
(3) <u>Voice Grade Secure Communications Type III</u>	6
(4) <u>Voice Grade Secure Communications Type IV</u>	7
(B) <u>Special Wideband Digital Special Access</u>	7
(1) <u>Wideband Secure Communications Type I</u>	7
(2) <u>Wideband Secure Communications Type II</u>	7
(3) <u>Wideband Secure Communications Type III</u>	7
(C) <u>Federal Payment Plan (FPP)-DS1/DDS/Four-Wire Voiceband/DS3</u>	8
(D) <u>Switched Data Service</u>	12
11.6.2 <u>Mileage Application</u>	14
11.6.3 <u>Rates and Charges</u>	14

Issued: May 10, 2011

Effective: July 1, 2011

By Kenneth Mason
 Vice President
 of Government and Regulatory Affairs

Applies to All Exchanges Illinois

FACILITIES FOR INTRASTATE ACCESS

11. SPECIAL FEDERAL GOVERNMENT FIA

11.1 General

This section covers FIA that are provided for use only by agencies or branches of the Federal Government and other users authorized by the Federal Government. FIA provided to state emergency operations centers are included. These FIA provide for command and control communications, including communications for national security, emergency preparedness and presidential requirements. They are required to assure continuity of Government in emergency and crisis situations and to provide for national security.

FIA for command and control communications and for national security and emergency preparedness are sometimes required within a short timeframe. These provisions are especially needed to meet presidential requirements or in response to natural, man made, or declared emergencies. Requirements of this type cannot be forecasted and are usually needed for a relatively short period. The provision of FIA under these conditions may require the availability of facilities, such as portable microwave equipment, etc., which are provided on a temporary basis.

11.2 Emergency Conditions

These FIA will be provided on the date requested or as soon as possible thereafter when the emergency falls into one of the following categories:

State of crisis declared by the National Command Authorities (includes commitments made to the National Communications System in the "National Plan for Emergencies and Major Disasters").

Efforts to protect endangered U.S. personnel or property both in the U.S. and abroad (includes space vehicle recovery and protection efforts).

Communications requirements resulting from hostile action, a major disaster or a major civil disturbance.

The Director (Cabinet level) of a Federal Department, Commander of a Unified/Specified Command, or Head of a Military Department has certified that a communications requirement is so critical to the protection of life and property or to the National Defense that it must be processed immediately.

Applies to All Exchanges Illinois

FACILITIES FOR INTRASTATE ACCESS

11. SPECIAL FEDERAL GOVERNMENT FIA

11.2 Emergency Conditions (Cont'd)

Political unrest in foreign countries which affect the National Interest.

Presidential Service.

11.3 Intervals to Provide FIA

ASRs may be placed under the provisions set forth in 3.2.1 preceding.

11.4 Safeguarding of FIA

11.4.1 FIA Availability

In order to insure communications during periods of emergency, the Telephone Company will (within the limits of good management) make available the necessary facilities to restore FIA in the event of damage or to provide temporary emergency FIA.

In order to meet the requirements of agencies or branches of the Federal Government, the Telephone Company may utilize government-owned facilities, when necessary, to provide FIA.

Applies to All Exchanges Illinois

FACILITIES FOR INTRASTATE ACCESS

11. SPECIAL FEDERAL GOVERNMENT FIA

11.5 Federal Government Regulations

FIA provided to the Federal Government will be billed in arrears, as required by Federal procurement or disbursement regulations, or as established by law. ICs providing service to the Federal Government are not entitled to the benefits of those laws or regulations providing for billing the Federal Government in arrears.

11.6 FIA Offerings to the Federal Government

The following FIA are provided only for agencies or branches of the Federal Government. Access Services provided to the Federal Government but not specified in the following will be provided in accordance with the regulations and at the rates contained in other sections of this tariff.

11.6.1 Type and Description

(A) Voiceband Special Access

(1) Voice Grade Secure Communications Type I

Approximate bandwidth of 10-50000 Hz. Furnished for two-point secure communications on two-wire or four-wire metallic facilities between two or more customer designated locations and an end user's premises. Special Access is conditioned as follows:

Applies to All Exchanges Illinois

FACILITIES FOR INTRASTATE ACCESS

11. SPECIAL FEDERAL GOVERNMENT FIA

11.6 FIA Offerings to the Federal Government (Cont'd)

11.6.1 Type and Description (Cont'd)

(A) Voiceband Special Access (Cont'd)

(1) Voice Grade Secure Communications Type I (Cont'd)

T-3 Conditioning - The absolute loss (referenced to one milliwatt) with respect to frequency shall not exceed:

15 dB at 10 Hz
13 dB at 100 Hz
12 dB at 1000 Hz
20 dB at 10000 Hz
30 dB at 50000 Hz

Additional conditioning (available in one or two directions on four-wire facilities only) to provide the following characteristics:

The absolute loss (referenced to one milliwatt) with respect to frequency shall not exceed:

0 dB at 1000 Hz
 ± 1 dB between 1000 Hz and 40000 Hz
 ± 2 dB between 10 Hz and 50000 Hz (+ means more loss)

The net loss of the conditioned Special Access (with or without additional conditioning) shall not vary by more than 4 dB at 1000 Hz from the levels specified above. Voice frequency signaling or supervisory tones can be transmitted.

Applies to All Exchanges Illinois

FACILITIES FOR INTRASTATE ACCESS

11. SPECIAL FEDERAL GOVERNMENT FIA

11.6 FIA Offerings to the Federal Government (Cont'd)

11.6.1 Type and Description (Cont'd)

(A) Voiceband Special Access (Cont'd)

(2) Voice Grade Secure Communications Type II

Approximate bandwidth 10-50000 Hz. Furnished on four-wire metallic facilities for duplex operation for two-point secure communication between a customer designated location and an end user's premises. Special Access is conditioned as follows:

G-1 Conditioning - The absolute loss with respect to frequency and the net loss variation shall be the same as Voice Grade Secure Communications Type I Special Access without additional conditioning. Voice frequency signaling or supervisory tones can be transmitted.

(3) Voice Grade Secure Communications Type III

Approximate bandwidth 10-50000 Hz. Furnished on four-wire metallic facilities for duplex operation for two-point secure communication between a customer designated location and an end user's premises. Special Access is conditioned as follows: G-2 Conditioning - The absolute loss with respect to frequency and the net loss variation from the customer designated location to the end user's premises shall be the same as Voice Grade Secure Communications Type I, Special Access without additional conditioning; and from the end user's premises to the customer designated location shall be the same as Voice Grade Secure Communications Type I Special Access with additional conditioning. Voice frequency signaling or supervisory tones can be transmitted.

Applies to All Exchanges Illinois

FACILITIES FOR INTRASTATE ACCESS

11. SPECIAL FEDERAL GOVERNMENT FIA (Cont'd)

11.6 FIA Offerings to the Federal Government (Cont'd)

11.6.1 Type and Description (Cont'd)

(A) Voiceband Special Access (Cont'd)

(4) Voice Grade Secure Communications Type IV

Approximate bandwidth 10-50000 Hz. Furnished on four-wire metallic facilities for duplex operations for two-point secure communications between two customer designated locations. Special Access is conditioned as follows:

G-3 Conditioning - The absolute loss with respect to frequency and the net loss variation shall be the same in both directions of transmission as Voice Grade Secure Communications Type I Special Access with additional conditioning. Voice frequency signaling or supervisory tones can be transmitted.

(B) Special Wideband Digital Special Access

Special Access arrangements for secured communications to accommodate the transmission of binary digital baseband signals in a random polar format.

(1) Wideband Secure Communications Type I

For transmission at the rate of 18,750 bits per second.

(2) Wideband Secure Communications Type II

For transmission at the rate of 50,000 bits per second.

(3) Wideband Secure Communications Type III

To accommodate the transmission of restored polar two-level facsimile signals with a minimum signal element width of 20 microseconds at a rate of 50,000 bits per second.

To accommodate the transmission of binary digital baseband signals in a random polar format at the rate of 50,000 bits per second.

Applies to All Exchanges Illinois

FACILITIES FOR INTRASTATE ACCESS

11. SPECIAL FEDERAL GOVERNMENT FIA (Cont'd)

11.6 FIA Offerings to the Federal Government (Cont'd)

11.6.1 Type and Description (Cont'd)

(C) Federal Payment Plan (FPP) - DS1/DDS/Four-Wire Voiceband/DS3

(1) Description

The Federal Payment Plan (FPP) - DS1, DDS, Four-Wire Voiceband or DS3 Service will be provided to the Federal Government or any customer awarded a contract, with a minimum three year period, to provide telecommunications service(s) for the exclusive use of the Federal Government and its authorized agents. The FPP will allow each of the Federal Government's authorized customers providing network services under contract to obtain DS1, DDS, Four-Wire Voiceband and DS3 SALs at rates contained in this section. FPP DS3 Services will be filed on an Individual Case Basis (ICB). In addition to the specific terms and conditions of this plan, all other regulations in Section 5 pertaining to DS1, DDS, Four-Wire Voiceband and DS3 Services are applicable. For Special Transport associated with DDS and Four-Wire voiceband FPP services, the RSP monthly recurring charges set forth under Section 5.7.16(A) will apply, as follows: For a three year FPP term, the three year RSP transport rate is applicable. For either the five year or six to fifteen year terms, the five year RSP transport rate will apply. All other associated rate elements or additional features are available at the tariffed rates and regulations. Special construction may apply as specified in Section 10.

(2) FPP Enrollment

At enrollment, unless the customer of record is the Federal Government, will provide in writing, a description of the Federal Government contract, a forecast of services desired, and a term ending date which may be three years, five years, or six years not to exceed 15 years. If the option of six to fifteen years is chosen, the ending date must be the same as the government contract ending date.

Applies to All Exchanges Illinois

FACILITIES FOR INTRASTATE ACCESS

11. SPECIAL FEDERAL GOVERNMENT FIA (Cont'd)

11.6 FIA Offerings to the Federal Government (Cont'd)

11.6.1 Type and Description (Cont'd)

(C) Federal Payment Plan (FPP) - DS1/DDS/Four-Wire Voiceband/DS3 (Cont'd)

(3) Adding Services to the Plan

Except for FPP DS3 Service which is provided on an ICB basis, the customer may add DS1, DDS or Four-Wire Voiceband services to the plan at any time during the term of the FPP. The services added will have the same term ending date.

(4) Rebid Provision

If as a result of a Federal Government contract rebid provision any DS1, DDS or Four-Wire Voiceband services under an FPP are discontinued by the customer as a direct result of the rebid process, termination liabilities will not apply.

(5) Mandated Site Closing

If, as a result of a Federal Government mandated site closing, any DS1, DDS, Four-Wire Voiceband or DS3 Services under the FPP are discontinued, termination liabilities will not apply.

(6) CDL Change

In the case where the government agency(s) at a current CDL chooses or is ordered to move to a new CDL, and the new CDL requires the same or more DS1, DDS or Four-Wire Voiceband services, no termination liabilities will apply.

Applies to All Exchanges Illinois

FACILITIES FOR INTRASTATE ACCESS

11. SPECIAL FEDERAL GOVERNMENT FIA (Cont'd)11.6 FIA Offerings to the Federal Government (Cont'd)11.6.1 Type and Description (Cont'd)(C) Federal Payment Plan (FPP) - DS1/DDS/Four-Wire Voiceband/DS3 (Cont'd)(7) Change in Term

Should the Federal Government extend their contract and the customer wants to extend the FPP to match the new contract, the customer shall provide written notice to the Telephone Company. The Telephone Company will extend the ending date to match the new contract date. If the term ends and the customer does not provide us with a new ending date within 90 days, the rates will be converted to the standard month-to-month rates. The same term originally established will be used when applying rates unless the customer qualifies for longer term rates based on the remaining life of the term.

(8) Multiple Contracts

Each customer that has contracts with the Federal Government may have multiple contracts and a different ending date for each Federal Government contract.

(9) Upgrade to Higher Speed Service

The customer may choose to upgrade service to a higher speed during the FPP period. The upgraded service will be subject to all appropriate NRCs. If the term selected for the higher speed service extends for a longer period than the remaining time of the FPP or seven years if there is more than seven years remaining on the FPP, no termination liabilities will apply.

Applies to All Exchanges Illinois

FACILITIES FOR INTRASTATE ACCESS

11. SPECIAL FEDERAL GOVERNMENT FIA (Cont'd)11.6 FIA Offerings to the Federal Government (Cont'd)11.6.1 Type and Description (Cont'd)(C) Federal Payment Plan (FPP) - DS1/DDS/Four-Wire Voiceband/DS3 (Cont'd)(10) Termination Liabilities

Except for FPP DS3 Service, when an FPP service is discontinued prior to the end of the period, termination liability charges will apply based on the remainder of FPP period and the date of the disconnect. The termination liability rates shall be as follows:

<u>Year in Which Service is Discontinued</u>	<u>Liability Rate</u>
1 – 3	20%
4 – 15	10%

(11) NRCs

There will be no nonrecurring charges for DS1 SALs ordered for FPP Services; however, nonrecurring charges in Section 5 pertaining to DDS and Four-Wire Voiceband services will apply for installation of new DDS and Four-Wire Voiceband SALs.

(12) Rate Changes

The FPP rates will be at or below the Term Payment Plan (TPP) rates if TPP is available in Section 5. The 6 to 15 year FPP rate will be less than the 5 year FPP rate.

Applies to All Exchanges Illinois

FACILITIES FOR INTRASTATE ACCESS

11. SPECIAL FEDERAL GOVERNMENT FIA (Cont'd)

11.6 FIA Offerings to the Federal Government (Cont'd)

11.6.1 Type and Description (Cont'd)

(D) Switched Data Service (Cont'd)

(1) Switched 56

This option provides for a connection capable of up to 56 Kbps digital transmission between the customer's CDL and a technically capable end office. Switched Data Service lines connected at those technically capable end offices will be accessed on a switched basis for digital transmission up to 56 Kbps. These locations are identified in the National Exchange Carrier Association, Inc., Tariff FCC No. 4 Wire Center and Interconnection Information.

This option is provided only with FGD or BSA-D as set forth in Section 4. This trunk group requires the use of a DS1 digital interface as described in Section 4.2.3(B)(6).

Access is made via the standard dialing pattern as set forth in Section 4.2.1(D)(8) and 4.2.2(D)(8).

Applies to All Exchanges Illinois

FACILITIES FOR INTRASTATE ACCESS

11. SPECIAL FEDERAL GOVERNMENT FIA (Cont'd)

11.6 FIA Offerings to the Federal Government (Cont'd)

11.6.1 Type and Description (Cont'd)

(D) Switched Data Service (Cont'd)

(2) Switched 64

This option provides for a connection capable of up to 64 Kbps digital transmission with clear channel capability between the customer's CDL and a technically capable end office. Clear Channel Capability allows for full bandwidth availability to the customer with no part of the channel used for control, framing or signaling.

Switched 64 requires all digital facility including the use of a DS1 digital interface as described in Section 4.2.3(B)(6) and is available only with FGD or BSA-D, as set forth in Section 4, from end offices capable of providing SS7 signaling, Bipolar with Eight Zero Substitution (B8ZS) line code format and Integrated Services Digital Network (ISDN) or other Switched Data based services. These locations are identified in the National Exchange Carrier Association, Inc., Tariff FCC No. 4 Wire Center and Interconnection Information.

Access is made via the standard dialing pattern as set forth in Section 4.2.1(D)(8) and 4.2.2(D)(8).

Applies to All Exchanges Illinois

FACILITIES FOR INTRASTATE ACCESS

11. SPECIAL FEDERAL GOVERNMENT FIA (Cont'd)11.6 FIA Offerings to the Federal Government (Cont'd)11.6.2 Mileage Application

Mileage for rate application is the airline distance measured between the two related Special Access terminating points (i.e., customer designated location and end user premises).

11.6.3 Rates and Charges

Notification will be made to the Illinois Commerce Commission that Special Federal Government FIA will be provided in accordance with Special Permission No. 83-867.

(A) Voiceband Special Access

The provision of T-3 and G conditioned Special Access contemplates station and tandem switching operations using customer provided equipment, as well as Special Access. Separate narrowband or voice grade Special Access, where required by the customer provided equipment or switching operation, are furnished in accordance with the applicable sections of this tariff.

<u>Voice Grade Secure Communications</u>	<u>Monthly Nonrecurring Termination Rates Charges Charges</u>
Type I, each T-3 Conditioning	ICB rates and charges apply
Additional Conditioning, per Special Access termination	ICB rates and charges apply
Type II, each G-1 Conditioning	ICB rates and charges apply
Type III, each G-2 Conditioning	ICB rates and charges apply
Additional Conditioning, per Special Access termination	ICB rates and charges apply
Type IV, each G-3 Conditioning	ICB rates and charges apply
Additional Conditioning, per Special Access termination	ICB rates and charges apply

Applies to All Exchanges Illinois

FACILITIES FOR INTRASTATE ACCESS

11. SPECIAL FEDERAL GOVERNMENT FIA (Cont'd)11.6 FIA Offerings to the Federal Government (Cont'd)11.6.3 Rates and Charges (Cont'd)(B) Special Wideband Digital Special Access

<u>Wideband Secure Communications</u>	<u>Monthly Nonrecurring Termination</u>		
	<u>Rates</u>	<u>Charges</u>	<u>Charges</u>
Type I, each		ICB rates and charges apply	
Type II, each		ICB rates and charges apply	
Type III, each		ICB rates and charges apply	

(C) Federal Payment Plan (FPP) - DS1/DDS/Four-Wire Voiceband
Each Special Access Line

	<u>Three Year Monthly Rate</u>	<u>Five Year Monthly Rate</u>	<u>Six to Fifteen Year Monthly Rate</u>
(1) DS1 Service	160.00	\$140.00	\$115.00
(2) DDS Service			
(a) 2.4, 4.8, 9.6, 19.2 Kbps	\$ 52.25	\$ 49.50	\$ 49.00
(b) 56, 64 Kbps	64.60	61.20	60.50
(3) Four-Wire Voice	\$ 28.15	\$ 26.67	\$ 26.58

(D) Move Charges

When a Special Access requiring T-3 conditioning, T-3 additional conditioning, or a Special Access requiring G conditioning as set forth in (A) preceding, is moved to a different building, the nonrecurring charge applies; when moved to a new location in the same building, a charge of one-half the nonrecurring charge applies.

When any FIA for which a termination charge is specified is moved and is installed at a new location the customer may elect:

Applies to All Exchanges Illinois

FACILITIES FOR INTRASTATE ACCESS

11. SPECIAL FEDERAL GOVERNMENT FIA (Cont'd)

11.6 FIA Offerings to the Federal Government (Cont'd)

11.6.3 Rates and Charges (Cont'd)

(D) Move Charges (Cont'd)

- (1) to pay the unexpired portion of the termination charge for the FIA, if any, with the application of a nonrecurring charge and the establishment of a new termination charge for such FIA at the new location, or
- (2) to continue the FIA subject to the unexpired portion of the termination charge, if any, and pay the estimated costs of moving such FIA, provided that the customer requests these charges be quoted prior to ordering the FIA move. Charges for moving such FIA will be based on estimated costs attributable to the move.

Move charges include the estimated costs of removal, restoration of FIA necessitated by the move, transportation, storage, reinstallation, engineering, labor, supervision, materials, administration, taxes, and any other specific items of cost directly attributable to the move.

(E) High Capacity DS1 Service

For Special Federal Government access arrangements, High Capacity DS1 SALs will be rated as set forth in this tariff but will be offered with Clear Channel Capability as a nonchargeable option. Clear Channel Capability is described in 5.8.1.

Applies to All Exchanges Illinois

FACILITIES FOR INTRASTATE ACCESS

SECTION 12 TABLE OF CONTENTS

<u>12. PRIMARY INTEREXCHANGE CARRIER CHARGE (PICC)</u>	<u>PAGE</u>
12.1 General.....	2
12.2 Rates and Charges	2

Applies to All Exchanges Illinois

FACILITIES FOR INTRASTATE ACCESS

12. PRIMARY INTEREXCHANGE CARRIER CHARGE (PICC)

12.1 General

The Primary Interexchange Carrier charges (PICC) compensate the Telephone Company for Telephone Company provided common lines for access to end users.

The PICC is a flat-rated charge assessed on the end user's presubscribed carrier. End user customers who do not select a presubscribed carrier will be billed the PICC.

The PICC will not be reduced for residential Lifeline customers.

The PICC will be waived for residential Lifeline customers who are toll blocked.

12.2 Rates and Charges

	<u>RATE</u>
Monthly Rate, Per Presubscribed Primary Residence and Single Line Business Line	\$0.00
Monthly Rate, Per Presubscribed Multiline Business Line	0.00
Monthly Rate, Per Presubscribed ISDN-BRI Line and Non-Primary Residence Line	0.00
Monthly Rate, Per Presubscribed ISDN-PRI Arrangement	0.00
Monthly Rate, Centrex, Per Line	0.00

Issued: May 10, 2011

Effective: July 1, 2011

By Kenneth Mason
Vice President
of Government and Regulatory Affairs

Applies to All Exchanges Illinois

FACILITIES FOR INTRASTATE ACCESS

SECTION 13 TABLE OF CONTENTS

<u>13. VIDEO DIGITAL TRANSPORT SERVICE</u>	<u>PAGE</u>
13.1 <u>General</u>	2
13.2 <u>Abbreviations</u>	2
13.3 <u>Description</u>	2
13.4 <u>Regulations</u>	9
13.5 <u>General Rate Regulations</u>	17
13.6 <u>Rates and Charges</u>	19

Applies to All Exchanges Illinois

FACILITIES FOR INTRASTATE ACCESS

13. VIDEO DIGITAL TRANSPORT SERVICE

13.1 General

This Tariff section contains the description, regulations, and rates applicable to Video Digital Transport Service furnished by the Company where facilities permit.

13.2 Abbreviations

ATM	- Asynchronous Transfer Mode
Codec	- Video Coder Decoder
DCC	- Digital Cross Connect
Kbps	- Kilobits per second
Mbps	- Megabits per second
MCU	- Video Multipoint Control Unit
MRC	- Monthly Recurring Charge
NRC	- Non-Recurring Charge
NTSC	- National Television Systems Committee
SPOT	- Switched Point of Termination
VCAL	- Video Digital Transport Service Access Line

13.3 Description

Video Digital Transport Service is the movement, management, and control of moving pictures or video frames of information along with associated audio.

Video Digital Transport Service is available in several transmission/quality levels which correspond to varying customer requirements for video services. These are:

Broadcast Quality
Commercial Quality
Business Quality

Applies to All Exchanges Illinois

FACILITIES FOR INTRASTATE ACCESS

13. VIDEO DIGITAL TRANSPORT SERVICE (Cont'd)

13.3 Description (Cont'd)

13.3.1 Broadcast Quality

Video Digital Transport Service Broadcast Quality provides transmission capability which supports a picture quality that meets or exceeds performance requirements for 525 line/60 field monochrome, or National Television Systems Committee (NTSC) color video signals. Video Digital Transport Service Broadcast Quality transmits from one to four associated audio signals along with the video signal. Customers may select channel interface options to meet their specific requirements. Video Digital Transport Service Broadcast Quality may employ two types of network facilities to complete the customer circuit. These two types of facilities are referred to as Type I and Type II in this tariff. Type II facilities are digital from the customer designated premises throughout the Company's network of wire centers and digital video hubs. Type I facilities are analog from the customer designated premises and throughout the Company's network facilities. Type II service uses high quality Codecs with a digital interface of 44.736 Mbps to support NTSC baseband video along with up to four associated audio channels with 15 KHz bandwidth. Because there is no industry standard algorithm for digital encoding Video Digital Transport Service Broadcast Quality Type II television signals the receive codec must decode the proprietary algorithm used by the transmit codec. Although Type I service uses high quality analog transmit and receive units instead of digital ones, the lack of industry standards still requires that units on each end of the video path be compatible with each other's proprietary signaling algorithms. Type I service includes two audio channels with up to 15 KHz bandwidth.

13.3.2 Commercial Quality

Video Digital Transport Service Commercial Quality provides for transmission facilities which support a picture quality that is near the performance requirements of NTSC video but is not of as high a quality as Broadcast Quality video. A Video Digital Transport Service Commercial Quality may employ one of two types of network facilities to complete the customer circuit. Type II service employs high quality codecs with a digital interface of 44.736 Mbps and digital network facilities from customer designated premises and throughout the Company's network of wire centers and digital video hubs to support the video signals and up to four audio channels with 15 KHz bandwidth.

Applies to All Exchanges Illinois

FACILITIES FOR INTRASTATE ACCESS

13. VIDEO DIGITAL TRANSPORT SERVICE (Cont'd)

13.3 Description (Cont'd)

13.3.3 Business Quality

Video Digital Transport Service Business Quality provides transmission facilities which utilize compressed video transmission techniques capable of transmitting good picture quality. A single audio channel with a frequency response to 7 Khz is provided with each video circuit. Video Digital Transport Service Business Quality video is suitable for teleconferencing between two geographically separate locations. Video Digital Transport Service Business Quality video is offered as Type II service which utilizes digital facilities to provide two-way, two-point service. Type II service uses a transmission bandwidth of 1.544 Mbps to support a picture quality that is visually comparable to commercial quality video, but has less stringent technical parameters.

13.3.4 Customer Provided Equipment

By subscription to a Video Access Line the customer is provided with circuit equipment and outside plant facilities from the serving wire center to the customer's designated location and a codec at the designated location. The codec is the demarcation point between the Telephone Company's network and customer premises equipment. The customer must provide all customer premises equipment at each end of the network, such as cameras, monitors, audio and graphics equipment.

13.3.5 Rate Elements

The Video Digital Transport Service is composed of the following basic rate elements:

- Video Digital Transport Service Access Line
- Video Digital Transport Service Access Port
- Video Digital Transport Service Utilization
- Video Digital Transport Service Premium Services

Applies to All Exchanges Illinois

FACILITIES FOR INTRASTATE ACCESS

13. VIDEO DIGITAL TRANSPORT SERVICE (Cont'd)

13.3 Description (Cont'd)

13.3.5 Rate Elements (Cont'd)

Video Digital Transport Service offers two methods to reach the Video Digital Transport Service resources that provide transport and some cases management and control of a video call. One, the Video Digital Transport Service Access Line (VCAL) includes video-enabling equipment along with circuit and outside plant facilities to access the customer's serving wire center. The other, the Video Digital Transport Service Access Port does not include the video-enabling equipment as part of the network service.

Each Video Digital Transport Service interconnection between customer locations requires that at least one of the locations be served by a VCAL, to provide video transmission and/or reception and to allow the Company to monitor and meet the technical parameters of the service.

Video Digital Transport Service Utilization as provided for in this section of the tariff includes transport and termination of the interoffice transmission of the customer's Video Digital Transport Service signals and may include, low and high level video switching elements, and video network customer control elements. Low and High level video switching elements refer to the use of Video Multipoint Control Units (MCU), Digital Cross Connect Units (DCC) or Asynchronous Transfer Mode (ATM) switching facilities. These switching facilities are included in the basic video network as required to meet Video Digital Transport Service service requirements.

Video Digital Transport Service Premium Services are optional services that are not part of a basic video interconnection between customer locations. Video Digital Transport Service Premium Services currently include Quad Split and Image Plus Still Frame. Quad Split allows one customer location to view the video transmissions from up to three other locations of a multipoint connection on a single monitor over a single Video Digital Transport Service Access Line (VCAL). Image Plus Still Frame provides for the transmission of a still frame (such as a graphics overhead) and the motion video image over a single VCAL.

Applies to All Exchanges Illinois

FACILITIES FOR INTRASTATE ACCESS

13. VIDEO DIGITAL TRANSPORT SERVICE (Cont'd)

13.3 Description (Cont'd)

13.3.6 Ordering Service

When Video Digital Transport Service is ordered the customer selects a VCAL with consideration to the customer's specific video communications requirements. These requirements include, but are not limited to, the transmission parameters, the Video Digital Transport Service Premium Services that are available with that type of access line and whether or not the desired service is a fixed point-to-point service or a switched service.

Each form of Video Digital Transport Service is identified in this tariff as a type of Video Digital Transport Service. The identification of a type of service as Broadcast, Commercial or Business Quality is not intended to limit a customer's use of that type of VCAL and the associated interoffice transmission (utilization). The type nomenclature is intended to only to provide general guidance as to the quality of video transmission and its typical use. So long as the components of Video Digital Transport Service are utilized in the transmission, a customer can transmit any signals that his customer premises equipment (CPE) will support. For example, if the customer's CPE is capable of transmitting voice over a subscribed Video Digital Transport Service there is no restriction against doing so provided that the components of the Video Digital Transport Service are used in the transmission. The Company does not warrant such alternative use of the service nor guarantee that changes will not be made in the service that may negate these uses.

13.3.7 Video Digital Transport Service Access Line

The Video Digital Transport Service Access Line rate applies for each customer designated location at which a VCAL is terminated. The charge will apply even if the CDL and the serving wire center are co-located in a Company building. The applicable VCAL rate is determined by the type of Video Digital Transport Service that the customer orders and receives at his CDL. This VCAL rate provides for the Video Digital Transport Service connection between the network demarcation point at the customer's premises and the Telephone Company's serving wire center. The Video Digital Transport Service connection includes the appropriate video access line interface arrangement, circuit equipment and outside plant facilities.

Issued: May 10, 2011

Effective: July 1, 2011

By Kenneth Mason
Vice President
of Government and Regulatory Affairs

Applies to All Exchanges Illinois

FACILITIES FOR INTRASTATE ACCESS

13. VIDEO DIGITAL TRANSPORT SERVICE (Cont'd)

13.3 Description (Cont'd)

13.3.7 Video Digital Transport Service Access Line (Cont'd)

The standard video access line interface arrangement defines the technical characteristics associated with the type of facilities with which the video service will interconnect at its Point of Termination (POT) and the type of signaling capability, if any. The VCAL includes any video encoding device that maybe required to provide the service.

13.3.8 Video Digital Transport Service Access Port

The Video Digital Transport Service Access Port rate applies for each Video Digital Transport Service Access Port provided by the Company for the use of the customer. The Video Digital Transport Service Access Port provides the customer with a point of entry to the Company's switched video network in those instances where a Video Digital Transport Service Access Line cannot be provided. For example a customer whose CDL is located outside the MSA or outside the Frontier serving area within the MSA may use a Video Digital Transport Service Service Access Port as a point of entry to the Company's switched video network. This would allow that customer to make video connections to other customers who have Video Digital Transport Service through the Company's switched video network in that MSA. The customer must obtain the appropriate transport from his CDL to the Company's Video Digital Transport Service Access Port and must present signals that are compatible with interface requirements of the VCALs to which he wants to connect.

The Video Digital Transport Service Access Port includes a standard video access interface arrangement defining the technical characteristics associated with the type of facilities to which the video service is connected to and the type of signaling capability, if any. The Video Digital Transport Service Access Port does not include any video encoding devices but may include devices to control and monitor the video service.

Issued: May 10, 2011

Effective: July 1, 2011

By Kenneth Mason
Vice President
of Government and Regulatory Affairs

Applies to All Exchanges Illinois

FACILITIES FOR INTRASTATE ACCESS

13. VIDEO DIGITAL TRANSPORT SERVICE (Cont'd)

13.3 Description (Cont'd)

13.3.9 Video Digital Transport Service Service Utilization

The Video Digital Transport Service Utilization rate applies per access line for usage of the Company's intraMSA interoffice network. The type of Video Digital Transport Service Access Line determines the applicable Video Digital Transport Service Utilization rate. This rate is an all inclusive utilization rate for an access line providing switched video service. In the case of an access line providing point-to-point service this rate is comprised of termination and transport rates. The termination and transport rates applicable for point-to-point type video services that are not found in this section of the tariff (as in the case of Business Quality Connect) must be ordered from the Section 5, Special Access. A customer using Business Quality Connect point-to-point services would order Video Digital Transport Service Access Lines from this section of the tariff and appropriate Special Access Service for interoffice network transport and termination of his video signals.

13.3.10 Video Digital Transport Service Premium Services

The Video Digital Transport Service Premium Services Quad Split and Image Plus Still Frame are optional services that are not part of a basic video interconnection between customer locations. The rate for these optional services applies to each access line for which they are ordered. Quad Split allows one customer location to view the video transmissions from up to three other locations of a multipoint connection on a single monitor over a single Video Digital Transport Service Access Line. Image Plus Still Frame provides for the transmission of a still frame (such as a graphics overhead) and the motion video image over a single Video Digital Transport Service Access Line.

13.3.11 Special Construction

Special Construction charges as provided for in Section 10 will apply in those instances where the customer orders video service where suitable facilities are not available. If the customer orders video services not provided for in this tariff, Special Assembly rates and charges will apply. Special construction charges consisting of labor and material charges may apply for upgrades to fiber facilities.

Applies to All Exchanges Illinois

FACILITIES FOR INTRASTATE ACCESS

13. VIDEO DIGITAL TRANSPORT SERVICE (Cont'd)

13.4 Regulations

13.4.1 Responsibilities of the Company

- (A) The Company's responsibility will be limited to the furnishing of Video Digital Transport Service facilities suitable for the Video Digital Transport Service connection. The Company is not responsible for the installation, operation or maintenance of any equipment provided by the customer.
- (B) The Company reserves the right to temporarily interrupt Video Digital Transport Service to maintain the video equipment. Maintenance will be performed during hours that will minimize the impact of disruptions to customers. In addition, negotiated unscheduled or emergency situations may necessitate additional interruption time.

13.4.2 Limitations/Availability

- (A) Video Digital Transport Service will only be offered where Company facilities/equipment permit. Special Construction Charges may apply.
- (B) Video Digital Transport Service as provided for in this tariff is available only between Frontier customer locations within the same MSA except as noted below. The customer may obtain appropriate services from an Interexchange Carrier to interconnect his Video Digital Transport Service locations to other video service locations outside the MSA. Similarly a customer utilizing Type II Broadcast Quality Connect Service or Type II Commercial Quality Video Digital Transport Service can obtain access to a location outside the Frontier serving area or outside the MSA by obtaining appropriate service from that location to a Video Digital Transport Service Access Port on the Company's switched video network.
- (C) A Video Digital Transport Service Access Port can only be used to interconnect to a customer location that is not located in the Company's serving area within the MSA or is outside the MSA.
- (D) The Video Digital Transport Service Utilization Transport (interoffice) for Broadcast Quality Connect Type I and Commercial Quality Connect Type I is limited to a maximum of 25 airline miles.

Applies to All Exchanges Illinois

FACILITIES FOR INTRASTATE ACCESS

13. VIDEO DIGITAL TRANSPORT SERVICE (Cont'd)

13.4 Regulations

13.4.2 Limitations/Availability (Cont'd)

(E) The minimum service period is one year except as specified else where within this tariff.

13.4.3 Application of Rates

(A) The following rate elements apply to Video Digital Transport Service:

(1) Video Digital Transport Service Access Line

(a) Broadcast Quality Connect

Type I

Transmit

Receive

Type II Transceive

(b) Commercial Quality Connect

Type I

Transmit

Additional Transmit

Receive

Additional Receive

Type II Transceive

(c) Business Quality Connect

Type II Transceive

Applies to All Exchanges Illinois

FACILITIES FOR INTRASTATE ACCESS

13. VIDEO DIGITAL TRANSPORT SERVICE (Cont'd)

13.4 Regulations (Cont'd)

13.4.3 Application of Rates

- (2) Video Digital Transport Service Access Port
 - (a) Broadcast Quality Connect
Type II
 - (b) Commercial Quality Connect
Type II

- (3) Video Digital Transport Service Utilization
 - (a) Broadcast Quality Connect
 - Type I
 - Transport (per mile)
 - Type II
 - (b) Commercial Quality Connect
 - Type I
 - Transport (per mile)
 - Type II
 - (c) Business Quality Connect
 - Type II
 - Transport - (DS1 Transport)
 - Termination - (DS1 Termination)

- (4) Video Digital Transport Service Premium Services
 - (a) Quad Split
 - (b) Image Plus Still Frame

Applies to All Exchanges Illinois

FACILITIES FOR INTRASTATE ACCESS

13. VIDEO DIGITAL TRANSPORT SERVICE (Cont'd)

13.4 Regulations (Cont'd)

13.4.3 Application of Rates (Cont'd)

(B) Video Digital Transport Service Access Line

(1) Broadcast Quality Connect Type I

The Type I Broadcast Quality Connect Video Digital Transport Service Access Line is a one way facility. The customer must order a Transmit access line to transmit video signals over the Company's network facilities. Similarly the customer must order a Receive access line to receive video signals over the Company's facilities. If the customer requires both transmit and receive capability at the same premises then the customer must order both a Transmit and a Receive access line.

(2) Broadcast Quality Connect Type II

The Type II Broadcast Quality Connect Video Digital Transport Service Access Line is a bidirectional facility. The customer ordering this type of access line will be provided with a facility capable of providing simultaneous transmission and reception of video signals to and from the switched point of termination (SPOT). The SPOT will be either another Type II Broadcast Quality Video Digital Transport Service Access Line or a Video Digital Transport Service Access Port within the same MSA.

(3) Commercial Quality Connect Type I

The Type I Commercial Quality Connect Video Digital Transport Service Access Line is a unidirectional facility. The customer must order a Transmit access line to transmit video signals over the Company's network facilities. Similarly the customer must order a Receive access line to receive video signals over the Company's facilities. If the customer requires both transmit and receive capability at the same premises then the customer must order both a Transmit and a Receive access line.

Applies to All Exchanges Illinois

FACILITIES FOR INTRASTATE ACCESS

13. VIDEO DIGITAL TRANSPORT SERVICE (Cont'd)

13.4 Regulations (Cont'd)

13.4.3 Application of Rates (Cont'd)

(B) Video Digital Transport Service Access Line (Cont'd)

(3) Commercial Quality Connect Type I (Cont'd)

The first Transmit or the first Receive access line that the customer orders for a customer designated location will be provided at the "First System" rate. Subsequent Transmit or Receive access lines that the customer orders for the same CDL will be provided at the "Additional System" rate unless the total access lines (systems) exceeds sixteen. If the total number of access lines exceeds sixteen then the seventeenth and every subsequent seventeenth access line will be rated as a "First System" with the others rated as "Additional Systems."

(4) Commercial Quality Connect Type II

The Type II Commercial Quality Connect Video Digital Transport Service Access Line is a bidirectional facility. The customer ordering this type of access line will be provided with a facility capable of providing simultaneous transmission and reception of video signals to and from the switched point of termination. The SPOT will be either another Type II Commercial Quality Connect Video Digital Transport Service Access Line or a Video Digital Transport Service Access Port within the same MSA.

(5) Business Quality Connect Type II

The Type II Business Quality Connect Video Digital Transport Service Access Line is a bidirectional facility. The customer ordering this type of access line will be provided with a facility capable of providing simultaneous transmission and reception of video signals to and from another such access line or similar facility over DS1 facilities.

Applies to All Exchanges Illinois

FACILITIES FOR INTRASTATE ACCESS

13. VIDEO DIGITAL TRANSPORT SERVICE (Cont'd)

13.4 Regulations (Cont'd)

13.4.3 Application of Rates (Cont'd)

(C) Video Digital Transport Service Access Port

(1) Broadcast Quality Connect Type II

The Type II Broadcast Quality Connect Video Digital Transport Service Access Port is a bidirectional facility. A customer may only order this type of access to the Company's switched video transport facilities to terminate transport of compatible video signals from outside the Company's serving area within the MSA or from outside the MSA. This facility may not be ordered in lieu of a Video Digital Transport Service Access Line (VCAL) under circumstances where the Company has tariff authority to provide a VCAL.

(2) Commercial Quality Connect Type II

The Type II Commercial Quality Video Digital Transport Service Access Port is a bidirectional facility. A customer may only order this type of access to the Company's switched video transport facilities to terminate transport of compatible video signals from outside the Company's serving area within the MSA or from outside the MSA. This facility may not be ordered in lieu of a Video Digital Transport Service Access Line (VCAL) under circumstances where the Company has tariff authority to provide a VCAL.

Applies to All Exchanges Illinois

FACILITIES FOR INTRASTATE ACCESS

13. VIDEO DIGITAL TRANSPORT SERVICE (Cont'd)

13.4 Regulations (Cont'd)

13.4.3 Application of Rates (Cont'd)

(D) Video Digital Transport Service Utilization

Video Digital Transport Service Utilization may only be ordered in conjunction with a Video Digital Transport Service Access Port.

(1) Broadcast Quality Connect Type I

Type I Broadcast Quality Connect Utilization provides for the interoffice transport and termination of signals originating from and/or terminating to Type I Broadcast Quality Connect VCALs. The monthly charges (MRCs) for the Transport rate element are assessed on a per airline mile basis. Fractional parts of miles are rounded to the next higher mile before making the rate computation. The transport distance is limited to a maximum of 25 airline miles.

(2) Broadcast Quality Connect Type II

Type II Broadcast Quality Connect Utilization provides for the switching, interoffice transport and termination of signals originating from and terminating to Type II Broadcast Quality Connect VCALs or Access Ports. The Video Digital Transport Service Utilization NRC and MRC is assessed for each VCAL and each Access Port.

(3) Commercial Quality Connect Type I

Type I Commercial Quality Connect Utilization provides for the interoffice transport and termination of signals originating from and/or terminating to Type I Commercial Quality Connect VCALs. The MRC portion of the Transport rate element is assessed on a per airline mile basis. Fractional parts of miles are rounded to the next higher mile before making the rate computation. The transport distance is limited to a maximum of 25 airline miles.

Applies to All Exchanges Illinois

FACILITIES FOR INTRASTATE ACCESS

13. VIDEO DIGITAL TRANSPORT SERVICE (Cont'd)

13.4 Regulations (Cont'd)

13.4.3 Application of Rates (Cont'd)

(D) Video Digital Transport Service Utilization (Cont'd)

(4) Commercial Quality Connect Type II

Type II Commercial Quality Connect Utilization provides for the switching, interoffice transport and termination of signals originating from and terminating to Type II Commercial Quality Connect Video Digital Transport Service Access Lines (VCALs) or Access Ports. The Video Digital Transport Service Utilization NRC and MRC is assessed for each VCAL and each Access Port.

(5) Business Quality Connect Type II

Type II Business Quality Connect Utilization provides for the interoffice transport and termination of signals originating from or terminating to Type II Commercial Quality Connect VCALs. Business Quality Connect Utilization is provided by DS1 Service as shown in Section 5.

(E) Video Digital Transport Service Premium Services

(1) Quad Split

Quad Split is an optional enhancement to standard Type II Commercial Quality Connect Service. The Quad Split rate is applied on a per VCAL or per Access Port basis. This rate applies in addition to the regular VCAL or Access Port rate.

(2) Image Plus Still Frame

Image Plus Still Frame is an optional enhancement to standard Business Quality Connect Type II Services. The Image Plus Still Frame rate is applied on a per Video Digital Transport Service Access Line (VCAL) basis. This rate applies in addition to the regular VCAL rate.

Applies to All Exchanges Illinois

FACILITIES FOR INTRASTATE ACCESS

13. VIDEO DIGITAL TRANSPORT SERVICE (Cont'd)

13.5 General Rate Regulations

13.5.1 Moves

When a customer requests a move or relocation of a VCAL or Access Port, this move or relocation will be treated as a termination of the existing service and the establishment of a new service for the application of all charges.

13.5.2 Cancellation or Change for Application for Service

When an application for service is canceled or changed in whole or in part:

- After the completion of installation, but prior to the establishment of service

The customer is required to pay all nonrecurring and minimum charges which would apply had service been established.

- Prior to the completion of installation

The customer may be required to pay the costs incurred by the Company but not exceeding the amount that would be charged above.

13.5.3 Custom Payment Plans

At the request of a customer the Company may at its option offer a Custom Payment Plan that provides a payment schedule that has a net present value equal to the net present value of the nonrecurring charges and monthly charges that would otherwise be payable under the contract period selected. The net present value computations shall be made utilizing the Company's Authorized Rate of Return. The NRCs associated with a Custom Payment Plan will not be less than twenty five percent (25%) of the nonrecurring charges shown in 13.6. Such Custom Payment Plan methodology may be used to provide a Custom Payment Plan with an NRC and a zero MRC. In any instance, the Custom Payment Plan provides only for service during the specified contract period and does not give the customer ownership of or equity in the facilities that the Company provides in the provision of the service(s).

Applies to All Exchanges Illinois

FACILITIES FOR INTRASTATE ACCESS

13. VIDEO DIGITAL TRANSPORT SERVICE (Cont'd)

13.5 General Rate Regulations (Cont'd)

13.5.4 Expiration of Contract Period

If the customer's contract period expires and the customer has not canceled his service or established a new contract with the Company, the customer's service shall be continued under a month-to-month contract at the monthly rate(s) specified in this tariff for the contract term that has just expired. This procedure will continue the customer's service with no change in monthly rates except in those instances when the expired contract was under a Custom Payment Plan.

When one contract period ends and a new one begins the customer, begins paying the MRC for the new contract period. The NRC is not accessed again unless the customer has required the Company to change the service in some way or unless service has been discontinued between the expiration of the old contract and the initiation of the new contract.

Applies to All Exchanges Illinois

FACILITIES FOR INTRASTATE ACCESS

13. VIDEO DIGITAL TRANSPORT SERVICE (Cont'd)

13.6 Rates And Charges

The following rates and charges apply for Video Digital Transport Service

	Nonrecurring Charge	Monthly Rate			
		One Year	Three Year	Five Year	Seven Year

13.6.1 Video Digital Transport Service Access Line

(A) Broadcast Quality Connect

Type I					
Transmit	\$1,500.00	\$ 640.00	\$ 580.00	\$ 515.00	\$ 465.00
Receive.....	1,500.00	640.00	580.00	515.00	465.00
Type II					
Transceive	\$9,500.00	2,880.00	2,580.00	2,225.00	2,000.00

(B) Commercial Quality Connect

Type I					
Transmit-First System	650.00	640.00	580.00	515.00	465.00
Transmit-Add'l System	280.00	285.00	260.00	230.00	205.00
Receive-First System	650.00	640.00	580.00	515.00	465.00
Receive-Add'l System(s)	80.00	285.00	260.00	230.00	205.00
Type II					
Transceive	2,200.00	1,385.00	1,250.00	1,110.00	995.00

Issued: May 10, 2011

Effective: July 1, 2011

By Kenneth Mason
 Vice President
 of Government and Regulatory Affairs

Applies to All Exchanges Illinois

FACILITIES FOR INTRASTATE ACCESS

13. VIDEO DIGITAL TRANSPORT SERVICE (Cont'd)

13.6 Rates And Charges

The following rates and charges apply for Video Digital Transport Service

		<u>Monthly Rate</u>			
	<u>Nonrecurring</u>	<u>One</u>	<u>Three</u>	<u>Five</u>	<u>Seven</u>
	<u>Charge</u>	<u>Year</u>	<u>Year</u>	<u>Year</u>	<u>Year</u>
13.6.2 <u>Video Digital Transport Service Access Port</u>					

(A) Broadcast Quality Connect

Type II	100.00	100.00	100.00	100.00	100.00
.....					

(B) Commercial Quality Connect

Type II	100.00	100.00	100.00	100.00	100.00
.....					

Issued: May 10, 2011

Effective: July 1, 2011

By Kenneth Mason
 Vice President
 of Government and Regulatory Affairs

Applies to All Exchanges Illinois

FACILITIES FOR INTRASTATE ACCESS

13. VIDEO DIGITAL TRANSPORT SERVICE (Cont'd)

13.6 Rates And Charges (Cont'd)

The following rates and charges apply for Video Digital Transport Service

Nonrecurring <u>Charge</u>	<u>Monthly Rate</u>			
	<u>One Year</u>	<u>Three Year</u>	<u>Five Year</u>	<u>Seven Year</u>

13.6.3 Video Digital Transport Service Utilization

(A) Broadcast Quality Connect

Type I.....	\$ 150.00				
Transport (per mile)		\$ 37.50	\$ 37.50	\$ 37.50	\$ 37.50
Type II	None	950.00	950.00	950.00	950.00

(B) Commercial Quality Connect

Type I.....	150.00				
Transport (per mile)		37.50	37.50	37.50	37.50
Type II	None	950.00	950.00	950.00	950.00

(C) Business Quality Connect

Type II	See Section 5, DS1 Rates and Charges
---------------	--------------------------------------

13.6.4 Video Digital Transport Service Premium Services

(A) <u>Quad Split</u>	None	\$1,450.00	\$1,450.00	\$1,450.00	\$1,450.00
-----------------------------	------	------------	------------	------------	------------

(B) Image Plus Still Frame

Business Quality Type II	150.00	300.00	300.00	300.00	300.00
--------------------------	--------	--------	--------	--------	--------

Applies to All Exchanges Illinois

FACILITIES FOR INTRASTATE ACCESS

14. EXCEPTIONS TO FIA OFFERINGS

14.1 General

The FIA/Services offered under the provisions of this tariff are subject to availability as set forth in 2.1.4 preceding.

14.2 The following items are offered only to existing ICs and/or end users at their existing points of presence and/or premises, respectively, associated with existing FIA arrangements:

(Reserved for future use)

14.3 The following items are offered only to existing ICs and/or end users at their existing points of presence and/or premises, respectively, associated with existing FIA arrangements and to fill out existing capacity:

(Reserved for future use)

Applies to All Exchanges Illinois

FACILITIES FOR INTRASTATE ACCESS

SECTION 15 TABLE OF CONTENTS

15. <u>Reserved for Future Use</u>	<u>Page</u>	(T)
		(D)
		(D)

Applies to All Exchanges Illinois

FACILITIES FOR INTRASTATE ACCESS

SECTION 15 TABLE OF CONTENTS

15. Reserved for Future Use (Cont'd) Page (T)

(D)

(D)

Applies to All Exchanges Illinois

FACILITIES FOR INTRASTATE ACCESS

SECTION 15 TABLE OF CONTENTS

15. Reserved for Future Use (Cont'd) Page (T)

(D)

(D)

Applies to All Exchanges Illinois

FACILITIES FOR INTRASTATE ACCESS

SECTION 15 TABLE OF CONTENTS

15. Reserved for Future Use (Cont'd) Page (T)

(D)

(D)

Applies to All Exchanges Illinois

FACILITIES FOR INTRASTATE ACCESS

SECTION 15 TABLE OF CONTENTS

15. Reserved for Future Use (Cont'd) Page (T)

(D)

(D)

Applies to All Exchanges Illinois

FACILITIES FOR INTRASTATE ACCESS

SECTION 15 TABLE OF CONTENTS

15. <u>Reserved for Future Use</u> (Cont'd)	<u>Page</u>	(T)
		(D)
		(D)

Applies to All Exchanges Illinois

FACILITIES FOR INTRASTATE ACCESS

SECTION 16 TABLE OF CONTENTS

16.	<u>ADVANCED COMMUNICATIONS NETWORKS</u>	<u>Page</u>	
16.1	(A) <u>General</u>	2	
	(B) <u>Generic Name</u>	2	
	(C) <u>Administrative Changes</u>	2	
	(D) <u>Moves</u>	3	
16.2	<u>Packet Switching Network Service</u> *	5	
	(A) <u>Service Description</u>	5	
	(B) <u>Service Provisioning</u>	5	
	(C) <u>Rate Regulations</u>	7	
	(1) Minimum Period	7	
	(2) Rate Application	7	
	(D) <u>Supplemental Features</u>	8	
	(1) Fast Select	8	
	(2) Priority	8	
	(E) <u>Rates and Charges</u>	8	
	(1) X.75 Access	8	
	(2) Logical Channels	8	
	(3) Supplemental Features	9	
16.3	<u>Frame Relay Service – Grandfathered</u> *, ¹	10	(C)
	(A) <u>Service Description</u>	10	
	(B) <u>Service Provisioning</u>	11	
	(C) <u>Obligations of the Company</u>	12	
	(D) <u>Obligations of the Customer</u>	13	
	(E) <u>Rate Regulations</u>	14	
	(1) Minimum Period	14	
	(2) Rate Elements	14	
	(3) Rate Application	16	
	(4) Term Payment Plan (TPP)	17	
	(F) <u>Rates</u>	23	
	(1) Frame Relay UNI Port and Access Line, each	23	
	(2) Frame Relay UNI Port Only, each	23	
	(3) Frame Relay NNI Port Only, each	25	
	(4) Frame Relay Permanent Virtual Circuit (PVC) each	25	
	(5) Interzone CIR and Priority PVCs Based on CIR Requested	26	

* Grandfathered Offering.

¹ Effective May 31, 2022, Frontier will no longer support Moves, Adds or Changes nor new installations for [Frame Relay] Service. Upon service term expiration, this service will transition to a Month-to-Month service arrangement. (N)
|
(N)

Applies to All Exchanges Illinois

FACILITIES FOR INTRASTATE ACCESS

16. ADVANCED COMMUNICATIONS NETWORKS

16.1(A) General

This section contains the rules and regulations pertaining to the provision of Packet Switching Network Service* and Frame Relay Service*,¹. The regulations and rates specified herein are in addition to the applicable regulations and rates specified in other sections of this tariff.

(C)

The following is a list of Open Network Architecture (ONA) Packet Service Basic Service Elements (BSEs) which provide a cross-reference to the generic ONA product names.

(B) Generic Name Frontier

Fast Select Acceptance – Packet.....Fast Select

Fast Select Request – PacketFast Select

(C) Administrative Changes

Administrative changes to existing service will be made without charge(s) to the customer. Administrative changes are as follows:

- Change of customer name, i.e., the customer of record does not change but rather the name of record changes its name, e.g., XYZ Company to XYZ Communications,
- Change of customer premises address when the change of address is not a result of a physical relocation of facilities,
- Change in billing data (name, address or contact name or telephone number),
- Change of customer contact name or telephone number, and
- Change of customer service element identification,
- Change of jurisdiction involving no physical changes to the service.

* Grandfathered Offering.

¹ Effective May 31, 2022, Frontier will no longer support Moves, Adds or Changes nor new installations for [Frame Relay] Service. Upon service term expiration, this service will transition to a Month-to-Month service arrangement.

(N)
|
(N)

Applies to All Exchanges Illinois

FACILITIES FOR INTRASTATE ACCESS

16. ADVANCED COMMUNICATIONS NETWORKS

16.1(D) Moves

A move involves a change in the physical location of the point of termination of service. A move normally involves an interruption of service for the period required to complete the move. No credit allowance will be granted for that period. Special construction as set forth in Section 10 may also be applicable at the different CDL.

A customer may request that service not be interrupted during a move. To comply with that request it may be necessary to install a duplicate service, and subsequently discontinue the existing service. Charges, monthly and nonrecurring, will apply for the duplicate service. A new minimum period will be established for the duplicate portion of the service, depending on which end of the service is moved. The customer will remain responsible for all minimum period charges associated with the corresponding portion of the disconnected service.

The charge for the move depends on whether the move is within the same CDL or to a different CDL.

(1) Same CDL

When the move of a termination of FIA, as defined in Section 2.1.5 is to a new point within the same CDL (same address and/or same building), the charge for the move will be the installation charge for the portion of the service being reterminated. There will be no change in the minimum period requirements. For services subject to payment plan regulations, the same payment period will remain in force.

Issued: May 10, 2011

Effective: July 1, 2011

By Kenneth Mason
Vice President
of Government and Regulatory Affairs

Applies to All Exchanges Illinois

FACILITIES FOR INTRASTATE ACCESS

16. ADVANCED COMMUNICATIONS NETWORKS

16.1(D) Moves (Cont'd)

(2) Different CDL

- (a) When the move is to a different CDL (different address and different building), except as specified below, it will be treated as a disconnect and an installation of service. The appropriate service installation charge for the service terminations(s) affected will apply. A new minimum period will be established for the installed service. The customer will remain responsible for all minimum period charges associated with the disconnected service. For services subject to full payment plan regulations, a new payment plan will be established and full assessment of the remaining liabilities will be applicable.
- (b) When the move is to a different CDL but served by the same serving wire center, the following conditions apply:
- A change ASR will be required.
 - The appropriate service installation charge for the service termination(s) will apply.
 - For services subject to payment plan regulations, if the customer of record remains the same with no lapse in service, the appropriate NRCs for changes will apply. Otherwise, the move will be treated as a disconnect and an installation of service and all appropriate NRCs and full assessment of the remaining liabilities will be applicable.

Issued: May 10, 2011

Effective: July 1, 2011

By Kenneth Mason
Vice President
of Government and Regulatory Affairs

Applies to All Exchanges Illinois

FACILITIES FOR INTRASTATE ACCESS

16. ADVANCED COMMUNICATIONS NETWORKS

16.2 Packet Switching Network Service

(A) Service Description

Packet Switching Network Service uses packet switching technology to provide a switched data transport service. This service uses analog and digital facilities to provide usage-sensitive data transport for a variety of interactive (or bursty) data applications between two or more customer designated locations (CDLs). The packet switch will be classified as a CDL.

Packet switching technology divides data streams into packets. The packet network examines, routes and transports packets individually without maintaining a physical path between bursts of data. This service is based on CCITT (Consultative Committee on International Telegraphy and Telephony) X.25 protocol and X.75 internetworking protocol. The X.25 and X.75 protocols are international standards developed by the CCITT that provide the foundation for Public Packet Switched Networks. Packet Switching Network Service and features are available where facilities and conditions permit.

(B) Service Provisioning

Customers may access the Packet Switching Network through an X.75 internetworking access.

Packet switching carriers with a Data Network Identification Code may interconnect to an access port on the Packet Switching Network with X.75 protocol at transmission speeds of 9.6 Kbps or 56 Kbps. Each X.75 access will require an X.75 Access Port charge, a DDS Special Access Line charge (9.6 Kbps or 56 Kbps), associated DDS Special Transport charges set forth in Section 5.

Applies to All Exchanges Illinois

FACILITIES FOR INTRASTATE ACCESS

16. ADVANCED COMMUNICATIONS NETWORKS (Cont'd)

16.2 Packet Switching Network Service (Cont'd)

(B) Service Provisioning (Cont'd)

The Special Access Line and Special Transport charges provide analog or digital connections from the packet carrier's location to the access port on the Telephone Company's packet network. Shared use (ratcheting) to provision the access connection is not permitted.

The special access service associated with packet switching will be subject to the meet point billing requirements set forth in Section 2. However, all usage recorded at the Telephone Company's packet switch will be billed by the Telephone Company.

Applies to All Exchanges Illinois

FACILITIES FOR INTRASTATE ACCESS

16. ADVANCED COMMUNICATIONS NETWORKS (Cont'd)

16.2 Packet Switching Network Service* (Cont'd)

(C) Rate Regulations

(1) Minimum Period

The minimum service period is one month.

(2) Rate Application

- (a) The monthly rates are flat-rates and are applied based on the speed and number of logical channels subscribed to per access port.
- (b) Monthly Rates for logical channels subscribed to will apply in addition to the monthly recurring charges for X.75 access. Rates applicable for X.75 access include a monthly recurring rate and an installation charge per X.75 access port, and are specified under Section 16.2(E)(1). A DDS Special Access Line charge (9.6 Kbps or 56 Kbps), associated DDS Special Transport from Section 5 will also apply.

* Effective December 2, 2005, this service is no longer available to new customers and current customers may not make changes or additions to existing service.

Applies to All Exchanges Illinois

FACILITIES FOR INTRASTATE ACCESS

16. ADVANCED COMMUNICATIONS NETWORKS (Cont'd)

16.2 Packet Switching Network Service* (Cont'd)

(D) Supplemental Features

- (1) Fast Select allows a sending data terminal to forward up to 128 bytes of data along with call setup and clearing packets. This feature is available to all customers and is initiated on a call-by-call basis.
- (2) Priority allows a customer to establish a "priority" status to the customer's data as it processes through the network. This feature is available to all customers and is initiated on a call-by-call basis.

(E) Rates and Charges

	<u>Nonrecurring Charge</u>	<u>Monthly Rate</u>
(1) <u>X.75 Access, Per Port</u>		
- 9.6 Kbps	\$100.00	\$75.00
- 56 Kbps	100.00	130.00
(2) <u>Logical Channels</u>		
<u>9.2 Kbps Port</u>		
12 Logical Channels, Per Month	--	48.00
22 Logical Channels, Per Month	--	88.00
32 Logical Channels, Per Month	--	128.00
<u>56 Kbps Port</u>		
32 Logical Channels, Per Month	--	128.00
60 Logical Channels, Per Month	--	240.00
90 Logical Channels, Per Month	--	360.00

* Effective December 2, 2005, this service is no longer available to new customers and current customers may not make changes or additions to existing service.

Issued: May 10, 2011

Effective: July 1, 2011

By Kenneth Mason
 Vice President
 of Government and Regulatory Affairs

Applies to All Exchanges Illinois

FACILITIES FOR INTRASTATE ACCESS

16. ADVANCED COMMUNICATIONS NETWORKS (Cont'd)

16.2 Packet Switching Network Service* (Cont'd)

(E) Rates and Charges (Cont'd)

	<u>Nonrecurring Charge</u>	<u>Monthly Rate</u>
(3) <u>Supplemental Features</u>		
Fast Select, Per Virtual Connection	.001	
Priority, Per Kilosegment*35

* Effective December 2, 2005, this service is no longer available to new customers and current customers may not make changes or additions to existing service.

Applies to All Exchanges Illinois

FACILITIES FOR INTRASTATE ACCESS

16. ADVANCED COMMUNICATIONS NETWORKS (Cont'd)

16.3 Frame Relay Service – Grandfathered ¹

(C)

Effective July 20, 2003, Frame Relay Service is no longer available to new customers. Existing TPP/OPP customers may continue their service until their TPP/OPP expires or their service is disconnected, whichever occurs first. Existing month-to-month customers may continue their service until July 20, 2008 or until their service is disconnected, whichever occurs first. Moves, additions, or changes will not be permitted.

(A) Service Description

Frame Relay Service (FRS) is a “fast packet” network service that permits the transmission of data at speeds of 56 Kbps, 384 Kbps or 1.544 Mbps using Permanent Virtual Circuits (PVCs).

PVCs are logical circuits that define a specific path for data sent by the customer to another location. These circuits are virtual because they are established in software tables and do not tie up capacity when not in use. This also allows multiple PVCs to be defined over a single access line, thereby providing a single access line the capability to transmit data to multiple destinations.

In operation of Frame Relay Service, customer premises equipment, such as routers, encapsulate arriving data into variable length frames. These frames contain information identifying which PVC in the network should be used to forward the frame to the proper destination. The customer premises equipment then sends the frame into the Frame Relay network. The Frame Relay switch reads identifying information and routes the frame to the proper destination based on a pre-established PVC.

The statistical multiplexing Frame Relay switches are able to provide shared network resources to end users of this service.

Frame Relay Service conforms to Consultative Committee for International Telegraph and Telephone (CCITT) and American National Standards Institute (ANSI) publications T1.602, T1.606, T1.617 and T1.618.

¹ Effective May 31, 2022, Frontier will no longer support Moves, Adds or Changes nor new installations for [Frame Relay] Service. Upon service term expiration, this service will transition to a Month-to-Month service arrangement.

(D)
(N)
|
(N)

Applies to All Exchanges Illinois

FACILITIES FOR INTRASTATE ACCESS

16. ADVANCED COMMUNICATIONS NETWORKS (Cont'd)16.3 Frame Relay Service – Grandfathered ¹ (Cont'd)

(C)

(B) Service Provisioning

Frame Relay is a transport service that facilitates the exchange of variable length information units (frames) between end user connections by way of assigned virtual connections. Each frame is passed to the Frame Relay network with an address that specifies the virtual connection.

Variable frame length capability is useful in communications between asynchronous Local Area Networks (LANs) and for transport of synchronous data traffic. Frame Relay is capable of handling the requirements of bursty data sources because of the ability of the service to allocate additional bandwidth when not in use by other sources.

Frame Relay is provided to the customer in the form of the Frame Relay User-to-Network Interface (UNI) Port with Access Line, or Frame Relay UNI Port Only, Frame Relay Network-to-Network (NNI) Port Only, and Permanent Virtual Circuits. The Frame Relay Access Line forms the component which provides the customer access to the customer's serving wire center and interoffice transport from the customer's serving wire center to the Frame Relay Switch. The Frame Relay Access line is provided for use only with Frame Relay Service. The Frame Relay UNI and NNI Port Only are provided for digital special access line connections to the network supporting Frame Relay Service. Digital special access lines are available from Section 5.

PVCs are provisioned on either 56 Kbps, 384 Kbps or 1.544 Mbps ports, depending upon the customer's networking requirements. The actual throughput of aggregated PVC bandwidths in use at the same time on the same port cannot exceed the port speed. Since all PVCs need not be in use at the same time, it is possible for the total bandwidth of all PVCs associated with one Frame Relay Access Line to exceed the bandwidth of that Frame Relay Access Line. This relationship is referred to as over-subscription and when this occurs, there can be no guarantee that the bandwidth defined for that PVC will be available at any point in time. No PVC can have a greater bit rate than the bit rate of the associated access line. A PVC must be associated with at least one Frame Relay Port. A Frame Relay Port can be associated with multiple PVCs.

¹ Effective May 31, 2022, Frontier will no longer support Moves, Adds or Changes nor new installations for [Frame Relay] Service. Upon service term expiration, this service will transition to a Month-to-Month service arrangement.

(D)
(N)
|
(N)

Applies to All Exchanges Illinois

FACILITIES FOR INTRASTATE ACCESS

16. ADVANCED COMMUNICATIONS NETWORKS (Cont'd)

16.3 Frame Relay Service – Grandfathered ¹ (Cont'd) (C)

(B) Service Provisioning (Cont'd)

A customer subscribing to a FRS port or port with access line will be referred to as the Controller of the Frame Relay Port. A customer may request data transmission capability to another customer. Both customers must have a Frame Relay Access Line and Frame Relay Port. The Controller of each Frame Relay Access Line must have written permission from the Controller(s) of each of the Frame Relay Access Lines to which a PVC is requested.

The Frame Relay Port and PVC may be ordered and billed independently and can have different customers as Controllers.

The Company does not undertake to originate data, but offers the use of its service components, where available, to customers for the purpose of transporting customer-originated data.

Frame Relay Service is available where facilities and conditions permit.

(C) Obligations of the Company

In addition to the general conditions described in Section 2, when the customer orders a PVC which is relayed to other Local Exchange Carriers, Interexchange Carriers or other Frame Relay networks, the Company will provide assistance in establishing this PVC.

The Company has the service responsibility up to and including the network interface.

¹ Effective May 31, 2022, Frontier will no longer support Moves, Adds or Changes nor new installations for [Frame Relay] Service. Upon service term expiration, this service will transition to a Month-to-Month service arrangement. (D)
(N)
|
(N)

Applies to All Exchanges Illinois

FACILITIES FOR INTRASTATE ACCESS

16. ADVANCED COMMUNICATIONS NETWORKS (Cont'd)

16.3 Frame Relay Service – Grandfathered ¹ (Cont'd) (C)

(D) Obligations of the Customer

In addition to the general conditions described in Section 2:

- The customer's Frame Relay terminal equipment has the responsibility for retransmitting frames which are discarded due to errors or network congestion.
- The customer, upon request, shall furnish such information as may be required to permit the Company to design and maintain the Frame Relay Service it offers and to assure that the service arrangement is in compliance with the regulations contained herein.
- It shall be the responsibility of the customer to ensure the continuing compatibility of customer-provided equipment (CPE) that is used in conjunction with the Frame Relay Service. The CPE shall be in compliance with FCC rules and regulations.
- The customer shall be responsible for obtaining permission for the Company's agents or employees to enter the premises of the customer or its users at any reasonable hour for the purpose of installing, inspecting, repairing, or, upon termination of the service, removing the service components of the Company.

¹ Effective May 31, 2022, Frontier will no longer support Moves, Adds or Changes nor new installations for [Frame Relay] Service. Upon service term expiration, this service will transition to a Month-to-Month service arrangement.

(D)
(N)
|
(N)

Applies to All Exchanges Illinois

FACILITIES FOR INTRASTATE ACCESS

16. ADVANCED COMMUNICATIONS NETWORKS (Cont'd)16.3 Frame Relay Service – Grandfathered ¹ (Cont'd)

(C)

(E) Rate Regulations(1) Minimum Period

The minimum period for Frame Relay Service is one month, except when provided under a Term Payment Plan (TPP) arrangement. The regulations applicable to Frame Relay Service provided under a TPP arrangement is specified under 16.3(E)(4).

When PVCs are added to existing Frame Relay Service, the minimum period for the added PVCs is one month.

(2) Rate Elements

(a) Frame Relay UNI Port and Access Line

A nonrecurring charge and a monthly rate, based on the speed of the port connection (i.e., 56 Kbps, 384 Kbps, or 1.544 Mbps), apply per port for each physical connection to the network supporting Frame Relay Service. Each port includes one PVC, and can accommodate multiple PVCs. Clear channel capability, as necessary, is included at no additional charge.

(b) Frame Relay UNI or NNI Port only

A nonrecurring charge and a monthly rate, based on the speed of the port connection (i.e., 56 Kbps, 384 Kbps, or 1.544 Mbps), apply per port for each Frame Relay Access Line or digital private line connection to the network supporting Frame Relay Service. Each port includes one PVC, and can accommodate multiple PVCs.

(c) Frame Relay PVC

A nonrecurring charge and a monthly rate apply for each PVC.

¹ Effective May 31, 2022, Frontier will no longer support Moves, Adds or Changes nor new installations for [Frame Relay] Service. Upon service term expiration, this service will transition to a Month-to-Month service arrangement.

(D)
(N)
|
(N)

Applies to All Exchanges Illinois

FACILITIES FOR INTRASTATE ACCESS

16. ADVANCED COMMUNICATIONS NETWORKS (Cont'd)

16.3 Frame Relay Service – Grandfathered ¹ (Cont'd) (C)

(E) Rate Regulations (Cont'd)

(2) Rate Elements (Cont'd) (N)

(d) Frame Relay PVC – Interzone

A monthly rate applies for the PVC CIR capacity for each PVC requested by the customer. This rate allows the customer connectivity to any other the customer site within the state.

Customers may purchase Priority 1 or Priority 2 PVCs to prioritize PVCs at a higher rate and in lieu of CIR-PVCs. Priority PVCs will help ensure maximum performance and satisfaction for applications such as voice over Frame Relay.

(e) If the information provided by the customer on the requested PVCs results in an interstate arrangement, the PVC falls under federal jurisdiction and the CIR in Frontier Telephone Companies FCC Tariff No. 8 is applicable.

(D)

C Effective May 31, 2022, Frontier will no longer support Moves, Adds or Changes nor new installations for [Frame Relay] Service. Upon service term expiration, this service will transition to a Month-to-Month service arrangement. (N)
 |
 (N)

Applies to All Exchanges Illinois

FACILITIES FOR INTRASTATE ACCESS

16. ADVANCED COMMUNICATIONS NETWORKS (Cont'd)

16.3 Frame Relay Service – Grandfathered ¹ (Cont'd) (C)

(E) Rate Regulations (Cont'd)

(3) Rate Application

A customer may access Frame Relay Service via a Frame Relay Access Line or via Company provided digital access facilities offered under Section 5. If a customer utilizes a special access line to access FRS, the associated regulations, rates and charges for such facilities shall apply in addition to the rates and charges associated with the FRS rate elements.

A customer utilizing special access facilities to access FRS would incur the monthly rate and nonrecurring charge associated with the Frame Relay UNI or NNI Port Only. The UNI Port provides for a user to carrier connection; the NNI Port provides for a carrier-to-carrier connection.

When a customer orders additional PVCs or changes PVC assignments on a Frame Relay port after the initial port installation, the Frame Relay PVC nonrecurring charge shall apply per PVC added or changed.

The Frame Relay Access Line and PVC may be ordered and billed independently and can have different Controllers, as discussed under 16.3(B). A request by one customer to discontinue a PVC does not result in the disconnection of the Frame Relay Access Line and Port. Only the Controller of a Frame Relay Access Line may authorize a disconnect of that line.

(D)

¹ Effective May 31, 2022, Frontier will no longer support Moves, Adds or Changes nor new installations for [Frame Relay] Service. Upon service term expiration, this service will transition to a Month-to-Month service arrangement. (N)
|
(N)

Applies to All Exchanges Illinois

FACILITIES FOR INTRASTATE ACCESS

16. ADVANCED COMMUNICATIONS NETWORKS (Cont'd)

16.3 Frame Relay Service – Grandfathered ¹ (Cont'd) (C)

(E) Rate Regulations (Cont'd)

(4) Term Payment Plan (TPP)

(a) General

The terms and conditions specified herein are applicable to Frame Relay Service and are in addition to other regulations as specified in this tariff.

The Frame Relay UNI Port with Access Line, the Frame Relay UNI or NNI Port Only, and PVC rate elements are available under a TPP. Digital special access lines and additional features are available at their tariffed rates and regulations.

Frame Relay TPP rates will not be greater than standard month-to-month Frame Relay rates, for the same rate elements.

Three-year and five-year TPP rates will be equal to or less than the one-year TPP rates. Decreases to the one-year TPP rates will flow through to the three-year and five-year TPP rates.

Payment periods of one year, three year, and five-year are available to all customers at the applicable rates set forth in 16.3(F) regardless of when they subscribe to a TPP arrangement.

The customer must designate on the ASR the payment period for the TPP.

(D)

¹ Effective May 31, 2022, Frontier will no longer support Moves, Adds or Changes nor new installations for [Frame Relay] Service. Upon service term expiration, this service will transition to a Month-to-Month service arrangement. (N)
|
(N)

Applies to All Exchanges Illinois

FACILITIES FOR INTRASTATE ACCESS

16. ADVANCED COMMUNICATIONS NETWORKS (Cont'd)

16.3 Frame Relay Service – Grandfathered ¹ (Cont'd) (C)

(E) Rate Regulations (Cont'd)

(4) Term Payment Plan (TPP) (Cont'd)

(a) General (Cont'd)

Inside moves, provided in accordance with Section 5.6.4(A), will not incur termination liability charges.

Outside moves, provided in accordance with Section 5.6.4(B), will allow the customer to retain the same TPP payment period. Any other move will be treated as a disconnect of the service and termination liability charges will apply.

The threshold quantity is 300 DS0 equivalent ports, in service no later than 12 months from the date the TPP was initiated. These may include UNI and NNI ports. DS0 equivalents are measured as follows:

- 56 Kbps FRS is equivalent to one DS0 unit
- 384 Kbps FRS is equivalent to six DS0 units
- 1.544 Mbps FRS is equivalent to 24 DS0 units.

The threshold quantity is to be maintained for the length of the term selected.

Each customer's TPP will be reviewed annually. If the total quantity in service does not meet the threshold quantity, a payment equal to the difference between the discounted amount paid and the month-to-month amount that would have been charged for services not under a TPP arrangement will be assessed, plus a 10% penalty. The charges will be calculated using the in-service quantity at the time of review.

¹ Effective May 31, 2022, Frontier will no longer support Moves, Adds or Changes nor new installations for [Frame Relay] Service. Upon service term expiration, this service will transition to a Month-to-Month service arrangement.

(D)
(N)
|
(N)

Applies to All Exchanges Illinois

FACILITIES FOR INTRASTATE ACCESS

16. ADVANCED COMMUNICATIONS NETWORKS (Cont'd)16.3 Frame Relay Service – Grandfathered ¹ (Cont'd)

(C)

(E) Rate Regulations (Cont'd)(4) Term Payment Plan (TPP) (Cont'd)

(a) General (Cont'd)

The customer may choose to increase the DS0 equivalents within 30 days to the threshold quantity and continue under the TPP arrangement or choose to be billed on a going forward basis at the month-to-month rates.

If, after 30 days, the threshold level is not met, the TPP will automatically be changed to a standard month-to-month arrangement. Termination liability will apply.

(b) Changes in Length of TPP Period

Prior to the completion of the selected TPP period, the customer may elect to convert to a new TPP period of the same or different length, subject to the following conditions:

- No credit toward the new payment period will be given for payments made under the Original TPP arrangement.
- Nonrecurring charges will not be reapplied for existing service(s).
- If the new TPP period is shorter in length than the time remaining under the existing TPP, the change to the new TPP period constitutes a discontinuance of the existing TPP service and termination liability charges apply.

¹ Effective May 31, 2022, Frontier will no longer support Moves, Adds or Changes nor new installations for [Frame Relay] Service. Upon service term expiration, this service will transition to a Month-to-Month service arrangement.

(D)
(N)
|
(N)

Applies to All Exchanges Illinois

FACILITIES FOR INTRASTATE ACCESS

16. ADVANCED COMMUNICATIONS NETWORKS (Cont'd)

16.3 Frame Relay Service – Grandfathered ¹ (Cont'd) (C)

(E) Rate Regulations (Cont'd)

(4) Term Payment Plan (TPP) (Cont'd)

(c) Renewal Options

At the expiration of a TPP period, the Company will automatically renew the service at the same TPP period unless Customer chooses to convert to a different TPP period, convert to month-to-month rates or discontinue service.

Conversion to a different TPP period will require the customer to submit a change order ASR. Conversion of existing TPP service to a different TPP period will be allowed without application of any nonrecurring or ordering charges.

Conversion to month-to-month rates will be treated as a disconnect of service and establishment of new service. However, if no other changes are ordered, no charge will apply.

¹ Effective May 31, 2022, Frontier will no longer support Moves, Adds or Changes nor new installations for [Frame Relay] Service. Upon service term expiration, this service will transition to a Month-to-Month service arrangement. (D)
(N)
|
(N)

Applies to All Exchanges Illinois

FACILITIES FOR INTRASTATE ACCESS

16. ADVANCED COMMUNICATIONS NETWORKS (Cont'd)

16.3 Frame Relay Service – Grandfathered ¹ (Cont'd) (C)

(E) Rate Regulations (Cont'd)

(4) Term Payment Plan (TPP) (Cont'd)

(d) Notification of Discontinuance

An ASR for discontinuance of a TPP arrangement must be received by the Company at least 30 days prior to actual disconnect of service. Monthly charges will apply for a period of 30 days from the date the Company receives disconnect notification or until the requested disconnect date, whichever period is longer.

(e) Upgrade to Higher Speed Service

Customers may elect to upgrade service(s) to a higher speed during a TPP period, subject to the following conditions:

- The upgraded service will be subject to all appropriate nonrecurring charges.
- Termination liability charges will not apply as long as the upgraded service remains connected at the same point of termination(s) or meets the requirements set forth in Section 5.6.4(B)2.

(D)

¹ Effective May 31, 2022, Frontier will no longer support Moves, Adds or Changes nor new installations for [Frame Relay] Service. Upon service term expiration, this service will transition to a Month-to-Month service arrangement. (N)
|
(N)

Applies to All Exchanges Illinois

FACILITIES FOR INTRASTATE ACCESS

16. ADVANCED COMMUNICATIONS NETWORKS (Cont'd)

16.3 Frame Relay Service – Grandfathered ¹ (Cont'd) (C)

(E) Rate Regulations (Cont'd)

(4) Term Payment Plan (TPP) (Cont'd)

(f) Termination Liability

When a TPP arrangement is discontinued prior to the end of the period, termination liability charges, as set forth below, will apply based on the remainder of the TPP period in effect at the time of disconnect.

One Year TPP - 50% of any remaining portion of the first year's recurring charges for the in service quantity.

Three Year TPP - 50% of any remaining portion of the first year's recurring charges. In addition, for any remaining portion of the second and third years, the customer will be liable for 10% of the total monthly recurring charges in that time period for the in service quantity.

Five Year TPP - 50% of any remaining portion of the first year's recurring charges. In addition, for any remaining portion of the second through fifth years, the customer will be liable for 10% of the total monthly recurring charges in that time period for the in service quantity.

(g) Termination Without Liability

During a TPP period, should the currently effective rate for a customer's service increase, the customer may, at his/her option, terminate the TPP arrangement without penalty or liability.

¹ Effective May 31, 2022, Frontier will no longer support Moves, Adds or Changes nor new installations for [Frame Relay] Service. Upon service term expiration, this service will transition to a Month-to-Month service arrangement.

(D)
(N)
|
(N)

Applies to All Exchanges Illinois

FACILITIES FOR INTRASTATE ACCESS

16. ADVANCED COMMUNICATIONS NETWORKS (Cont'd)

16.3 Frame Relay Service – Grandfathered ¹ (Cont'd) (C)

(F) Rates

	<u>Nonrecurring Charge</u>	<u>Monthly Rate</u>
(1) <u>Frame Relay UNI Port and Access Line, each *</u>		
56 Kpbs		
Month to Month	\$ 195.00	\$ 110.00
One Year	195.00	105.00
Three Years	195.00	95.00
Five Years	195.00	85.00
384 Kpbs		
Month to Month	395.00	380.00
One Year	395.00	370.00
Three Years	395.00	355.00
Five Years	395.00	340.00
1.544 Mbps		
Month to Month	395.00	530.00
One Year	395.00	510.00
Three Years	395.00	490.00
Five Years	395.00	470.00
(2) <u>Frame Relay UNI Port Only, each #</u>		
56 Kpbs		
Month to Month	\$ 95.00	\$ 24.00
One Year	95.00	23.00
Three Years	95.00	22.00
Five Years	95.00	21.00

* Includes one PVC

Refer to Section 5 for the appropriate Special Access Line rate.

¹ Effective May 31, 2022, Frontier will no longer support Moves, Adds or Changes nor new installations for [Frame Relay] Service. Upon service term expiration, this service will transition to a Month-to-Month service arrangement. (N)
 |
 (N)

Applies to All Exchanges Illinois

FACILITIES FOR INTRASTATE ACCESS

16. ADVANCED COMMUNICATIONS NETWORKS (Cont'd)

16.3 Frame Relay Service – Grandfathered ¹ (Cont'd) (C)

(F) Rates

	Nonrecurring <u>Charge</u>	Monthly <u>Rate</u>
(2) <u>Frame Relay UNI Port Only, each #</u> (Cont'd)		
1.544 Mbps		
Month to Month	295.00	213.00
One Year	295.00	211.00
Three Years	295.00	208.00
Five Years	295.00	205.00

Refer to Section 5 for the appropriate Special Access Line rate.

¹ Effective May 31, 2022, Frontier will no longer support Moves, Adds or Changes nor new installations for [Frame Relay] Service. Upon service term expiration, this service will transition to a Month-to-Month service arrangement.

(D)
(N)
|
(N)

Applies to All Exchanges Illinois

FACILITIES FOR INTRASTATE ACCESS

16. ADVANCED COMMUNICATIONS NETWORKS (Cont'd)

16.3 Frame Relay Service – Grandfathered ¹ (Cont'd) (C)

(F) Rates (Cont'd)

	<u>Nonrecurring Charge</u>	<u>Monthly Rate</u>
(3) <u>Frame Relay NNI Port Only, each</u> *#		
384 Kpbs		
Month to Month	\$ 295.00	\$ 78.00
One Year	295.00	75.00
Three Years	295.00	72.00
Five Years	295.00	69.00
1.544 Mbps		
Month to Month	295.00	180.00
One Year	295.00	170.00
Three Years	295.00	160.00
Five Years	295.00	150.00
(4) <u>Frame Relay PVCs, each</u>		
Month to Month	\$ 20.00	\$ 8.00
One Year	20.00	7.00
Three Years	20.00	6.00
Five Years	20.00	5.00

* Includes one PVC

Refer to Section 5 for the appropriate Special Access Line rate.

¹ Effective May 31, 2022, Frontier will no longer support Moves, Adds or Changes nor new installations for [Frame Relay] Service. Upon service term expiration, this service will transition to a Month-to-Month service arrangement.

(D)
 (N)
 |
 (N)

Applies to All Exchanges Illinois

FACILITIES FOR INTRASTATE ACCESS

16. ADVANCED COMMUNICATIONS NETWORKS (Cont'd)

16.3 Frame Relay Service – Grandfathered ¹ (Cont'd) (C)

(F) Rates (Cont'd)

(5) Interzone CIR and Priority PVCs Based on CIR Requested *

	<u>Monthly Rate</u>
0 - 32 Kbps CIR	\$25.00
Priority 1	31.25
Priority 2	27.50
33 - 64 Kbps CIR	45.00
Priority 1	56.25
Priority 2	49.50
65 - 96 Kbps CIR	60.00
Priority 1	75.00
Priority 2	66.00
97 - 128 Kbps CIR	70.00
Priority 1	87.50
Priority 2	77.00
129 - 192 Kbps CIR	95.00
Priority 1	118.75
Priority 2	104.50
193 - 256 Kbps CIR	115.00
Priority 1	143.75
Priority 2	126.50

* PVCs which are deemed to be interstate in nature will fall under federal jurisdiction and the resulting CIR will be billed at rates specified in Frontier Telephone Companies Tariff FCC No. 8.

¹ Effective May 31, 2022, Frontier will no longer support Moves, Adds or Changes nor new installations for [Frame Relay] Service. Upon service term expiration, this service will transition to a Month-to-Month service arrangement.

(D)
 (N)
 |
 (N)

Issued: April 15, 2022

Effective: May 31, 2022

By Allison Ellis
 SVP Regulatory Affairs

Applies to All Exchanges Illinois

FACILITIES FOR INTRASTATE ACCESS

16. ADVANCED COMMUNICATIONS NETWORKS (Cont'd)

16.3 Frame Relay Service – Grandfathered ¹ (Cont'd) (C)

(F) Rates (Cont'd)

(5) Interzone CIR and Priority PVCs Based on CIR Requested * (Cont'd)

	<u>Monthly Rate</u>
257 - 320 Kbps CIR	\$130.00
Priority 1	162.50
Priority 2	143.00
321- 384 Kbps CIR	145.00
Priority 1	181.25
Priority 2	159.50
385 - 512 Kbps CIR	170.00
Priority 1	212.50
Priority 2	187.00
513 - 768 Kbps CIR	195.00
Priority 1	243.75
Priority 2	214.50
769 - 1152 Kbps CIR	225.00
Priority 1	281.25
Priority 2	247.50
1153 - 1536 Kbps CIR	250.00
Priority 1	312.50
Priority 2	275.00

* PVCs which are deemed to be interstate in nature will fall under federal jurisdiction and the resulting CIR will be billed at rates specified in Frontier Telephone Companies Tariff FCC No. 8.

¹ Effective May 31, 2022, Frontier will no longer support Moves, Adds or Changes nor new installations for [Frame Relay] Service. Upon service term expiration, this service will transition to a Month-to-Month service arrangement.

(D)
 (N)
 |
 (N)

Applies to All Exchanges Illinois

FACILITIES FOR INTRASTATE ACCESS

16. ADVANCED COMMUNICATIONS NETWORKS (Cont'd)

16.3 Frame Relay Service – Grandfathered ¹ (Cont'd)

(C)

(F) Rates (Cont'd)

(5) Interzone CIR and Priority PVCs Based on CIR Requested * (Cont'd)

	<u>Monthly Rate</u>
1537 - 4000 Kbps CIR	\$ 325.00
Priority 1	406.25
Priority 2	357.50
4001- 10000 Kbps CIR	710.00
Priority 1	887.50
Priority 2	781.00
10001 - 15000 Kbps CIR	1,000.00
Priority 1	1,250.00
Priority 2	1,100.00
15001 - 20000 Kbps CIR	1,250.00
Priority 1	1,562.50
Priority 2	1,375.00
20001 - 25000 Kbps CIR	1,475.00
Priority 1	1,843.75
Priority 2	1,622.50
25001 - 30000 Kbps CIR	1,675.00
Priority 1	2,093.75
Priority 2	1,842.50

* PVCs which are deemed to be interstate in nature will fall under federal jurisdiction and the resulting CIR will be billed at rates specified in Frontier Telephone Companies Tariff FCC No. 8.

¹ Effective May 31, 2022, Frontier will no longer support Moves, Adds or Changes nor new installations for [Frame Relay] Service. Upon service term expiration, this service will transition to a Month-to-Month service arrangement.

(D)

(N)

|

(N)

Applies to All Exchanges Illinois

FACILITIES FOR INTRASTATE ACCESS

16. ADVANCED COMMUNICATIONS NETWORKS (Cont'd)

16.3 Frame Relay Service – Grandfathered ¹ (Cont'd) (C)

(F) Rates (Cont'd)

(5) Interzone CIR and Priority PVCs Based on CIR Requested * (Cont'd)

	<u>Monthly Rate</u>
30001 - 35000 Kbps CIR	\$1,900.00
Priority 1	2,375.00
Priority 2	2,090.00
35001- 40000 Kbps CIR	2,150.00
Priority 1	2,687.50
Priority 2	2,365.00
40001 - 45000 Kbps CIR	2,375.00
Priority 1	2,968.75
Priority 2	2,612.50

* PVCs which are deemed to be interstate in nature will fall under federal jurisdiction and the resulting CIR will be billed at rates specified in Frontier Telephone Companies Tariff FCC No. 8.

¹ Effective May 31, 2022, Frontier will no longer support Moves, Adds or Changes nor new installations for [Frame Relay] Service. Upon service term expiration, this service will transition to a Month-to-Month service arrangement.

(D)
 (N)
 |
 (N)

Applies to All Exchanges Illinois

FACILITIES FOR INTRASTATE ACCESS

17. AGREEMENTS WITH TELECOMMUNICATIONS CARRIERS PURSUANT TO SECTIONS 251 AND 252 OF THE FEDERAL TELECOMMUNICATIONS ACT OF 1996.

<u>Docket No.</u>	<u>Expiration Date</u>	<u>Contracting Carrier</u>	(N)
97 NA-002	September 26, 1997	360 Communications Company of Peoria and Illinois Independent RSA No. 3 General Partnership, d/b/a 360 Communications Company	
97 NA-013	January 9, 1998	Sprint Spectrum L.P.	
97 NA-014	August 6, 1998	AT&T Wireless Services, Inc.	
97 NA-019	September 1, 1998	First Cellular of Southern Illinois	
97 PA-031	January 1, 1983*	Northwestern Bell	
97 PA-034	Upon 6 Months Notice	Central Telephone Company	
97 PA-036	February 25, 1994*	Central Telephone Company	
97 NA-018	September 12, 1998	Nextel Communications, Inc.	
97 PA-018	Upon 60 Days Notice	Illinois Bell Telephone Company	
97 PA-020	August 30, 1998	Illinois Bell Telephone Company	
97 NA-022	September 24, 1999	Ameritech	
97 NA-027	April 22, 1998	GTE Mobilnet of Indianapolis, Inc.	
97 NA-031	December 17, 1999	USA Exchange, LLC d/b/a Omniplex Communications Group	
97 NA-035	December 17, 1998	H.L.D. Cellular Corporation	
97 NA-036	January 7, 1999	Alton Celltelco Cellular Corporation	
97 NA-037	January 22, 1999	U.S. Cellular Corporation	

* Termination may be initiated by either party in accordance with the terms and conditions of the agreement.

Applies to All Exchanges Illinois

FACILITIES FOR INTRASTATE ACCESS

17. AGREEMENTS WITH TELECOMMUNICATIONS CARRIERS PURSUANT TO SECTIONS 251 AND 252 OF THE FEDERAL TELECOMMUNICATIONS ACT OF 1996.

<u>Docket No.</u>	<u>Expiration Date</u>	<u>Contracting Carrier</u>
98 NA-001	September 11, 1998	GTE Communications Corporation
98 NA-008	May 6, 2000	Local Line America, Incorporated
98 NA-009	June 3, 2000	Dekota Services, Limited
98 NA-010	June 17, 2000	Cambridge Telcom Service, Inc.
98 NA-011	July 22, 1999	Ameritech Mobile Communications, Inc.
98 NA-025	September 16, 2000	360 Communications Company
98 NA-026	September 16, 1999	Pre-Paid Local Access Phone Service Company
98 NA-029	October 28, 2000	DMJ Communications, Inc.
98 NA-032	October 28, 1999	Amica Wireless Phone Service, Inc.
98 NA-036	December 23, 2000	Camarato Distributing, Inc.
98 NA-038	December 23, 2000	Eagle Communications, Inc.
98 NA-042	February 3, 2001	US Xchange of Illinois, LLC
99 NA-001	February 18, 2000	Nextel West Corp.
99 NA-003	April 7, 2001	United States Telecommunications, Inc.
99 NA-005	April 21, 2001	LDD Incorporated
99 NA-007	May 19, 2001	dPi-Teleconnect, L.L.C.

* Termination may be initiated by either party in accordance with the terms and conditions of the agreement.

Issued: August 28, 2014

Effective: October 12, 2014

By Jack D. Phillips
State Government and Regulatory Affairs Director

(N)

(N)

Applies to All Exchanges Illinois

FACILITIES FOR INTRASTATE ACCESS

17. AGREEMENTS WITH TELECOMMUNICATIONS CARRIERS PURSUANT TO SECTIONS 251 AND 252 OF THE FEDERAL TELECOMMUNICATIONS ACT OF 1996.

<u>Docket No.</u>	<u>Expiration Date</u>	<u>Contracting Carrier</u>
99 AA-001	June 28, 2002	AT&T Communications of Illinois, Inc.
99 NA-016	July 28, 2000	PrimeCo Personal Communications, L.P.
99 NA-012	February 3, 2001	MTCO Communications, Inc.
99 NA-019	February 3, 2001	Hyperion Communications of Illinois, Inc.
99 NA-020	February 3, 2001	Egyptian Communication Services, Inc.
99 NA-021	February 3, 2001	Adams TelSystems, Inc.
99 NA-025	February 3, 2001	Oneida Network Services, Inc.
99 NA-026	February 3, 2001	Essex Telecom, Inc.
99 NA-027	September 22, 2001	Digital Pipeline Communications, Inc.
99 NA-049	October 24, 2001	Mebtel Integration Communications Solutions, Inc
99 NA-039	June 30, 2001	AT&T Wireless Services, Inc.
99 NA-041	October 8, 2001	Now Communications Incorporated
99 NA-044	February 3, 2001	McLeodUSA Telecommunications Services, Inc.
99 NA-045	August 3, 2001	Vast-Tel Communications, Inc.
99 NA-050	February 3, 2001	Flat Rock Communications, Inc.
99 NA-051	July 30, 2000	Sprint Spectrum L.P.
99 NA-052	February 1, 2002	NorthPoint Communications Incorporated

* Termination may be initiated by either party in accordance with the terms and conditions of the agreement.

Issued: August 28, 2014

Effective: October 12, 2014

By Jack D. Phillips
State Government and Regulatory Affairs Director

(N)

(N)

Applies to All Exchanges Illinois

FACILITIES FOR INTRASTATE ACCESS

17. AGREEMENTS WITH TELECOMMUNICATIONS CARRIERS PURSUANT TO SECTIONS 251 AND 252 OF THE FEDERAL TELECOMMUNICATIONS ACT OF 1996.

<u>Docket No.</u>	<u>Expiration Date</u>	<u>Contracting Carrier</u>
00-0023	June 28, 2002	BlueStar Networks, Inc.
00-0022	December 3, 2001	Comm South Companies, Inc.
00-0004	December 23, 2001	GlobalEyes Telecommunications, Inc.
00-0059	September 4, 2000	NPCR, Inc.
00-0060	March 15, 2002	Choctaw Communications, Inc. d/b/a Smoke Signal Communications
00-0153	February 3, 2001	O1 Communications of Illinois, LLC
00-0203	February 3, 2001	Home TeleNetworks, Inc.
00-0204	February 3, 2001	Wabash Independent Networks, Inc.
00-0205	February 3, 2001	Diverse Communications, Inc.
00-0129	June 28, 2002	PVTel
00-0225	February 3, 2001	Hamilton County Communications, Inc.
00-0221	Subject to 180 days termination notice, per contract	Illinois Bell Telephone Company, d/b/a Ameritech Illinois
00-0267	June 28, 2002	Max-Tel Communications, Inc.
00-0268	June 15, 2002	Jato Operating Two Corp.
00-0317	April 15, 2002	U.S. Dial Tone, L. P.

* Termination may be initiated by either party in accordance with the terms and conditions of the agreement.

Issued: August 28, 2014

Effective: October 12, 2014

By Jack D. Phillips
State Government and Regulatory Affairs Director

(N)

(N)

Applies to All Exchanges Illinois

FACILITIES FOR INTRASTATE ACCESS

17. AGREEMENTS WITH TELECOMMUNICATIONS CARRIERS PURSUANT TO SECTIONS 251 AND 252 OF THE FEDERAL TELECOMMUNICATIONS ACT OF 1996.

<u>Docket No.</u>	<u>Expiration Date</u>	<u>Contracting Carrier</u>
00-0392	June 3, 2000	@link Networks, Inc. f/k/a Dakota Services Limited First Amendment
00-0429	March 31, 2002	Metromedia Fiber Network Services, Inc.
00-0430	February 1, 2002	Aero Communications, LLC
00-0459	December 31, 2002	New Edge Network, Inc. d/b/a New Edge Networks
00-0460	February 1, 2002	NorthPoint Communications Incorporated Line Sharing Amendment
00-0471	February 1, 2002	Bell Atlantic Network Data, Inc.
00-0472	February 1, 2002	Bell Atlantic Network Data, Inc. First Supplement
00-0565	December 31, 2002	New Edge Network, Inc. d/b/a New Edge Network Line Sharing Amendment
00-0566	August 31, 2002	Cat Communications International, Inc. d/b/a CCI
00-0567	February 1, 2002	Aero Communications, Inc. Supplement
00-0568	February 3, 2001	Grafton Technologies, Inc.
00-0569	December 31, 2002	MAXCESS, Inc.
00-0570	February 3, 2001	MTCO Communications, Inc, Supplement
00-0571	June 28, 2002	Sprint Communications Company LP d/b/a Sprint Communications LP

* Termination may be initiated by either party in accordance with the terms and conditions of the agreement.

Issued: August 28, 2014

Effective: October 12, 2014

By Jack D. Phillips
State Government and Regulatory Affairs Director

(N)

(N)

Applies to All Exchanges Illinois

FACILITIES FOR INTRASTATE ACCESS

17. AGREEMENTS WITH TELECOMMUNICATIONS CARRIERS PURSUANT TO SECTIONS 251 AND 252 OF THE FEDERAL TELECOMMUNICATIONS ACT OF 1996.

<u>Docket No.</u>	<u>Expiration Date</u>	<u>Contracting Carrier</u>
00-0614	September 4, 2000	Telecorp Communications, Inc.
00-0615	September 15, 2002	Pathnet, Inc.
00-0667	June 30, 2001	First Cellular of Southern Illinois
00-0709	September 15, 2002	ServiSense.com, Inc.
01-0016	June 28, 2002	Supra Telecommunications & Information Systems, Inc.
01-0124	January 15, 2003	ReFlex Communications, Inc.
01-0275	January 15, 2003	Direct2Internet Corporation
01-0429	February 1, 2002	Verizon Advanced Data, Inc. (3rd Supplement)
01-0428	June 28, 2002	Z-Tel Communications, Inc.
01-0493	July 31, 2003	Bitwise Communications, Inc.
01-0578	June 4, 2003	NOS Communications, Inc.
01-0579	December 30, 2001	AT&T Wireless, Inc. (First Amendment)
01-0580	January 15, 2003	Premiere Network Services
01-0613	April 30, 2003	1-800-RECONEX, Inc.
01-0652	August 23, 2003	Now Communications, Inc.
01-0653	September 24, 2003	Ciera Network Systems, Inc.
01-0638	April 15, 2002	KMC Telecom V, Inc.

* Termination may be initiated by either party in accordance with the terms and conditions of the agreement.

Issued: August 28, 2014

Effective: October 12, 2014

By Jack D. Phillips
State Government and Regulatory Affairs Director

(N)

(N)

Applies to All Exchanges Illinois

FACILITIES FOR INTRASTATE ACCESS

17. AGREEMENTS WITH TELECOMMUNICATIONS CARRIERS PURSUANT TO SECTIONS 251 AND 252 OF THE FEDERAL TELECOMMUNICATIONS ACT OF 1996.

<u>Docket No.</u>	<u>Expiration Date</u>	<u>Contracting Carrier</u>
01-0684	December 30, 2001	VoiceStream Wireless Corporation
01-0685	July 28, 2002	TMP Corp.
01-0686	August 21, 2003	Preferred Carrier Services, Inc. d/b/a Phones For All and Telefonos Para Todos
01-0813	September 11, 2003	IG2, Inc.
01-0814	June 28, 2002	Aero Communications, LLC
01-0815	September 30, 2003	Adams TelSystems, Inc.
01-0816	April 15, 2002	PNG Telecommunications, Inc. d/b/a Powernet Global Communications
01-0817	August 31, 2003	MTCO Communications Inc.
01-0782	October 31, 2003	Hamilton County Communications, Inc.
01-0812	June 30, 2002	Metromedia Fiber Network Systems, Inc.
02-0120	January 14, 2004	Winco, Inc.
02-0037	June 30, 2002	VoiceStream Wireless Corporation
02-0038	September 30, 2003	Egyptian Communications, Inc.
02-0181	June 28, 2002	North County Communications Corporation
02-0107	June 28, 2002	IlliCom Telecommunications, Inc.
02-0108	November 27, 2003	VarTec Telecom, Inc. d/b/a VarTec Telecom
02-0182	September 4, 2002	NPCR, Inc. Second Amendment

* Termination may be initiated by either party in accordance with the terms and conditions of the agreement.

(N)

(N)

Applies to All Exchanges Illinois

FACILITIES FOR INTRASTATE ACCESS

17. AGREEMENTS WITH TELECOMMUNICATIONS CARRIERS PURSUANT TO SECTIONS 251 AND 252 OF THE FEDERAL TELECOMMUNICATIONS ACT OF 1996.

<u>Docket No.</u>	<u>Expiration Date</u>	<u>Contracting Carrier</u>
02-0183	September 4, 2002	Nextel West Corp. First Amendment
02-0190	September 4, 2002	Nextel West Corp. Second Amendment
02-0259	September 4, 2002	NPCR, Inc. d/b/a Nextel Partners First Amendment
02-0250	January 28, 2004	Synopsis Communications, Inc.
02-0251	June 28, 2002	Aero Communications, LLC First Amendment
02-0255	September 4, 2002	Telecorp Communications, Inc. First Amendment
02-0256	March 14, 2004	Delta Phones, Inc.
02-0257	August 23, 2003	Digital Telecommunications, Inc. d/b/a DTI
02-0258	March 3, 2004	Snappy Phone of Texas, Inc.
02-0281	April 30, 2003	1-800-RECONEX, Inc. First Amendment
02-0282	June 30, 2002	First Cellular of Southern Illinois First Amendment
02-0283	September 4, 2002	Illinois Valley Cellular RSA 2, Inc.
02-0284	October 31, 2003	Flat Rock Communications, Inc.
02-0374	April 4, 2004	Verizon Select Services, Inc.

* Termination may be initiated by either party in accordance with the terms and conditions of the agreement.

Issued: August 28, 2014

Effective: October 12, 2014

By Jack D. Phillips
State Government and Regulatory Affairs Director

(N)

(N)

Applies to All Exchanges Illinois

FACILITIES FOR INTRASTATE ACCESS

17. AGREEMENTS WITH TELECOMMUNICATIONS CARRIERS PURSUANT TO SECTIONS 251 AND 252 OF THE FEDERAL TELECOMMUNICATIONS ACT OF 1996.

<u>Docket No.</u>	<u>Expiration Date</u>	<u>Contracting Carrier</u>
02-0395	July 28, 2002	Chicago 20 MHZ, LLC d/b/a Wireless Communications, LLC as Assignee of Primeco Personal Communications, LP
02-0381	September 24, 2003	Level 3 Communications, LLC
02-0400	January 30, 2003	Sprint Spectrum L.P., d/b/a Sprint PCS
02-0412	October 31, 2003	Home Telenetworks, Inc.
02-0429	November 30, 2002	Metro Teleconnect Companies, Inc. d/b/a Metro Teleconnect
02-0440	January 30, 2003	WirelessCo L.P. by and through its General Partner and Agent Sprint Spectrum L.P.
02-0464	June 14, 2004	DMJ Communications, Inc.
02-0465	June 28, 2003	Comm South Companies, Inc.
02-0466	September 24, 2003	Ciera Network Systems, Inc.
02-0457	December 30, 2002	AT&T Wireless Services, Inc.
02-0458	March 4, 2003	Southwestern Bell Mobile Systems, LLC d/b/a Cingular Wireless
02-0459	March 4, 2003	Champaign CellTelCo d/b/a Cingular Wireless
02-0578	July 29, 2004	Kentucky Data Link, Inc. d/b/a Cinergy Networks
02-0532	June 2, 2004	Excel Telecommunications, Inc. d/b/a Excel
02-0580	August 31, 2003	MTCO Communications, Inc. (Amendment)

* Termination may be initiated by either party in accordance with the terms and conditions of the agreement.

Issued: August 28, 2014

Effective: October 12, 2014

By Jack D. Phillips
State Government and Regulatory Affairs Director

(N)

(N)

Applies to All Exchanges Illinois

FACILITIES FOR INTRASTATE ACCESS

17. AGREEMENTS WITH TELECOMMUNICATIONS CARRIERS PURSUANT TO SECTIONS 251 AND 252 OF THE FEDERAL TELECOMMUNICATIONS ACT OF 1996.

<u>Docket No.</u>	<u>Expiration Date</u>	<u>Contracting Carrier</u>
02-0652	June 4, 2004	Talk Unlimited Now, Inc.
02-0803	November 21, 2004	Global NAPs Illinois, Inc.
02-0670	July 29, 2003	US Cellular Corporation
02-0707	March 4, 2003	Telecorp Communications, Inc.
02-0752	March 29, 2003	Cellco Partnership d/b/a Verizon Wireless GTE Wireless of the Midwest d/b/a Verizon Wireless Illinois RSA 1 Limited Partnership d/b/a Verizon Wireless Indiana RSA #1 Limited Partnership d/b/a Verizon Wireless Rockford MSA Limited Partnership d/b/a Verizon Wireless
02-0861	September 24, 2003	Level 3 Communications, LLC
02-0862	November 19, 2004	Camarato Distributing, Inc. d/b/a New-Phon
02-0863	September 3, 2004	Bullseye Telecom, Inc.
03-0080	April 15, 2004	Sprint Communications Company L.P. d/b/a Sprint Communications L.P.
03-0178	January 30, 2005	CAT Communications International, Inc.
03-0307	April 15, 2004	Access2Go, Inc.
03-0330	April 15, 2004	Metropolitan Telecommunications of Illinois, Inc. d/b/a MetTel
03-0383	June 20, 2004	ICG Telecom Group, Inc.

* Termination may be initiated by either party in accordance with the terms and conditions of the agreement.

Issued: August 28, 2014

Effective: October 12, 2014

By Jack D. Phillips
State Government and Regulatory Affairs Director

(N)

(N)

Applies to All Exchanges Illinois

FACILITIES FOR INTRASTATE ACCESS

17. AGREEMENTS WITH TELECOMMUNICATIONS CARRIERS PURSUANT TO SECTIONS 251 AND 252 OF THE FEDERAL TELECOMMUNICATIONS ACT OF 1996.

<u>Docket No.</u>	<u>Expiration Date</u>	<u>Contracting Carrier</u>
03-0358	July 29, 2004	Delta Communications, LLC d/b/a Clearwave Communications
03-0405	June 28, 2004	Egix Network Services, Inc.
03-0441	September 30, 2003	Adams TelSystems, Inc.
03-0526	January 1, 2004	GlobalEyes Telecommunications, Inc.
03-0527	June 20, 2004	MCI WorldCom Communications, Inc.
03-0528	June 20, 2004	Intermedia Communications, Inc.
03-0529	January 8, 2005	Route24 Computers, Inc.
03-0559	June 20, 2004	Cypress Communications Operating Company, Inc.
03-0560	June 20, 2004	Cypress Communications Operating Company, Inc. (First Amendment)
03-0671	June 28, 2004	XO Illinois, Inc.
03-0744	September 3, 2004	American Farm Bureau, Inc. d/b/a The Farm Bureau Connection
04-0049	June 20, 2007	Intermedia Communications, Inc.
04-0050	June 20, 2004	MCI Worldcom Communications, Inc.
04-0057	November 19, 2004	Granite Telecommunications, LLC
04-0058	June 20, 2004	Cypress Communications Operating Company, Inc.
04-0326	June 28, 2004	New Millennium Telecommunications, Inc.
04-0247	April 15, 2004	Volo Communications of Illinois, Inc.

* Termination may be initiated by either party in accordance with the terms and conditions of the agreement.

(N)

(N)

Applies to All Exchanges Illinois

FACILITIES FOR INTRASTATE ACCESS

17. AGREEMENTS WITH TELECOMMUNICATIONS CARRIERS PURSUANT TO SECTIONS 251 AND 252 OF THE FEDERAL TELECOMMUNICATIONS ACT OF 1996.

<u>Docket No.</u>	<u>Expiration Date</u>	<u>Contracting Carrier</u>
04-0252	March 2, 2006	PNG Telecommunications d/b/a Powernet Global Communications
04-0288	January 30, 2005	CAT Communications International, Inc.
04-0338	March 2, 2006	Think 12 Corporation d/b/a/ Hello Depot
04-0337	March 2, 2006	Think 12 Corporation d/b/a/ Hello Depot (Amendment)
04-0341	July 29, 2004	Big River Telephone Company, LLC
04-0448	May 23, 2006	Century Tel Fiber Company II, LLC d/b/a Lightcore
04-0437	December 30, 2004	Southern Illinois RSA Partnership d/b/a First Cellular of Southern Illinois
04-0443	June 28, 2005	Essex Telecom, Inc.
04-0449	May 23, 2006	CenturyTel Fiber Company II, LLC d/b/a Lightcore (First Amendment)
04-0503	September 3, 2004	GlobalEyes Telecommunications, Inc.
04-0581	June 28, 2005	TCG Chicago and TCG Illinois
04-0616	April 24, 2005	Madison River Communications, LLC d/b/a/ Gallatin River Integrated Communications Solutions f/k/a MEBTEL Integrated Communications Solutions, LLC

* Termination may be initiated by either party in accordance with the terms and conditions of the agreement.

Issued: August 28, 2014

Effective: October 12, 2014

By Jack D. Phillips
State Government and Regulatory Affairs Director

(N)

(N)

Applies to All Exchanges Illinois

FACILITIES FOR INTRASTATE ACCESS

17. AGREEMENTS WITH TELECOMMUNICATIONS CARRIERS PURSUANT TO SECTIONS 251 AND 252 OF THE FEDERAL TELECOMMUNICATIONS ACT OF 1996.

<u>Docket No.</u>	<u>Expiration Date</u>	<u>Contracting Carrier</u>
04-0617	January 15, 2005	Metropolitan Telecommunications of Illinois, Inc.
04-0619	January 22, 2005	Cellco Partnership d/b/a Verizon Wireless
04-0620	January 22, 2005	Cellco Partnership d/b/a Verizon Wireless
04-0621	December 19, 2000 (continues until cancelled)	Cellco Partnership d/b/a Verizon Wireless
04-0622	December 19, 2000 (continues until cancelled)	Cellco Partnership d/b/a Verizon Wireless
04-0623	April 29, 2000 (continues until cancelled)	Cellco Partnership d/b/a Verizon Wireless and GTE Wireless of the Midwest Incorporated
04-0624	April 29, 2000 (continues until cancelled)	Cellco Partnership d/b/a Verizon Wireless and GTE Wireless of the Midwest Incorporated
04-0625	January 20, 2005	Cellco Partnership d/b/a Verizon Wireless
04-0655	June 28, 2005	AT&T Communications of Illinois, Inc.
04-0656	June 28, 2005	AT&T Communications of Illinois, Inc.
04-0657	June 28, 2005	American Fiber Network, Inc. d/b/a 'AFN'
04-0690	January 1, 2007	Level 3 Communications, L.L.C.
04-0715	April 14, 2006	CloseCall America, Inc.
04-0713	April 15, 2005	KMC Telecom V Inc.
04-0714	April 14, 2006	CloseCall America, Inc.

* Termination may be initiated by either party in accordance with the terms and conditions of the agreement.

Issued: August 28, 2014

Effective: October 12, 2014

By Jack D. Phillips
State Government and Regulatory Affairs Director

(N)

(N)

Applies to All Exchanges Illinois

FACILITIES FOR INTRASTATE ACCESS

17. AGREEMENTS WITH TELECOMMUNICATIONS CARRIERS PURSUANT TO SECTIONS 251 AND 252 OF THE FEDERAL TELECOMMUNICATIONS ACT OF 1996.

<u>Docket No.</u>	<u>Expiration Date</u>	<u>Contracting Carrier</u>
04-0617	April 15, 2005	Metropolitan Telecommunications of Illinois, Inc.
04-0776	June 28, 2005	TCG Chicago and TCG Illinois
04-0777	June 28, 2005	AT&T Communications of Illinois, Inc.
04-0790	June 28, 2005	Comcast Phone of Illinois, LLC d/b/a Comcast Digital Phone
04-0791	June 28, 2005	Comcast Phone of Illinois, LLC d/b/a Comcast Digital Phone
05-0026	December 19, 2006	Digital Network Access Communications, Inc.
05-0097	January 30, 2007	Symatec Communications, LLC
05-0098	January 11, 2007	Norlight Telecommunications, Inc.
05-0146	January 11, 2007	Norlight Telecommunications, Inc. (Amendment)
05-0127	March 31, 2008	TelCove Operations, Inc.
05-0223	June 28, 2005	TelNet-IL, LLC
05-0309	July 29, 2004 ¹	Delta Communications, LLC d/b/a Clearwave Communications
05-0315	June 28, 2006	Volo Communications of Illinois, Inc.
05-0372	September 4, 2005	Cellular Properties, Inc.
05-0373	July 28, 2006	TMP Corp. (Amendment)

¹ Agreement continues in force and effect after this date until notice of termination.

Applies to All Exchanges Illinois

FACILITIES FOR INTRASTATE ACCESS

17. AGREEMENTS WITH TELECOMMUNICATIONS CARRIERS PURSUANT TO SECTIONS 251 AND 252 OF THE FEDERAL TELECOMMUNICATIONS ACT OF 1996.

<u>Docket No.</u>	<u>Expiration Date</u>	<u>Contracting Carrier</u>
05-0374	July 28, 2006	TMP Corp. (Amendment)
05-0377	June 28, 2006	Charter Fiberlink-Illinois, LLC
05-0414	June 28, 2006	Aero Communications, LLC
05-0499	June 6, 2007	Trans National Communications International, Inc.
05-0539	June 6, 2007	Trans National Communications International, Inc. (Amendment)
05-0546	July 29, 2000 ¹	United States Cellular Operating Company of Chicago, LLC; USCOC of Central Illinois, LLC; USCOC of Illinois RSA #1, LLC; USCOC of Illinois RSA #4, LLC; and USCOC of Rockford, LLC (Amendment 3)
05-0547	July 29, 2000 ¹	United States Cellular Operating Company of Chicago, LLC; USCOC of Central Illinois, LLC; USCOC of Illinois RSA #1, LLC; USCOC of Illinois RSA #4, LLC; and USCOC of Rockford, LLC (Amendment 2)
05-0593	June 20, 2006	MCIMETRO Access Transmission Services LLC, as successor to MCI Worldcom Communications, Inc. (Amendment 2)
05-0594	June 20, 2006	MCIMETRO Access Transmission Services LLC, as successor to MCI Worldcom Communications, Inc. (Amendment 3)
05-0595	June 20, 2006	MCIMETRO Access Transmission Services LLC, as successor to Intermedia Communications LLC (Amendment 2)

¹ Agreement continues in force and effect after this date until notice of termination.

Applies to All Exchanges Illinois

FACILITIES FOR INTRASTATE ACCESS

17. AGREEMENTS WITH TELECOMMUNICATIONS CARRIERS PURSUANT TO SECTIONS 251 AND 252 OF THE FEDERAL TELECOMMUNICATIONS ACT OF 1996.

<u>Docket No.</u>	<u>Expiration Date</u>	<u>Contracting Carrier</u>
05-0596	June 20, 2006	MCIMETRO Access Transmission Services LLC, as successor to Intermedia Communications LLC (Amendment 3)
05-0777	June 28, 2006	EGIX Network Services, Inc. (Amendment)
05-0798	September 20, 2003 ¹	Adams TelSystems, Inc. (Amendment)
05-0818	June 28, 2006	AT&T Communications of Illinois Inc. (Amendment)
05-0819	June 28, 2006	TCG Chicago and TCG Illinois (Amendment)
06-0053	November 30, 2007	Navigator Telecommunications, LLC
06-0054	November 30, 2007	Navigator Telecommunications, LLC (Amendment)
06-0055	November 30, 2007	Navigator Telecommunications, LLC (Amendment)
06-0114	September 26, 2007	France Telecom Corporate Solutions, LLC
06-0115	December 25, 2007	Covista, Inc.
06-0117	December 25, 2007	Covista, Inc. (Amendment)
06-0118	December 25, 2007	Covista, Inc. (Amendment 2)

¹ Agreement continues in force and effect after this date until notice of termination.

(N)

(N)

Applies to All Exchanges Illinois

FACILITIES FOR INTRASTATE ACCESS

17. AGREEMENTS WITH TELECOMMUNICATIONS CARRIERS PURSUANT TO SECTIONS 251 AND 252 OF THE FEDERAL TELECOMMUNICATIONS ACT OF 1996.

<u>Docket No.</u>	<u>Expiration Date</u>	<u>Contracting Carrier</u>
06-0184	February 1, 2008	Easton Telecom Services, L.L.C.
06-0374	April 17, 2008	Ernest Communications, Inc.
06-0375	April 17, 2008	Ernest Communications, Inc. (Amendment)
06-0461	May 30, 2008	YMax Communications Corp.
06-0462	May 30, 2008	YMax Communications Corp. (Amendment)
06-0463	May 28, 2008	Insight Phone of Illinois, LLC d/b/a Insight Phone
06-0464	May 28, 2008	Insight Phone of Illinois, LLC d/b/a Insight Phone (Amendment)
06-0516	June 28, 2008	Iowa Wireless Services, LLC d/b/a i wireless and Iowa Wireless Services Holding Corporation
06-0565	June 13, 2008	KMC Data LLC
06-0566	June 13, 2008	KMC Data LLC (Amendment)
06-0653	June 28, 2007	Charter Fiberlink-Illinois, LLC
06-0654	June 28, 2007	Charter Fiberlink-Illinois, LLC (Amendment)
06-0642	December 19, 2006	Digital Network Access Communications, Inc. (Amendment)
06-0724	October 16, 2008	Globetel, Inc.

¹ Agreement continues in force and effect after this date until notice of termination.

Applies to All Exchanges Illinois

FACILITIES FOR INTRASTATE ACCESS

17. AGREEMENTS WITH TELECOMMUNICATIONS CARRIERS PURSUANT TO SECTIONS 251 AND 252 OF THE FEDERAL TELECOMMUNICATIONS ACT OF 1996.

<u>Docket No.</u>	<u>Expiration Date</u>	<u>Contracting Carrier</u>
06-0793	November 2, 2008	Clear Rate Communications, Inc.
07-0275	April 5, 2009	Airespring, Inc.
07-0243	February 27, 2009	dPi Teleconnect, L. L. C. (dPi)
07-0244	March 25, 2009	Cost Plus Communications, LLC
07-0347	March 27, 2009	Cinergy Communications Company
07-0348	July 31, 2003 ¹	BITWISE Communications, Inc. (Amendment)
07-0349	July 31, 2003 ¹	BITWISE Communications, Inc. (Amendment)
07-0582	November 27, 2009	Marion Telephone LLC
07-0583	November 27, 2009	Marion Telephone LLC (Amendment)
08-0034	October 21, 2009	Sterling Telecom, Inc.
08-0050	May 28, 2008	Insight Phone of Illinois, LLC d/b/a Insight Phone (Amendment)
08-0035	June 28, 2007 ¹	TCG St. Louis
08-0043	June 28, 2008	360networks (USA) inc.
08-0120	January 20, 2010	Wholesale Carrier Services, Inc.
08-0064	April 15, 2004 ¹	Metropolitan Telecommunicatons of Illinois, Inc. d/b/a MetTel (Amendment)
08-0199	February 28, 2010	Bandwidth.com CLEC, LLC

(N)

(N)

¹ Agreement continues in force and effect after this date until notice of termination.

Applies to All Exchanges Illinois

FACILITIES FOR INTRASTATE ACCESS

17. AGREEMENTS WITH TELECOMMUNICATIONS CARRIERS PURSUANT TO SECTIONS 251 AND 252 OF THE FEDERAL TELECOMMUNICATIONS ACT OF 1996.

<u>Docket No.</u>	<u>Expiration Date</u>	<u>Contracting Carrier</u>
08-0206	August 31, 2003 ¹	MTCO Communications, Inc. (Amendment)
08-0186	June 28, 2007 ¹	CommPartners, LLC
08-0286	February 27, 2009	Momentum Telecom, Inc.
08-0313	April 28, 2010	Telrite Corporation
08-0421	June 18, 2008 ¹	Madison River Communications, LLC d/b/a Gallatin River Integrated Communications Solutions (Amendment)
08-0422	June 18, 2008 ¹	Madison River Communications, LLC d/b/a Gallatin River Integrated Communications Solutions (Amendment)
08-0423	April 13, 2010	PNG Telecommunications, Inc. d/b/a Powernet Global Communications
08-0424	April 13, 2010	PNG Telecommunications, Inc. d/b/a Powernet Global Communications (Amendment)
08-0452	March 27, 2009	Aero Communications, LLC
08-0531	August 21, 2010	Access Point, Inc.
08-0566	December 31, 2009	Denali Spectrum Operations, LLC d/b/a Cricket
08-0567	December 31, 2009	Denali Spectrum Operations, LLC d/b/a Cricket (Amendment)

¹ Agreement continues in force and effect after this date until notice of termination.

Applies to All Exchanges Illinois

FACILITIES FOR INTRASTATE ACCESS

17. AGREEMENTS WITH TELECOMMUNICATIONS CARRIERS PURSUANT TO SECTIONS 251 AND 252 OF THE FEDERAL TELECOMMUNICATIONS ACT OF 1996.

<u>Docket No.</u>	<u>Expiration Date</u>	<u>Contracting Carrier</u>
08-0667	October 13, 2010	McGraw Communications, Inc.
09-0038	December 31, 2009	XO Communications Services, Inc. (Amendment)
09-0039	December 31, 2009	Denali Spectrum Operations, LLC d/b/a Cricket (Amendment)
09-0148	February 17, 2011	D-Max, Inc.
09-0208	February 28, 2010	Aero North Communications, Inc.
09-0214	October 1, 2008 ¹	Denali Spectrum Operations, LLC d/b/a Cricket (Amendment)
09-0374	May 30, 2008 ¹	NET TALK.COM, INC.
09-0376	June 30, 2011	Denali Spectrum Operations, LLC d/b/a Cricket
09-0377	June 30, 2011	Denali Spectrum Operations, LLC d/b/a Cricket (Amendment)
09-0387	August 6, 2010	iNETWORKS Group, Inc.

¹ Agreement continues in force and effect after this date until notice of termination.

(N)

(N)

Applies to All Exchanges Illinois

FACILITIES FOR INTRASTATE ACCESS

17. AGREEMENTS WITH TELECOMMUNICATIONS CARRIERS PURSUANT TO SECTIONS 251 AND 252 OF THE FEDERAL TELECOMMUNICATIONS ACT OF 1996.

<u>Docket No.</u>	<u>Expiration Date</u>	<u>Contracting Carrier</u>	(M)	
09-0410	August 27, 2011	New Horizons Communications Corp. d/b/a/ NHC Communications Inc.		
09-0421	September 7, 2011	Enteleagent Solutions, Inc.		
09-0550	October 22, 2011	Lightyear Network Solutions, LLC		
09-0565	September 3, 2011	BLC Management LLC d/b/a Angles Communication Solutions d/b/a Mexicall Solutions		
10-0416	December 31, 2012	Intrado Inc.		
10-0418	June 17, 2012	Dynalink Communications, Inc.		
10-0419	December 2, 2011	Telecom Management, Inc. d/b/a Pioneer Telephone		
10-0420	November 29, 2011	MTC Communications, Inc.		
11-0585	December 12, 2012	Birch Telecom of the Great Lakes, Inc. d/b/a Birch Communications		
11-0748	September 1, 2013	Illinois Network Alliance, LLC		
12-0087	June 17, 2012	Cygnus Telecommunications Corporation		
12-0558	December 1, 2013	Syndeo Networks, Inc.		
12-0514	July 1, 2013	Comcast Phone of Illinois, LLC.		
13-0065	July 1, 2014	Comcast Phone of Illinois, LLC.		
13-0068	March 20, 2015	American Broadband and Telecommunications Company		
13-0300	June 18, 2013	PEG Bandwidth IL, LLC		
13-0677	October 25, 2015	ALEC, LLC		
13-0666	October 1, 2015	INdigital Telecom		(M)

Issued: August 28, 2014

Effective: October 12, 2014

By Jack D. Phillips
State Government and Regulatory Affairs Director

Applies to All Exchanges Illinois

FACILITIES FOR INTRASTATE ACCESS

17. AGREEMENTS WITH TELECOMMUNICATIONS CARRIERS PURSUANT TO SECTIONS 251 AND 252 OF THE FEDERAL TELECOMMUNICATIONS ACT OF 1996.

<u>Docket No.</u>	<u>Expiration Date</u>	<u>Contracting Carrier</u>	
14-0478	until terminated	Adams TelSystems, Inc.	
14-0479	until terminated pursuant to the terms of the agreement	Millennium 2000 Inc.	
14-0519	6 month increments/ or until one of the parties cancels	SprintCom, Inc.	
14-0541	until terminated	HTC Communications Co.	
14-0613	when cancelled by either party	United States Cellular Operating Company of Chicago, LLC	
14-0613	when cancelled by either party	USCOC of Central Illinois, LLC	
14-0600	when cancelled by either party	Metro Communications Company, Inc.	
14-0535	when cancelled by either party	New Cingular Wireless, PCS, LLC	
14-0637	when cancelled by either party	Cincinnati Bell Any Distance, Inc.	
14-0655	when cancelled by either party	New Horizons Communications Corp. d/b/a NHC Communications, Inc.	
14-0699	when cancelled by either party	NOS Communications, Inc.	
15-0233	when cancelled by either party	Adams TelSystems, Inc.	(N)
15-0111	when cancelled by either party	Spectrotel	(N)

Applies to All Exchanges Illinois

FACILITIES FOR INTRASTATE ACCESS

SECTION 18 TABLE OF CONTENTS

<u>18. RATE ZONE WIRE CENTERS</u>	<u>PAGE</u>
18.1 General.....	2
18.2 GTE/Former Alltel Wire Centers	6
18.3 Former Contel Wire Centers	14

Applies to All Exchanges Illinois

FACILITIES FOR INTERSTATE ACCESS

18. Rate Zone Wire Centers18.1 General

This section contains a list of each Telephone Company wire center that has been assigned to a rate zone. Rate zones are applicable to the services specified in Sections 4 and 5. This table lists, by jurisdiction, wire centers assigned to Rate Zones 1, 2, 3, and Price Bands A, B and C, Metropolitan Statistical Area (MSA) and MSA Level.

Metropolitan Statistical Areas (MSAs) may achieve various phases of pricing relief pursuant to Subpart H of the FCC's Part 69 Rules. Telephone Company MSAs which qualify for Phase II pricing relief are identified in this section by MSA Name and level of pricing relief.

(A) Level 1 MSA Pricing

MSAs assigned to a Level 1 pricing are those MSAs which have achieved Phase II pricing relief for all rate elements associated with the portion of the transmission path connecting an Interexchange Carrier's (ICs) customer designated location (CDL) to the wire center serving the secondary CDL, (i.e. end user premises). The rate elements associated with the transmission path are those rate elements applicable for the type of service involved. For example, A High Capacity DS1, as set forth in Section 5, is comprised of special access line, special transport and special transport termination rate elements.

(B) Level 2 MSA Pricing

MSAs assigned to Level 2 pricing are those MSAs which have achieved Phase II pricing relief for all rate elements associated with the end-to-end transmission path connecting the Interexchange Carrier's CDL to the secondary CDL involved. The rate elements associated with the transmission path are those rate elements applicable for the type of service involved.

Applies to All Exchanges Illinois

FACILITIES FOR INTERSTATE ACCESS

18. Rate Zone Wire Centers (Cont'd)

18.1 General (Cont'd)

(B) Level 2 MSA Pricing (Cont'd)

The services which are subject to the MSA rate bands are as follows:

- Voice Grade
- Program Audio
- Digital Data
- High Capacity DS1
- High Capacity DS3
- Clear Channel Capability
- DOVConnect
- Video Digital Transport Service

To determine the pricing zone for the mileage rate element when the wire centers involved are located with different price zones, apply the rates for the higher price zone number. Rates subject to pricing flexibility are noted as Price Band A, B, or C. Traditional Price CAP rates are in Zones 1, 2 and 3. Rates between corresponding zones (1/A- 2/B- 3/C) are maintained for services not awarded pricing flexibility. The MSA Level indicates whether Special Access (SP) may be subject to pricing flexibility band assignment.

Applies to All Exchanges Illinois

FACILITIES FOR INTERSTATE ACCESS

18. Rate Zone Wire Centers (Cont'd)

18.1 General (Cont'd)

The following examples depict the application of the rate elements associated with a typical Special Access Service subject to Level 1 or Level 2 pricing.

Example: Level 1 or 2 pricing at POP SWC to Level 2 pricing at EU SWC

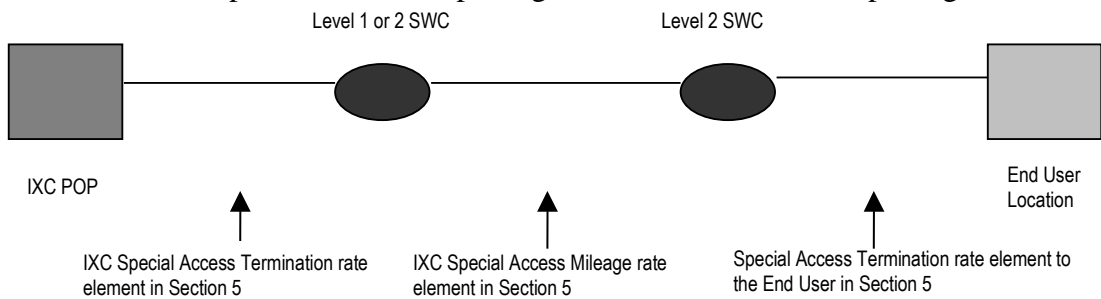

Example: Level 1 or 2 pricing at POP SWC to Level 1 pricing at EU SWC

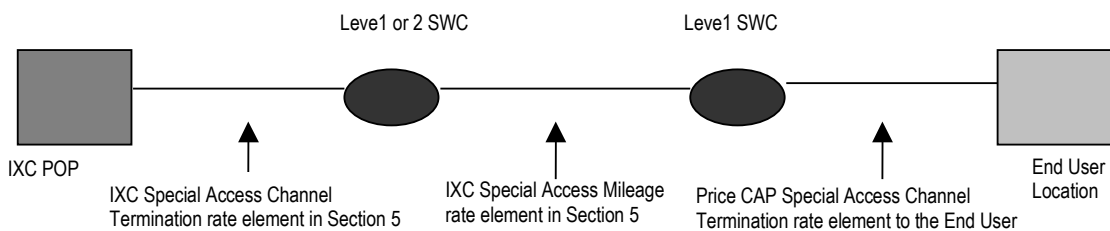

Applies to All Exchanges Illinois

FACILITIES FOR INTERSTATE ACCESS

18. Rate Zone Wire Centers (Cont'd)

18.1 General (Cont'd)

Example: Level 1 or 2 pricing at POP SWC to a Non-qualifying EU SWC

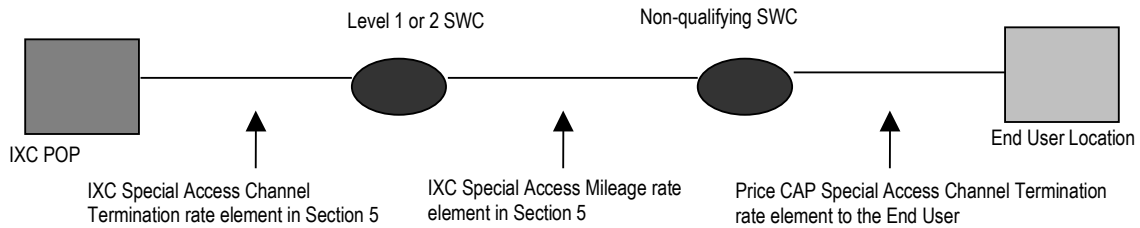

Applies to All Exchanges Illinois

FACILITIES FOR INTRASTATE ACCESS

18. Rate Zone Wire Centers (Cont'd)18.2 Former GTE/Former Alltel Wire Centers

<u>RATE ZONE/ PRICE BAND</u>	<u>CLLI</u>	<u>WIRE CENTER NAME</u>	<u>MSA LEVEL</u>	<u>MSA NAME</u>
1/A	BLTNILXD	BLOOMINGTON		BLOOMINGT
1/A	BLTNILXN	BLOOMINGTON	2 SP	ON
1/A	BLTNILXT	BLOOMINGTON	2 SP	BLOOMINGT
1	CRDLILXE	CARBONDALE	2 SP	ON
1	JCVLILXC	JACKSONVILLE		BLOOMINGT
1	MARNILXE	MARION MAIN		ON
1	MCMBILXD	MACOMB		
1	MRTNILXD	MORTON		
2	ANNAILXE	ANNA		
2	BLVDILXA	BELVIDERE		
2	BNTNILXE	BENTON		
2	BYRNILXA	BYRON		
2	CARVILXE	CARTERVILLE		
2	CHESILXE	CHESTER		
2	CHHMILXC	CHATHAM		
2	CHLCILXD	CHILlicothe		
2	CHVYILXA	CHERRY VALLEY		
2	CLTNILXC	CLINTON		
2	EURKILXD	EUREKA		
2/B	FMCYILXD	FARMER CITY		
2	HGLDILXE	HIGHLAND	2 SP	
2	HRBGILXE	HARRISBURG		
2	HRRNILXE	HERRIN		BLOOMINGT
2	KEWNILXD	KEWANEE		ON
2	LNCLILXC	LINCOLN		
2	LRVLILXE	LAWRENCEVILLE		
2	MHMTILXC	MAHOMET		
2	MNDTILXA	MENDOTA		
2	MNTILXC	MONTICELLO		
2	MRBOILXE	MURPHYSBORO		
2	MRSHILXC	MARSHALL		
2	MTCRILXE	MOUNT CARMEL		
2	MTRPILXE	METROPOLIS		
2	MTZNILXC	MOUNT ZION		
2	NMFRILXA	NEW MILFORD		
2	OLNYILXE	OLNEY		
2	OLNYILXG	OLNEY		
2	PARSILXC	PARIS		
2	PNTCILXA	PONTIAC		
2	PRTNILXA	PRINCETON		
2	PXTNILXC	PAXTON		
2	RNTLILXC	RANTOUL		
2	RBSNILXE	ROBINSON		
2	RCTNILXA	ROCKTON		

Issued: May 10, 2011

Effective: July 1, 2011

By Kenneth Mason
Vice President
of Government and Regulatory Affairs

Applies to All Exchanges Illinois

FACILITIES FOR INTRASTATE ACCESS

18. Rate Zone Wire Centers (Cont'd)18.2 Former GTE/Former Alltel Wire Centers (Cont'd)

<u>RATE ZONE/ PRICE BAND</u>	<u>CLLI</u>	<u>WIRE CENTER NAME</u>	<u>MSA LEVEL</u>	<u>MSA NAME</u>
2	ROSCILXA	ROSCOE		
2	SMNKILXA	SOMONAUK		
2	SNDWILXA	SANDWICH		
2	SPGVILXA	SPRING GROVE		
2	SPVYILXA	SPRING VALLEY		
2	STRILXA	STREATOR		
2	VINNILXE	VIENNA		
2	WASHILXD	WASHINGTON		
2	WNLKILXA	WONDER LAKE		
3	ALBNILXE	ALBION		
3	ALDLILXE	ALLEDALE		
3	ALXNILXG	ALEXANDER		
3	ARGTILXC	ARGENTA		
3	ARMSILXC	ARMSTRONG		
3/C	ARRWILXD	ARROWSMITH		BLOOMINGT ON
3	ASHKILXA	ASHKUM	2 SP	
3	ASTRILXD	ASTORIA		
3/C	ATLNILXC	ATLANTA		
3	AUBNILXC	AUBURN	2 SP	BLOOMINGT ON
3	AVA ILXE	AVA		
3	BARYILXC	BARRY		
3	BESNILXC	BEASON		
3	BCKLILXC	BUCKLEY		
3	BEMTILXE	BELLMONT		
3	BKPTILXE	BROOKPORT		
3/C	BLFLILXD	BELLFLOWER		
3	BLFSILXC	BLUFFS	2 SP	
3	BDVLILXC	BONDVILLE		BLOOMINGT ON
3	BMFDILXD	BRIMFIELD		
3	BMNTILXC	BEMENT		
3	BNSNILXD	BENSON		
3	BRFRILXA	BRADFORD		
3	BRLDILXC	BROADLANDS		
3	BRPRILXE	BURNT PRAIRIE		
3	BRPTILXE	BRIDGEPORT		
3	BRTNILXC	BROCTON		
3	BSHNILXD	BUSHNELL		
3	BTHNILXC	BETHANY		
3	BUDAILXD	BUDA		
3	BUREILXA	BUREAU		
3	BVVLILXA	BEAVERVILLE		
3	BYLSILXC	BAYLIS		
3	CARMILXE	CARMI		
3	CBDNILXE	COBDEN		
3	CBRYILXA	CABERY		

Issued: May 10, 2011

Effective: July 1, 2011

By Kenneth Mason
Vice President
of Government and Regulatory Affairs

Applies to All Exchanges Illinois

FACILITIES FOR INTRASTATE ACCESS

18. Rate Zone Wire Centers (Cont'd)18.2 Former GTE/Former Alltel Wire Centers (Cont'd)

<u>RATE ZONE/ PRICE BAND</u>	<u>CLLI</u>	<u>WIRE CENTER NAME</u>	<u>MSA LEVEL</u>	<u>MSA NAME</u>
3	CFTNILXA	CLIFTON		
3	CHAPILXC	CHAPIN		
3	CHBNILXA	CHEBANSE		
3/C	CHENILXA	CHENOA		BLOOMINGTON
3	CHRSILXC	CHRISMAN	2 SP	
3	CHRTILXE	CHRISTOPHER		
3	CHWOILXA	CHATSWORTH		
3	CISCILXC	CISCO		
3/C	CLFXILXD	COLFAX		BLOOMINGTON
3	CLSNILXC	COLLISON	2 SP	
3	CLMTILXE	CLAREMONT		
3	CLSPILXE	CREAL SPRINGS		
3	CMGVILXE	CAMP GROVE		
3	CMPNILXC	CAMP POINT		
3	CMPSILXA	CAMPUS		
3	CASYILXC	CASEY		
3	CMTNILXA	COMPTON		
3	CPRNILXA	CAPRON		
3	CRGRILXC	CERRO GORDO		
3/C	CRLCILXD	CARLOCK		BLOOMINGTON
3	CRMLILXE	CARRIER MILLS	2 SP	
3	CYVLILXC	CHENEYVILLE		
3/C	CRPSILXD	CROSEY		BLOOMINGTON
3	CRTNILXC	CARROLLTON	2 SP	
3	CSTNILXD	CASTELTON		
3	CGVLILXD	CONGERVILLE		
3	CTVLILXE	COULTERVILLE		
3	CUBAILXD	CUBA		
3	CSPKILXA	CISSNA PARK		
3	CYCYILXE	CLAY CITY		
3	CYPRILXE	CYPRESS		
3	CYTNILXC	CLAYTON		
3	DNFTILXA	DANFORTH		
3	DELDILXC	DE LAND		
3	DESTILXE	DE SOTO		
3	DRCKILXD	DEER CREEK		
3	DNLPIILD	DUNLAP		
3	DNVNILXA	DONOVAN		
3	DONGILXE	DONGOLA		
3	DOVRILXA	DOVER		
3	DTCYILXC	DALTON CITY		
3	DUQNILXE	DUQUOIN		
3	DVRNILXC	DIVERNON		
3/C	DWNSILXD	DOWNS		BLOOMINGTON
3	ELYNILXC	EAST LYNN	2 SP	

Issued: May 10, 2011

Effective: July 1, 2011

By Kenneth Mason
Vice President
of Government and Regulatory Affairs

Applies to All Exchanges Illinois

FACILITIES FOR INTRASTATE ACCESS

18. Rate Zone Wire Centers (Cont'd)18.2 Former GTE/Former Alltel Wire Centers (Cont'd)

<u>RATE ZONE/ PRICE BAND</u>	<u>CLLI</u>	<u>WIRE CENTER NAME</u>	<u>MSA LEVEL</u>	<u>MSA NAME</u>
3	EDLSILXD	EDELSTEIN		
3	EKHTILXC	ELKHART		
3	EKVLILXE	ELKVILLE		
3	ELDDILXC	ELDRED		
3	ELLGILXE	ELLIS GROVE		
3	ELLTILXC	ELLIOTT		
3	ELRDILXE	ELDORADO		
3	ELWNILXC	ELWIN		
3/C	ELWOILXD	ELLSWORTH	2 SP	BLOOMINGTON
3	EMIRILXD	ELMIRA		
3	EMTNILXA	EMINGTON		
3	EMWDILXD	ELMWOOD		
3	EMDNILXC	EMDEN		
3	ENFDILXE	ENFIELD		
3	ERVLILXA	EARLVILLE		
3	EVVLILXE	EVANSVILLE		
3	EWNGILXE	EWING		
3	FKLNILXC	FRANKLIN		
3	FSHRILXC	FISHER		
3	FLORILXE	FLORA		
3/C	FRBRILXA	FAIRBURY	2 SP	BLOOMINGTON
3	FRFDILXE	FAIRFIELD		
3	FLVLILXC	FLATVILLE		
3	FSLDILXC	FOOSLAND		
3	GDRGILXA	GRAND RIDGE		
3	GGVLILXC	GRIGGSVILLE		
3	GLCNILXE	GOLCONDA		
3	GDFDILAB	GOODFIELD		
3	GFFRILXC	GIFFORD		
3	GNFDILXC	GREENFIELD		
3	GNTRILXE	GRAND TOWER		
3	GNUPILXC	GREENUP		
3	GRPRILXA	GARDEN PRAIRIE		
3	GRRDILXC	GIRARD		
3	GRVLILXE	GOREVILLE		
3	GVDILXD	GROVELAND		
3	GYVLILXE	GRAYVILLE		
3	HTBGILXC	HARTSBURG		
3	HBRNILXA	HEBRON		
3/C	HDSNILXD	HUDSON	2 SP	BLOOMINGTON
3	HLVWILXC	HILLVIEW		
3	HMNDILXC	HAMMOND		

Issued: May 10, 2011

Effective: July 1, 2011

By Kenneth Mason
Vice President
of Government and Regulatory Affairs

Applies to All Exchanges Illinois

FACILITIES FOR INTRASTATE ACCESS

18. Rate Zone Wire Centers (Cont'd)18.2 Former GTE/Former Alltel Wire Centers (Cont'd)

<u>RATE ZONE/ PRICE BAND</u>	<u>CLLI</u>	<u>WIRE CENTER NAME</u>	<u>MSA LEVEL</u>	<u>MSA NAME</u>
3	HNPILXB	HENNEPIN		
3	HNRYLXD	HENRY		
3	HOMRILXC	HOMER		
3	HPDLILXD	HOPEDALE		
3	HPTNILXC	HOOPESTON		
3	HRSTILXE	HURST		
3	HULLILAA	HULL		
3/C	HYWOILXD	HEYWORTH	2 SP	BLOOMINGTON
3	ILPLILXC	ILLIOPOLIS		
3	IVDLILXC	IVESDALE		
3	JHCYILXE	JOHNSTON CITY		
3	JOPPILXE	JOPPA		
3	KNSSILXC	KANSAS		
3	KNNYILXC	KENNEY		
3	KRNKILXE	KARNAK		
3	LADDILXA	LADD		
3	LAMLILXA	LAMOILLE		
3	LAPLILXC	LAPLACE		
3	LARSILXD	LAROSE		
3	LELDILXB	LELAND		
3	LGNILXA	LONG POINT		
3	LOAMILXC	LOAMI		
3	LODAILXC	LODA		
3/C	LROYILXD	LEROY	2 SP	BLOOMINGTON
3	LSTNILXA	LOSTANT		
3	LTRBILXC	LITERBERRY		
3/C	LXTNILXD	LEXINGTON	2 SP	BLOOMINGTON
3	LDLWILXC	LUDLOW		
3	MACNILXC	MACON		
3	MARNILXS	MARION SOUTH		
3	MAROILXC	MAROA		
3	MAUNILXE	MAUNIE		
3	MCBOILXE	MCLEANSBORO		
3	MCKNILXD	MACKINAW		
3/C	MCLNILXD	MCLEAN	2 SP	BLOOMINGTON
3	MGNLILXA	MAGNOLIA		
3	MINRILXD	MINIER		
3	MLFRILXA	MILFORD		
3	MLTNILXC	MILTON		
3	MLVNILXC	MELVIN		
3	MNCHILXC	MANCHESTER		
3/C	MNFDILXC	MANSFIELD	2 SP	BLOOMINGTON
3	MNLSILXA	MANLIUS		
3	MNNKILXD	MINONK		

Issued: May 10, 2011

Effective: July 1, 2011

By Kenneth Mason
Vice President
of Government and Regulatory Affairs

Applies to All Exchanges Illinois

FACILITIES FOR INTRASTATE ACCESS

18. Rate Zone Wire Centers (Cont'd)18.2 Former GTE/Former Alltel Wire Centers (Cont'd)

<u>RATE ZONE/ PRICE BAND</u>	<u>CLLI</u>	<u>WIRE CENTER NAME</u>	<u>MSA LEVEL</u>	<u>MSA NAME</u>
3	MNRLILXD	MINERAL		
3	MRDSILXC	MEREDOSIA		
3	MRSSILXE	MARISSA		
3	MSVLILXD	MOSSVILLE		
3	MTCFILXC	METCALF		
3	MTSTILXC	MOUNT STERLING		
3	MTTNILXA	MARTINTON		
3	MUVLILXC	MURRAYVILLE		
3	NCTNILXC	NEW CANTON		
3	NHLDILXC	NEW HOLLAND		
3	NEOGILXC	NEOGA		
3	NINTILXC	NIANTIC		
3	NOBLILXE	NOBLE		
3	NPNSILXD	NEPONSET		
3	NWBLILXC	NEW BERLIN		
3	NWMNILXC	NEWMAN		
3	NWTNILXE	NEWTON		
3	ODLLILXA	ODELL		
3	OGDNILXC	OGDEN		
3	OHIOILXA	OHIO		
3	ORENILXC	OREANA		
3	PASNILXC	PATTERSON		
3	PAWNILXC	PAWNEE		
3	PERCILXE	PERCY		
3	PERLILXC	PEARL		
3	PNFDILXC	PENFIELD		
3	PSTMILXC	PESOTUM		
3	PHILILXC	PHILO		
3	PLHLILXC	PLEASANT HILL		
3	PLMYILXC	PALMYRA		
3	PLPLILXC	PLEASANT PLAINS		
3	PPCYILXA	PIPER CITY		
3	PPGVILXA	POPLAR GROVE		
3	PTMCILXC	POTOMAC		
3	PRCYILXD	PRAIRIE CITY		
3	PRNVILXD	PRINCEVILLE		
3	PRRYILXD	PERRY		
3	PTFDILXC	PITTSFIELD		
3	PWPWILXA	PAW PAW		
3	PYVLILXE	PINCKNEYVILLE		
3	RNKNILXC	RANKIN		
3	RBRTLXC	ROBERTS		
3	RCKTILXA	ROCK CUT		
3	RCMDILXA	RICHMOND		
3	RCPTILXC	ROCKPORT		
3	RDDCILXA	REDDICK		

Issued: May 10, 2011

Effective: July 1, 2011

By Kenneth Mason
Vice President
of Government and Regulatory Affairs

Applies to All Exchanges Illinois

FACILITIES FOR INTRASTATE ACCESS

18. Rate Zone Wire Centers (Cont'd)18.2 Former GTE/Former Alltel Wire Centers (Cont'd)

<u>RATE ZONE/ PRICE BAND</u>	<u>CLLI</u>	<u>WIRE CENTER NAME</u>	<u>MSA LEVEL</u>	<u>MSA NAME</u>
3	RDHSILXC	ROODHOUSE		
3	ROYLILXC	ROYAL		
3	RDMNILXC	REDMON		
3	RGWYILXE	RIDGWAY		
3	RONKILXD	ROANOKE		
3	RSHLILXE	ROSEHILL		
3	RTLDILXA	RUTLAND		
3	RYTNILXE	ROYALTON		
3	SDRSILXC	SADURUS		
3	SYMRILXC	SEYMOUR		
3	SECRILXD	SECOR		
3	SBLYLXC	SIBLEY		
3	SDLLILXC	SIDELL		
3	SDNYILXC	SIDNEY		
3	SFVLILXE	ST. FRANCISVILLE		
3	SHFDILXA	SHEFFIELD		
3	SHLDILXA	SHIRLAND		
3	SHLNILXA	SHELDON		
3	SHMNILXC	SHERMAN		
3	SHRDILXA	SHERIDAN		
3	SHTWILXE	SHAWNEETOWN		
3	SLLVILXC	SULLIVAN		
3	SMNRILXE	SUMNER		
3	SNLDILXD	SUNNYLAND		
3	SPLDILXD	SPARLAND		
3	SPRTLXE	SPARTA		
3	SSSRILXE	SESSER		
3/C	STFRILXD	STANFORD	2 SP	BLOOMINGTON
3	STLDILXA	STOCKLAND		
3	STFTILXE	STONEFORT		
3	STRWILXA	STRAWN		
3	STVYILXA	STILLMAN VALLEY		
3/C	SYBKILXD	SAYBROOK	2 SP	BLOOMINGTON
3	TLDNILXE	TILDEN		
3	THBOILXC	THOMASBORO		
3	TOLDILXC	TOLEDO		
3	TLONILXC	TOLONO		
3	TOLCILXA	TOLUCA		
3	TOLNILXD	TOULON		
3	TPVLILXE	THOMPSONVILLE		
3	TRMTILXD	TREMONT		
3	TSCLILXC	TUSCOLA		
3	TSKLILXA	TISKILWA		

Issued: May 10, 2011

Effective: July 1, 2011

By Kenneth Mason
Vice President
of Government and Regulatory Affairs

Applies to All Exchanges Illinois

FACILITIES FOR INTRASTATE ACCESS

18. Rate Zone Wire Centers (Cont'd)18.3 Former GTE/Former Alltel Wire Centers (Cont'd)

<u>RATE ZONE/ PRICE BAND</u>	<u>CLLI</u>	<u>WIRE CENTER NAME</u>	<u>MSA LEVEL</u>	<u>MSA NAME</u>
3	TWVLILXC	THAWVILLE		
3	ULLNILXE	ULLIN		
3	VARNILXD	VARNA		
3	VLGVILXC	VILLA GROVE		
3	VLRGILXE	VILLA RIDGE		
3	VRDNILXC	VIRDEN		
3	VRMLILXC	VERMILION		
3	VRMTILXD	VERMONT		
3	VRSLILXC	VERSAILLES		
3	WBRKILXA	WEST BROOKLYN		
3	WDSNILXG	WOODSON		
3	WENNILXA	WENONA		
3	WFFTILXE	WEST FRANKFORT		
3	WHHAILXC	WHITE HALL		
3	WLDNILXC	WELDON		
3	WLNTILXA	WALNUT		
3	WNCHILXC	WINCHESTER		
3	WNNBILXA	WINNEBAGO		
3	WRBGILXC	WARRENSBURG		
3	WSBNILXD	LOW POINT		
3	WSPTILXE	WESTPORT		
3	WSVLILXC	WILLIAMSVILLE		
3	WUNNILXC	WEST UNION		
3	WVRLILXC	WAVERLY		
3	WGTNILXA	WELLINGTON		
3	WWHLILXE	WILLOW HILL		
3	WYCYILXE	WAYNE CITY		
3	WSFDILXC	WESTFIELD		
3	WDLDILXA	WOODLAND		
3	WYNGILXD	WYOMING		
3	WYNTILXA	WYANET		
3	WYVLILXC	WAYNESVILLE		
3	ZGLRILXF	ZEIGLER		

Issued: May 10, 2011

Effective: July 1, 2011

By Kenneth Mason
Vice President
of Government and Regulatory Affairs

Applies to All Exchanges Illinois

FACILITIES FOR INTRASTATE ACCESS

18. Rate Zone Wire Centers (Cont'd)18.3 Former Contel Wire Centers

<u>RATE ZONE/ PRICE BAND</u>	<u>CLLI</u>	<u>WIRE CENTER NAME</u>	<u>MSA LEVEL</u>	<u>MSA NAME</u>
1	DKLBILXA	DEKALB		
1	FRPTILXA	FREEMONT		
1	SYCMILXA	SYCAMORE		
2	GENOILXA	GENOA		
2	MSCTILXE	MASCOUTAH		
2	ORGNILXA	OREGON		
2	RCHEILXA	ROCHELLE		
3	ACLKILXA	APPLE CANYON LAKE		
3	ALBRILXE	ALBERS		
3	ALVNILXC	ALVIN		
3	AMBYILXA	AMBOY		
3	ANNPILXE	ANNAPOLIS		
3	APRVILXA	APPLE RIVER		
3	ASTNILXA	ASHTON		
3	BRDSILXE	BIRDS		
3	BSMRILXC	BISMARCK		
3	CDPNILXA	CEDAR POINT		
3	CDVLILXA	CEDARVILLE		
3	CETNILXA	CRESTON		
3	CHNCILXE	CHAUNCEY		
3	CLHNILXE	CALHOUN		

Applies to All Exchanges Illinois

FACILITIES FOR INTRASTATE ACCESS

18. Rate Zone Wire Centers (Cont'd)18.3 Former Contel Wire Centers (Cont'd)

<u>RATE ZONE/ PRICE BAND</u>	<u>CLLI</u>	<u>WIRE CENTER NAME</u>	<u>MSA LEVEL</u>	<u>MSA NAME</u>
3	DAKTILXA	DAKOTA		
3	DAVSILXA	DAVIS		
3	DNDSILXE	DUNDAS		
3	DRNDILXA	DURAND		
3	ELZBILXA	ELIZABETH		
3	FNGVILXA	FRANKLIN GROVE		
3	FSTNILXA	FORRESTON		
3	FYVLILXE	FAYETTEVILLE		
3	GALVILXD	GALVA		
3	GRPRILXA	GARDEN PRAIRIE		
3	GRVILXA	GRANVILLE		
3	GRVYILXA	GERMAN VALLEY		
3	HAVLILXE	HARDINVILLE		
3	HCKRILXE	HECKER		
3	HNCKILXA	HINCKLEY		
3	HNNGILXC	HENNING		
3	HNVRILXA	HANOVER		
3	HTSVILXE	HUTSONVILLE		

Applies to All Exchanges Illinois

FACILITIES FOR INTRASTATE ACCESS

18. Rate Zone Wire Centers (Cont'd)18.3 Former Contel Wire Centers (Cont'd)

<u>RATE ZONE/ PRICE BAND</u>	<u>CLLI</u>	<u>WIRE CENTER NAME</u>	<u>MSA LEVEL</u>	<u>MSA NAME</u>
3	KRLDILXA	KIRKLAND		
3	LENAILXA	LENA		
3	MALTILXA	MALTA		
3	MAPKILXA	MAPLE PARK		
3	MCCNILXA	MCCONNEL		
3	MLSTILXE	MILLSTADT-WESTVIEW		
3	MNCTILXA	MONROE CENTER		
3	MSBCILXA	MASSBACH		
3	MTMRILXA	MT. MORRIS		
3	NRCYILXE	NORRIS CITY		
3	NWBDILXE	NEW BADEN		
3	NWHNILXE	NEW HAVEN		
3	OGVLILXA	ORANGEVILLE		
3	OKVLILXE	OKAWVILLE		
3	OMAHILXE	OMAHA		
3	PCTNILXA	PECATONICA		
3	PLCYILXA	PEARL CITY		
3	PLSTILXE	PALESTINE		
3	PRBGILXE	PARKERSBURG		

Applies to All Exchanges Illinois

FACILITIES FOR INTRASTATE ACCESS

18. Rate Zone Wire Centers (Cont'd)18.3 Former Contel Wire Centers (Cont'd)

<u>RATE ZONE/ PRICE BAND</u>	<u>CLLI</u>	<u>WIRE CENTER NAME</u>	<u>MSA LEVEL</u>	<u>MSA NAME</u>
3	PTNMILXD	PUTNAM		
3	RLGHILXE	RALEIGH-GALATIA		
3	ROVLILXC	ROSSVILLE		
3	SBLTILXA	SUBLETTE		
3	SCMNILXA	SCALES MOUND		
3	SHBNILAA	SHABBONA ROAD		
3	SKTNILXA	STOCKTON		
3	SLSPILXE	SAILOR SPRINGS		
3	SRFDILXE	SUMMERFIELD		
3	STWRILXA	STEWARD		
3	SWRDILXA	SEWARD		
3	WNDNILXE	WENDELIN		
3	WNSLILXA	WINSLOW		
3	WRRNILXA	WARREN		
3	WSLMILXE	WEST SALEM		
3	WSVWILAB	WESTVIEW/VILLA		
3	WTMNILXA	WATERMAN		

Applies to All Exchanges Illinois

FACILITIES FOR INTERSTATE ACCESS

SECTION 19 TABLE OF CONTENTS

	<u>Page</u>
19. <u>Contract Tariffs</u>	
19.1 General	2

Applies to All Exchanges Illinois

FACILITIES FOR INTERSTATE ACCESS

19. Contract Tariffs

This section contains terms and conditions and rates and charges for contract tariffs provided by the Telephone Company.

19.1 General

Contract tariffs apply in Metropolitan Statistical Areas (MSAs) which are eligible for Phase I and Phase II Pricing Flexibility. MSAs that are eligible for Phase II Pricing Flexibility are further subject to Level I and Level 2 MSA pricing.

Contract Tariffs are subject to the regulations specified in all other sections of this tariff, unless otherwise specified.

Applies to All Exchanges Illinois

FACILITIES FOR INTRASTATE ACCESS

SECTION 20 TABLE OF CONTENTS

<u>20. Operating Territories of Frontier North Inc. and Concurring Telephone Companies</u>	<u>Page</u>
20.1 Operating Territory of Frontier North Inc.	2
20.2 Operating Territory of Frontier Communications of the Carolinas Inc...	6

 Applies to All Exchanges Illinois

20. Operating Territories of Frontier North Inc. and Concurring Telephone Companies20.1 Operating Territory of Frontier North Inc.

The operating territory of Frontier North Inc., defined by the names of rate centers, is comprised of the following locations for Illinois,:

(A) Operating Territory of Illinois – Concurs in Frontier Telephone Companies FCC No. 15, Section 4 , Terms and Conditions.(1015)

Albion	Cabery	Dalton City
Alexander	Camp Grove	De Land
Allendale	Camp Point	De Soto
Anna	Campus	Divernon
Argenta	Capron	Dongola
Ashkum	Carbondale	Donovan
Astoria	Carlock	Donovan
Atlanta	Carmi	Dover
Auburn	Carriers Mills	Downs
Ava	Carrollton	Dunlap
Barry	Carterville	Du Quoin
Baylis	Castleton	Earlville
Beaverville	Cerro Gordo	Edelstein
Bellflower	Chapin	Eldorado
Bellmont	Chatham	Eldred
Belvidere	Chatsworth	Elkhart
Bement	Chebense	Elkville
Benson	Chenoa	Elliot
Benton	Cherry Valley	Ellis Grove
Bethany	Chester	Ellsworth
Bloomington	Chillicothe	Elmira
Bluffs	Chrisman	Elmwood
Bradford	Christopher	Elwin
Bridgeport	Cisco	Emington
Brimfield	Claremont	Enfield
Broadlands	Clay City	Eureka
Brocton	Clayton	Evansville
Brookport	Clifton	Ewing
Buckley	Clinton	
Buda	Cobden	
Bureau	Colfax	
Burnt Prairie	Compton	
Bushnell	Coulterville	
Byron	Creal Springs	
	Cropsey	
	Cuba	
	Cypress	

Applies to All Exchanges Illinois

20. Operating Territories of Frontier North Inc. and Concurring Telephone Companies (Cont'd)

20.1 Operating Territory of Frontier North Inc. (Cont'd)

(A) Operating Territory of Illinois – Concurs in Frontier Telephone Companies FCC No. 15, Section 4
 Terms and Conditions.(OCN - 1015) (Cont'd)

Fairbury	Jacksonville	McLean
Fairfield	Johnston City	McLeansboro
Farmer City	Joppa	Melvin
Flora	Karnak	Mendota
Franklin	Kenney	Meredosia
Garden Prairie	Kewanee	Metcalf
Girard	Ladd	Metropolis
Golconda	La Moille	Middletown
Goreville	La Place	Milton
Grand Ridge	La Rose	Mineral
Grayville	Lawrenceville	Minier
Greenfield	Leland	Minonk
Griggsville	Le Roy	Monticello
Groveland	Lexington	Morton
Hammond	Lincoln	Mossville
Harrisburg	Literberry	Mount Carmel
Hebron	Loami	Mount Sterling
Hennepin	Loda	Mount Zion
Henry	Long Point	Murphysboro
Herrin	Lostant	Murrayville
Heyworth	Low Point	Neponset
Highland	Mackinaw	New Berlin
Hillview	Macomb	New Canton
Homer	Macon	New Milford
Hopedale	Magnolia	Newman
Hudson	Mahomet	Newton
Hull	Manchester	Niantic
Hurst	Manlius	Noble
Illiopolis	Mansfield	Odell
	Marion	Ohio
	Marissa	Olney
	Maroa	Oreana
	Marshall	
	Martinton	
	Maunie	

Applies to All Exchanges Illinois

20. Operating Territories of Frontier North Inc. and Concurring Telephone Companies (Cont'd)20.1 Operating Territory of Frontier North Inc. (Cont'd)(A) Operating Territory of Illinois – Concurs in Frontier Telephone Companies FCC No. 15, Section 4 , Terms and Conditions.(OCN - 1015) (Cont'd)

Palmyra	Saint Francisvilla	Ullin
Paris	Sandwich	Varna
Patterson	Saybrook	Vermilion
Paw Paw	Sesser	Vermont
Pawnee	Shawneetown	Versailles
Paxton	Sheffield	Vienna
Pearl	Sheldon	Villa Grove
Percy	Sheridan	Villa Ridge
Perry	Sherman	Virden
Pinckneyville	Shirland	Walnut
Piper City	Sibley	Warrensburg
Pittsfield	Sidell	Washburn
Pleasant Hill	Sidney	Washington
Pleasant Plains	Somonauk	Waverly
Pontiac	Sparland	Wayne City
Poplar Grove	Sparta	Waynesville
Prairie City	Spring Grove	Weldon
Princeton	Spring Valley	Wenona
Reddick	Stanford	West Brooklyn
Redmon	Stelleville	West Frankfort
Princeville	Stillman Valley	West Union
Richmond	Stonefort	Westport
Ridgway	Strawn	Westview
Roanoke	Streator	White Hall
Roberts	Sullivan	Williamsville
Robinson	Sumner	Willow Hill
Rock Cut	Sunnyland	Winchester
Rockport	Thawville	Winnebago
Rockton	Thompsonville	Wonder Lake
Roodhouse	Tilden	Woodson
Roscoe	Tiskilwa	Wyanet
Rose Hill	Toluca	Wyoming
Royalton	Toulon	Zeigler
Rutland	Tremont	
	Tuscola	

Applies to All Exchanges Illinois

20. Operating Territories of Frontier North Inc. and Concurring Telephone Companies20.1 Operating Territory of Frontier North Inc.(B) Operating Territory of Illinois – Concurr in Frontier Telephone Companies FCC No. 15, Section 4, Terms and Conditions.(OCN - 1015) (OCN - 1036)

Albers	Granville	Pectaonica
Alvin	Hanover	Putnam
Amboy	Hardinville	Raleigh
Annapolis	Hecker	Rochelle
Apple Canyon	Henning	Rossville
Apple River	Hinckley	Sailor Springs
Ashton	Hutsonville	Scales Mound
Birds	Kirkland	Seward
Bismarck	Lena	Shabbona
Calhoun	Malta	Steward
Cedar Point	Maple Park	Stockton
Cedarville	Mascoutah	Sublette
Chauncey	Massbach	Summerfield
Creston	McConnell	Sycamore
Dakota	Millstadt	Warren
Davis	Monroe Center	Waterman
Dekalb	Mount Morris	Wendelin
Dundas	New Baden	West Salem
Durand	New Haven	Winslow
Elizabeth	Norris City	
Fayetteville	Okwaville	
Forreston	Omaha	
Franklin Grove	Orangeville	
Freeport	Oregon	
Galva	Palestine	
Genoa	Parkersburg	
German Valley	Paulton	
	Pearl City	

Issued: June 29, 2012

Effective: July 1, 2012

By Kenneth Mason
Vice President
of Government and Regulatory Affairs

Applies to All Exchanges Illinois

20. Operating Territories of Frontier North Inc. and Concurring Telephone Companies (Cont'd)

20.2 Operating Territory of Frontier Communications of the Carolinas Inc.

(A) Operating Territory of Illinois – Operating Territory of Illinois – Concurs in Frontier Telephone Companies FCC No. 15, Section 4 , Terms and Conditions.(OCN - 1015) (OCN - 1000)

Armstrong	Stockland
Beason	Thomasboro
Bondville	Toledo
Casey	Tolono
Cheneyville	Wellington
Cissna Park	Westfield
Collison	Woodland
Congerville	
Danforth	
Deer Creek	
East Lynn	
Emden	
Fisher-Dewey	
Flatville	
Foosland	
Gifford	
Goodfield	
Greenup	
Hartsburg	
Hoopeston	
Ivesdale	
Kansas	
Ludlow	
Milford	
Neoga	
Ogden	
Penfield	
Pesotum	
Philo	
Potomac	
Rankin	
Rantoul	
Royal	
Sadorus	
Secor	
Seymour	